



SERVICE MANUAL

HF TRANSCEIVER

IC-737

INTRODUCTION

This service manual describes the latest service information for the **IC-737** HF TRANSCEIVER at the time of publication.

VERSION NO.	VERSION	SYMBOL
#02	Other	OTH
#03	France	FRA

To upgrade quality, all electrical or mechanical parts and internal circuits are subject to change without notice or obligation.

DANGER

NEVER connect the transceiver to an AC outlet or to a DC power supply that uses more than 16 V. This will ruin the transceiver.

DO NOT expose the transceiver to rain, snow or any liquids.

DO NOT reverse the polarities of the power supply when connecting the transceiver.

DO NOT apply an RF signal of more than 20 dBm (100 mW) to the antenna connector. This could damage the transceiver's front end.



ORDERING PARTS

Be sure to include the following four points when ordering replacement parts:

1. 10-digit order numbers
2. Component part number and name
3. Equipment model name and unit name
4. Quantity required

<SAMPLE ORDER>

1790000050 IC ND487C1-3R IC-737 MAIN UNIT 5 pieces
8810002260 Screw FH B0 M3×6 IC-737 Chassis 10 pieces

Addresses are provided on the inside back cover for your convenience.

REPAIR NOTES

1. Make sure a problem is internal before disassembling the transceiver.
2. **DO NOT** open the transceiver until the transceiver is disconnected from its power source.
3. **DO NOT** force any of the variable components. Turn them slowly and smoothly.
4. **DO NOT** short any circuits or electronic parts. An insulated tuning tool **MUST** be used for all adjustments.
5. **DO NOT** keep power ON for a long time when the transceiver is defective.
6. **DO NOT** transmit power into a signal generator or a sweep generator.
7. **ALWAYS** connect a 50 dB to 60 dB attenuator between the transceiver and a deviation meter or spectrum analyzer when using such test equipment.
8. **READ** the instructions of test equipment thoroughly before connecting equipment to the transceiver.

TABLE OF CONTENTS

SECTION 1	SPECIFICATIONS	1 - 1
SECTION 2	DISASSEMBLY INSTRUCTIONS	2 - 1 to 3
2 - 1	REMOVING THE PA BLOCK	2 - 1
2 - 2	REMOVING THE ANTANNA TUNER	2 - 2
2 - 3	CONNECTOR LOCATIONS	2 - 3
SECTION 3	INSIDE VIEWS	3 - 1 to 2
SECTION 4	CIRCUIT DESCRIPTION	4 - 1 to 12
4 - 1	RECEIVER CIRCUITS	4 - 1
4 - 2	TRANSMITTER CIRCUITS	4 - 5
4 - 3	PLL CIRCUITS	4 - 8
4 - 4	LOGIC CIRCUITS	4 - 9
4 - 5	ANTENNA TUNER CIRCUITS	4 - 11
4 - 6	REGULATOR CIRCUITS	4 - 12
SECTION 5	ADJUSTMENT PROCEDURES	5 - 1 to 13
5 - 1	PREPARATION BEFORE SERVICING	5 - 1
5 - 2	PLL ADJUSTMENT	5 - 2
5 - 3	RECEIVER ADJUSTMENT	5 - 4
5 - 4	TRANSMITTER ADJUSTMENT	5 - 8
5 - 5	ANTENNA TUNER ADJUSTMENT	5 - 13
SECTION 6	PARTS LIST	6 - 1 to 24
SECTION 7	MECHANICAL PARTS	7 - 1 to 4
7 - 1	FRONT AND CABINET PARTS	7 - 1
7 - 2	CHASSIS PARTS AND ACCESSORIES	7 - 3
SECTION 8	BOARD LAYOUTS	8 - 1 to 10
8 - 1	MAIN UNIT	8 - 1
8 - 2	LOGIC UNIT	8 - 3
8 - 3	PLL UNIT	8 - 3
8 - 4	SW AND DISPLAY UNITS	8 - 5
8 - 5	CTRL UNIT	8 - 6
8 - 6	TUNE AND ELEKEY UNITS	8 - 8
8 - 7	FILTER UNIT	8 - 9
8 - 8	PA UNIT	8 - 10
SECTION 9	BLOCK DIAGRAM	9 - 1
SECTION 10	VOLTAGE DIAGRAM	10 - 1 to 4

SECTION 1 SPECIFICATIONS

■ GENERAL

- Frequency coverage : Receive 500 kHz-29.995 MHz
Transmit 1.800-1.99999 MHz 3.500-4.000 MHz
7.000-7.300 MHz 10.100-10.150 MHz
14.000-14.350 MHz 18.069-18.168 MHz
21.000-21.450 MHz 24.890-24.990 MHz
28.000-29.700 MHz
- Mode : SSB, CW, AM, FM
- Number of memory channels : 101
- Antenna impedance : 50 Ω nominal
- Usable temperature range : -10 °C to +60 °C (+14 °F to +140 °F)
- Frequency stability : Less than ± 200 Hz from 1 min. to 60 min. after power ON
Less than ± 30 Hz/hr. after one hour at +25 °C (+77 °F)
Temperature fluctuations (0 °C to +50 °C; +32 °F to +122 °F) less than ± 350 Hz
- Power supply requirement : 13.8 V DC $\pm 15\%$ (20 A)
- Current drain (at 13.8 V DC) : Transmit 20 A
Receive squelched 1.6 A
max. audio output 2.1 A
- Dimensions : 330 (W) \times 111 (H) \times 285 (D) mm
13.0 (W) \times 4.4 (H) \times 11.2 (D) in
(Projections not included)
- Weight : 8.05 kg (17.7 lb)

■ TRANSMITTER

- Output power : SSB, CW, FM 10-100 W
AM 10-40 W
(continuously adjustable)
- Spurious emissions : Less than -50 dB
- Carrier suppression : More than 40 dB
- Unwanted sideband suppression : More than 50 dB
- Microphone impedance : 600 Ω

■ RECEIVER

- Receive system : Triple-conversion superheterodyne
- Intermediate frequency :

MODE	1st	2nd	3rd
SSB	69.0115 MHz	9.0115 MHz	455 kHz
CW	69.0106 MHz	9.0106 MHz	455 kHz
AM, FM	69.0100 MHz	9.0100 MHz	455 kHz
- Sensitivity (Preamp ON) : SSB, CW (10 dB S/N) 1.8-29.995 MHz Less than 0.16 μ V
AM (10 dB S/N) 0.5-1.8 MHz Less than 13.0 μ V
1.8-29.995 MHz Less than 2.0 μ V
FM (12 dB SINAD) 28-29.7 MHz Less than 0.5 μ V
- Squelch sensitivity (Threshold) : SSB Less than 5.6 μ V
FM Less than 0.3 μ V
- Selectivity : SSB, CW More than 2.1 kHz/-6 dB Less than 4.0 kHz/-60 dB
AM More than 6.0 kHz/-6 dB Less than 20.0 kHz/-40 dB
FM More than 12.0 kHz/-6 dB Less than 30.0 kHz/-50 dB
- Spurious and image rejection ratio : More than 70 dB
- Audio output power : More than 2.6 W with an 8 Ω load
- RIT variable range : ± 1.25 kHz or ± 2.5 kHz selectable

■ ANTENNA TUNER

- Matching impedance range : 16.7-150 Ω unbalanced (less than VSWR 3 : 1)
- Minimum operating input : 8 W
- Waiting time for band changing : Less than 3 sec.
(typical)
- Tuning time (typical) : Less than 7 sec.
- Tuning accuracy : VSWR 1.5 : 1 or less
- Insertion loss (after tuning) : Less than 1.0 dB

All stated specifications are approximate and subject to change without notice or obligation.

SECTION 2 DISASSEMBLY INSTRUCTIONS

2-1 REMOVING THE PA BLOCK

1. Remove 19 screws (black, 8 mm) as shown in Fig. 1, to remove top and bottom covers.
2. Remove 3 screws (A), 4 screws (B) and 2 screws (C) as shown in Fig. 2.
3. Unplug 1 coaxial cable (J11), 4 connectors (J6, J13, J32 and J34) from the MAIN unit as shown in Fig. 6 (p. 2-3).
4. Unplug 1 coaxial cable (J20) from the CTRL unit as shown in Fig. 6 (p. 2-3).

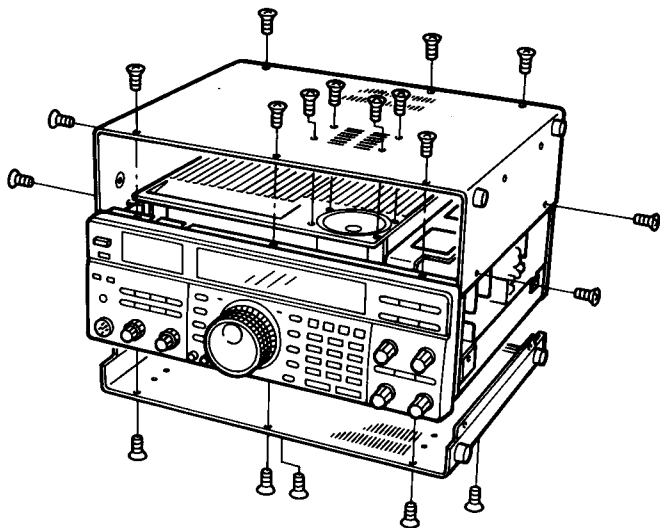

Fig. 1

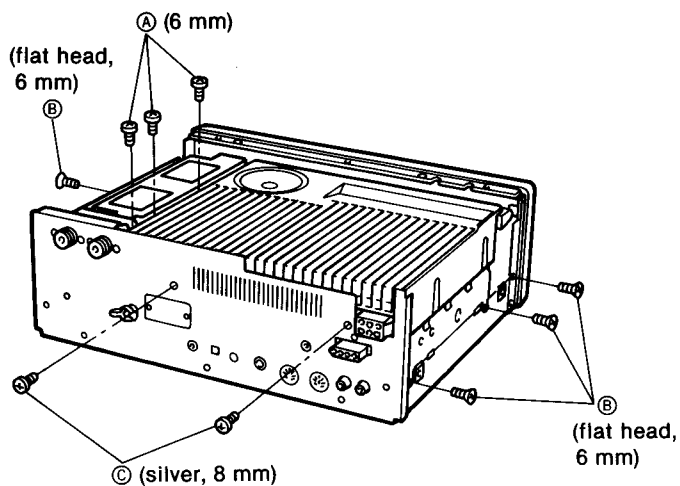
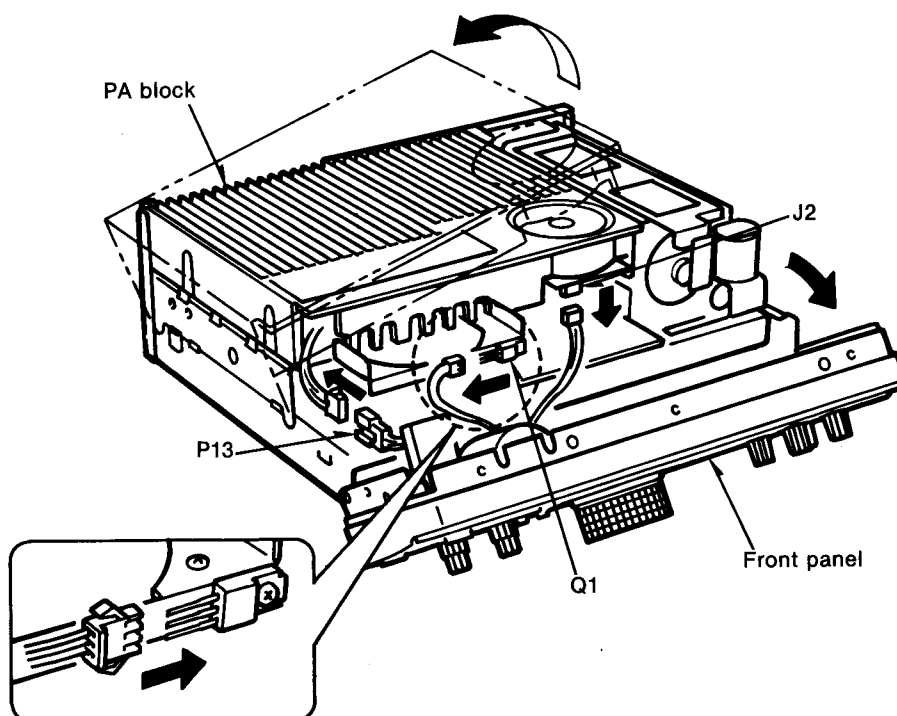

Fig. 2

5. Pull the front panel forward.
6. Unplug 3 connectors (6-pin connector from P13, 3-pin connector from Q1 and 4-pin connector from J2) as shown in Fig. 3.
7. Remove the PA block as shown in Fig. 3.



Pay attention to connector orientation when reconnecting to Q1.

Fig. 3

2-2 REMOVING THE ANTENNA TUNER

1. Remove 3 screws ④ and 6 screws ⑤ as shown in Fig. 4.
2. Unplug 1 coaxial cable (J19) and 4 connectors (J7, J15, J16 and J17) from the CTRL unit as shown in Fig. 6. (p. 2-3).

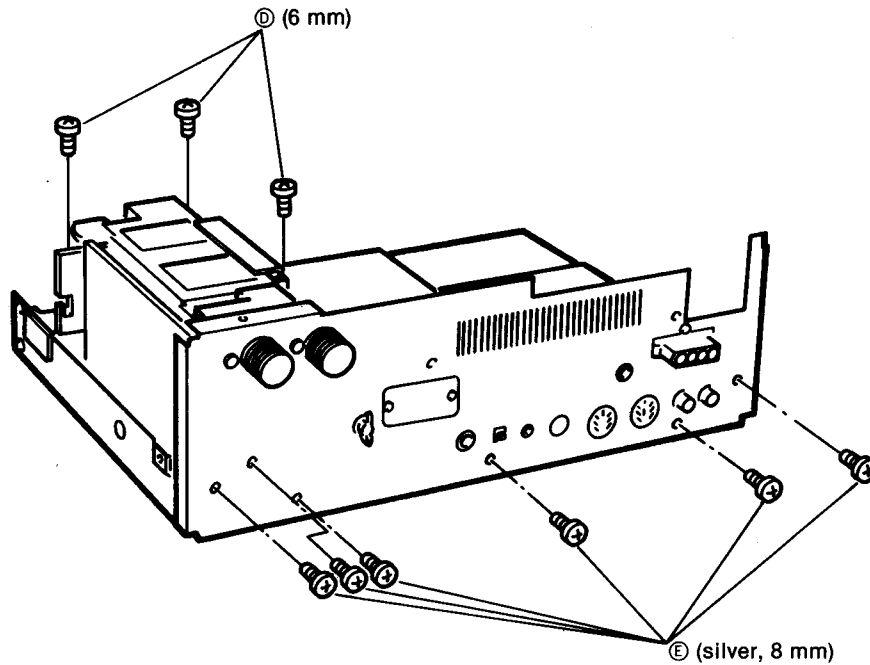

Fig. 4

3. Shift the rear panel backward and remove the antenna tuner as shown in Fig. 5.

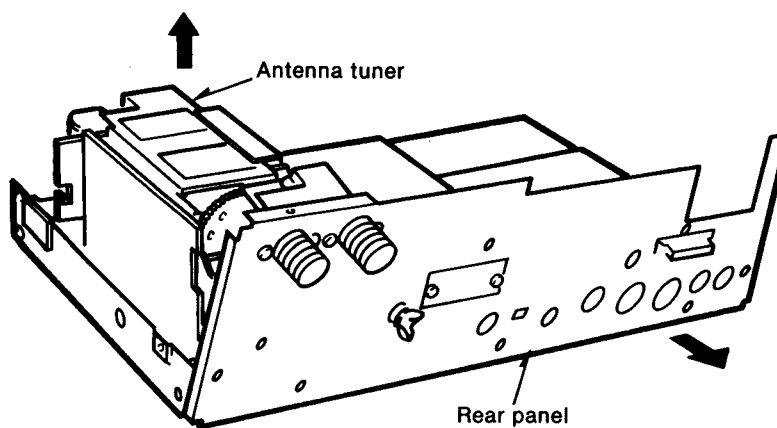

Fig. 5

2-3 CONNECTOR LOCATIONS

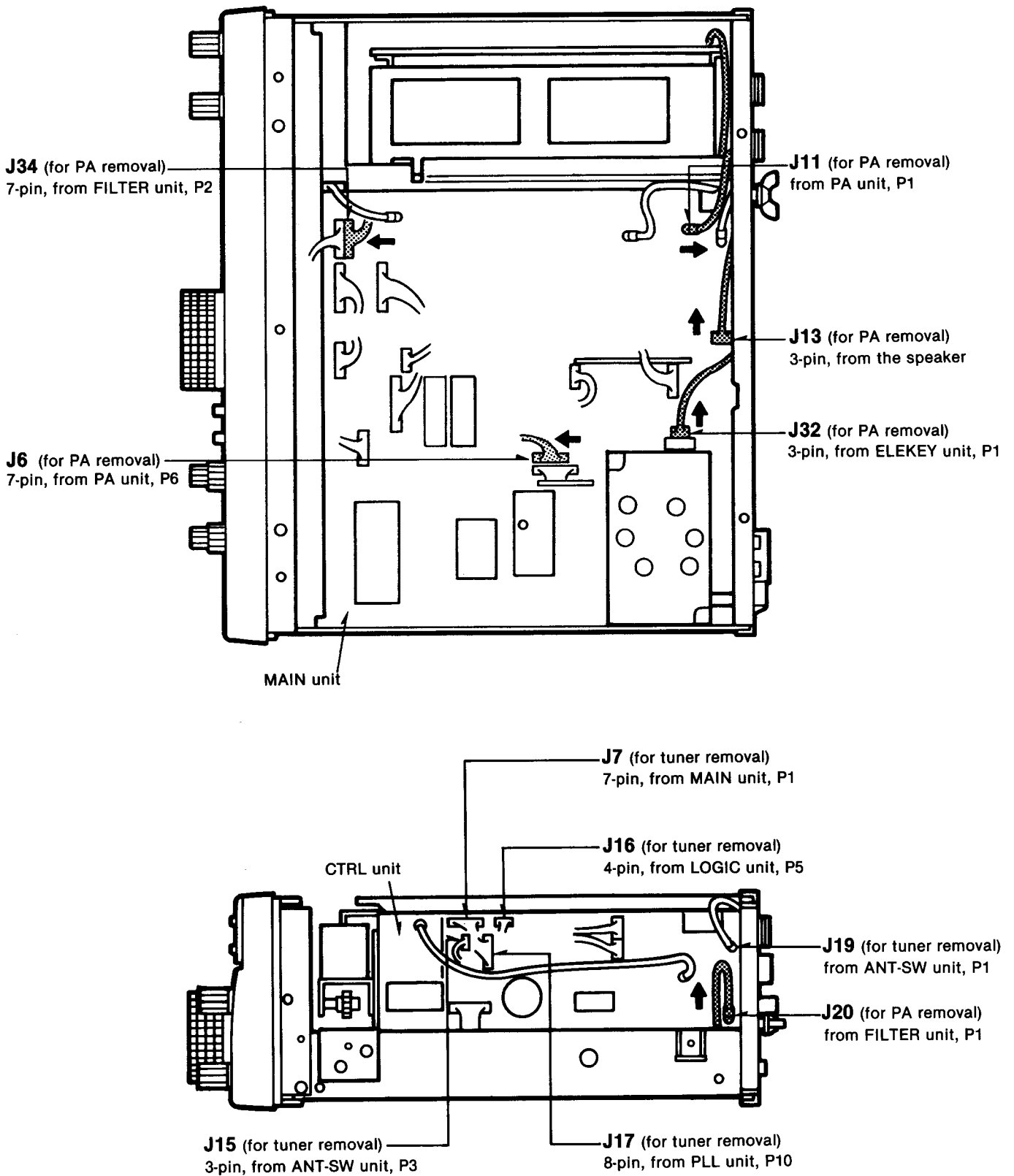
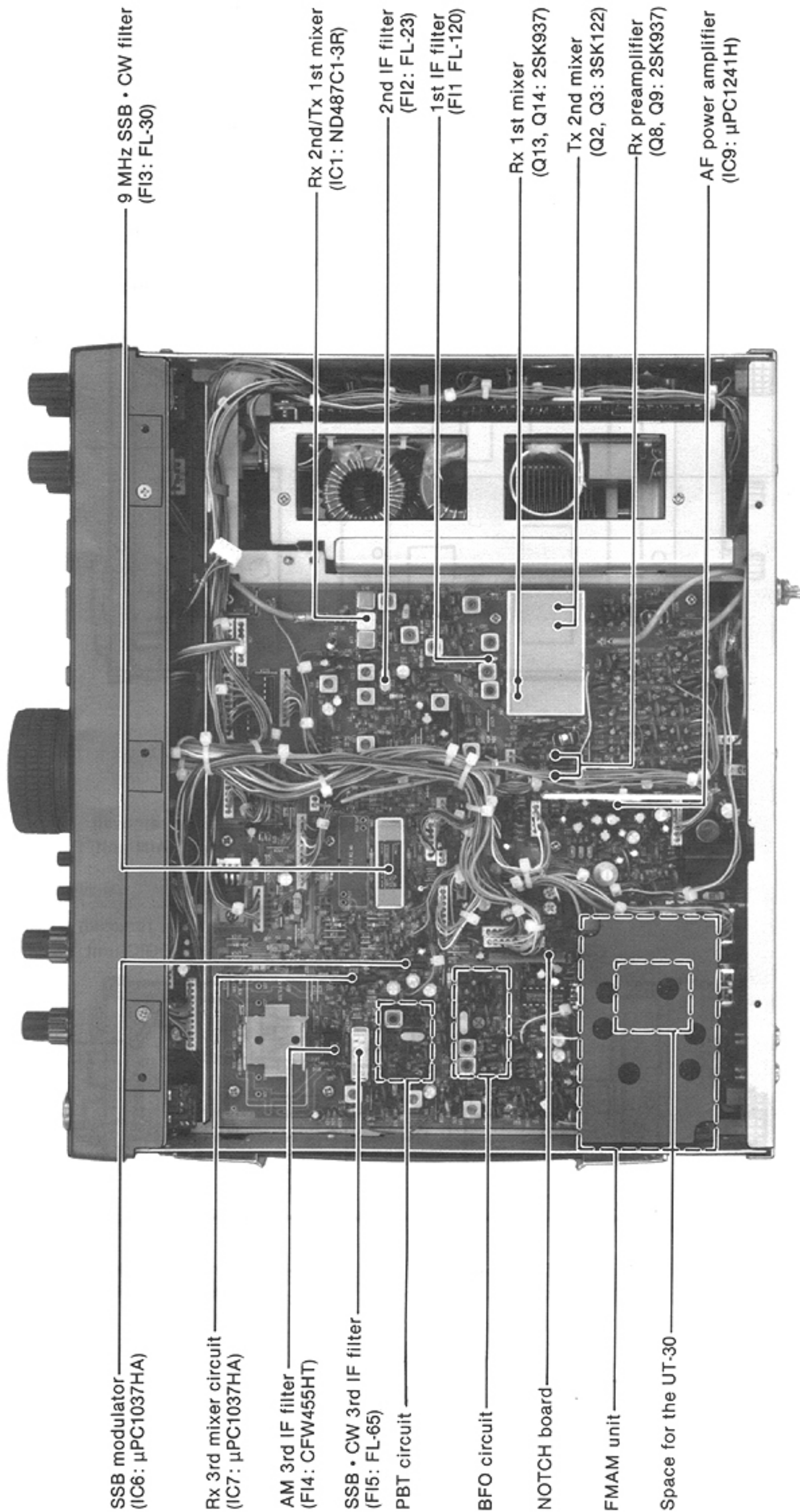

Fig. 6

SECTION 3 INSIDE VIEWS

• MAIN UNIT



- SSB modulator (IC6: μ PC1037HA)
- Rx 3rd mixer circuit (IC7: μ PC1037HA)
- AM 3rd IF filter (FI4: CFW455HT)
- SSB • CW 3rd IF filter (FI5: FL-65)
- PBT circuit
- BFO circuit
- NOTCH board
- FMAM unit
- Space for the UT-30
- 9 MHz SSB • CW filter (FI3: FL-30)
- Rx 2nd/Tx 1st mixer (IC1: ND487C1-3R)
- 2nd IF filter (FI2: FL-23)
- 1st IF filter (FI1: FL-120)
- Rx 1st mixer (Q13, Q14: 2SK937)
- Tx 2nd mixer (Q2, Q3: 3SK122)
- Rx preamplifier (Q8, Q9: 2SK937)
- AF power amplifier (IC9: μ PC1241H)

• PLL AND LOGIC UNITS

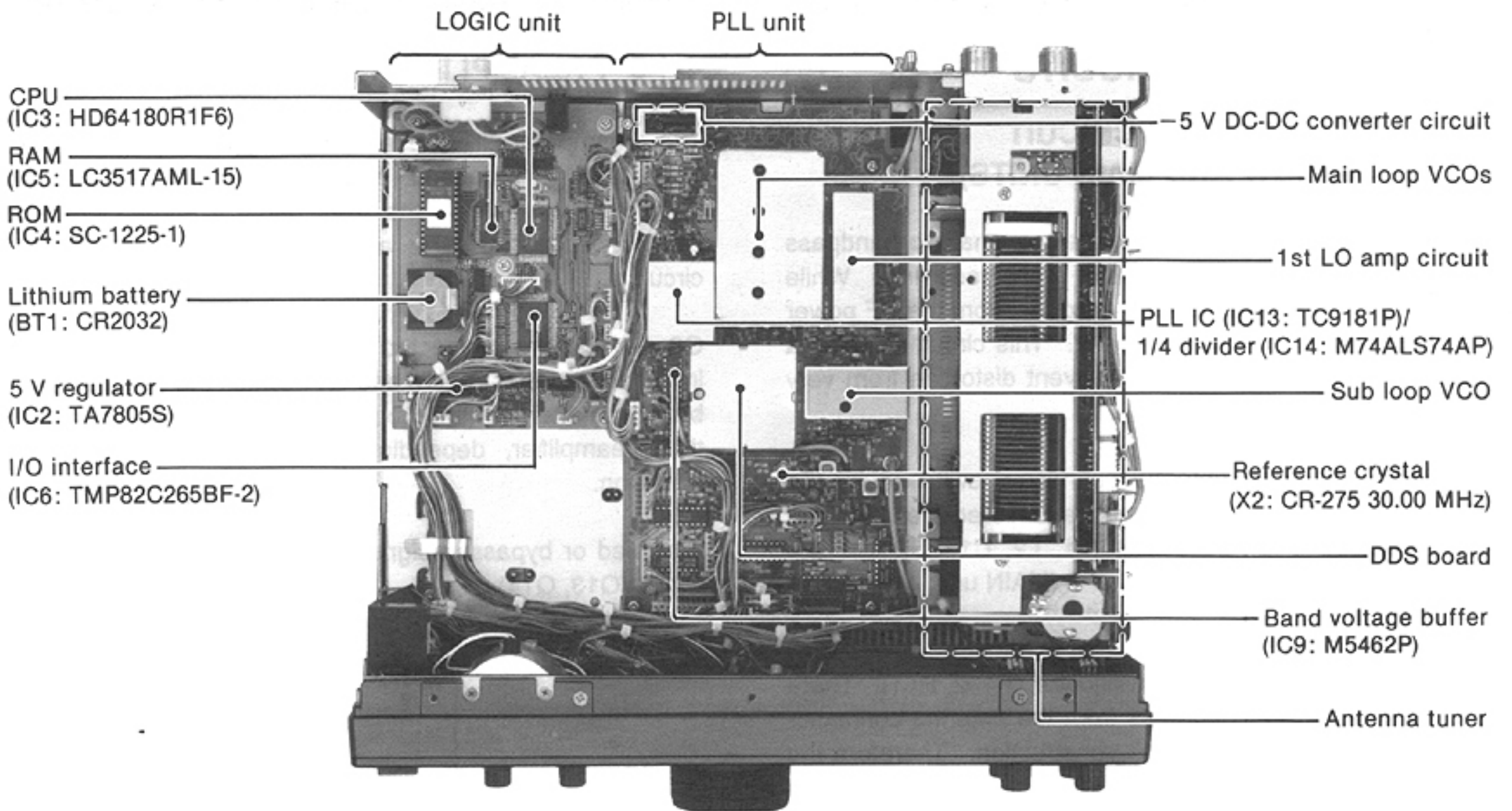

• PA, FILTER AND ELEKEY UNITS

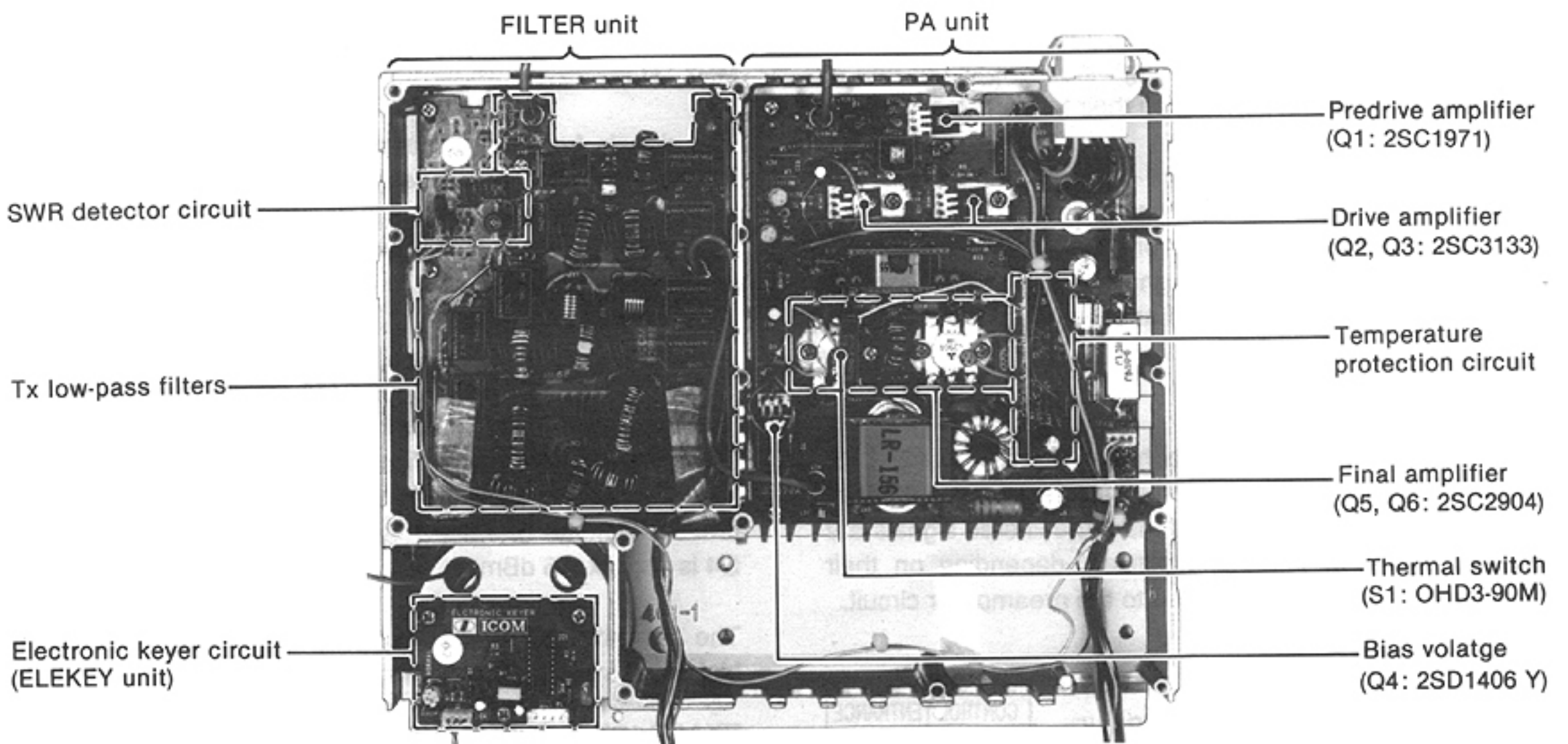

SECTION 4 CIRCUIT DESCRIPTION

4-1 RECEIVER CIRCUITS

4-1-1 RF SWITCHING CIRCUIT (ANT-SW AND MAIN UNITS)

The RF switching circuit leads receive signals to bandpass filters from an antenna connector while receiving. While transmitting, this circuit leads the signals from the RF power amplifier to the antenna connector. This circuit includes a 20 dB RF attenuator circuit to prevent distortion from very strong signals.

RF signals from an antenna connector, switched by the [ANT] switch, pass through the transmit/receive switching relay (RL1) and low-pass filter (L1, L2, C1-C5), and are then applied to the MAIN unit via P2 (MAIN unit: J12).

The signals from the ANT-SW unit are either bypassed or are attenuated at the 20 dB attenuator (R102, RL1). There are no non-linear components from the antenna connector to the attenuator in this circuit construction. Therefore the attenuator effectively prevents distortion caused by strong signals. The signals are then applied to RF filters.

4-1-2 RF BANDPASS FILTER CIRCUIT (MAIN UNIT)

RF bandpass filters pass only the desired band signals and suppress any undesired band signals.

The RF circuit has 7 RF bandpass filters (BPF) for signals above 1.6 MHz and 1 low-pass filter (LPF) for signals below 1.6 MHz. The signals pass through the low-pass or one of the bandpass filters depending on their frequencies.

(1) 0.5–1.6 MHz

There is no diode at the low-pass filter (L38, L39, C148-C150) entrance so as to prevent distortion from very strong signals. The filtered signals bypass a preamplifier through a bypass switch (Q12) and are then applied to the 1st mixer circuit (Q13, Q14).

(2) 1.6–30.0 MHz

These signals pass through a high-pass filter (L42, L43, C143-C146) to suppress strong signals below 1.6 MHz, such as from broadcasting stations. The filtered signals are applied to one of 7 bandpass filters depending on their frequencies and are then applied to the preamplifier circuit.

USED RF FILTER

BAND	CONTROL SIGNAL	ENTRANCE DIODE	BAND	CONTROL SIGNAL	ENTRANCE DIODE
0.5–1.6 MHz	B0	—	8–11 MHz	B4	D44
1.6–2 MHz	B1	D38	11–15 MHz	B5	D46
2–4 MHz	B2	D40	15–22 MHz	B6	D48
4–8 MHz	B3	D42	22–30 MHz	B7	D50

4-1-3 PREAMPLIFIER CIRCUIT (MAIN UNIT)

The preamplifier circuit uses two 2SK937s to obtain 10 dB gain over a wideband frequency range. When the [PRE AMP] switch on the front panel is turned ON, the signals above 1.6 MHz are applied to the preamplifier circuit.

Q8 and Q9 are connected in parallel to easily match the impedance to 50 Ω. Q10 and Q11 switch the signals from a bandpass filter, either to be bypassed, or to be applied to the preamplifier, depending on the [PRE AMP] switch condition.

Amplified or bypassed signals are applied to the 1st mixer circuit (Q13, Q14).

PREAMP CIRCUIT

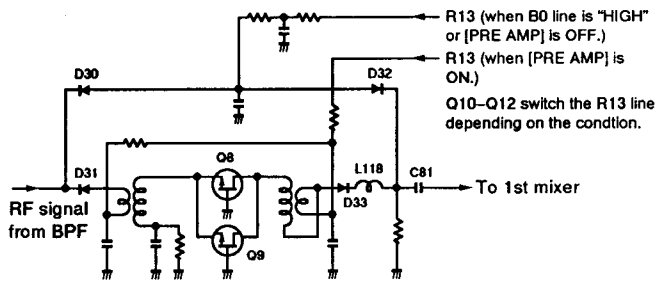

4-1-4 1ST MIXER CIRCUIT (MAIN UNIT)

The 1st mixer circuit mixes the receive signals with the 1st LO signal to convert the receive signal frequencies to a 69 MHz 1st IF.

The signals from the preamplifier circuit, or signals which bypass the preamplifier, pass through a low-pass filter. This low-pass filter suppresses signals above 30 MHz to eliminate direct receiving of signals at 69 MHz and image interference at 140 MHz. The signals are then applied to the 1st mixer (Q13, Q14).

The 1st LO signal (69.0600–99.0115 MHz) enters the MAIN unit from the PLL unit via J5. The LO signal is amplified at Q4, filtered by a low-pass filter, and then, applied to the 1st mixer. The low-pass filter uses a ring core inductor to prevent leakage of 1st LO signals. The output level from Q4 is approx. 15 dBm.

The 1st mixer (Q13, Q14) uses two 2SK937s to produce high level mixing with a high intercept point.

EXACT 1ST IF FREQUENCY

MODE	FREQUENCY (MHz)
SSB	69.0115
CW	69.0106
AM, FM	69.0100

4-1-5 1ST IF CIRCUIT (MAIN UNIT)

The 1st IF circuit filters and amplifies the 1st IF signals. The 1st IF signals from the 1st mixer circuit are applied to MCF (Monolithic Crystal Filter; FI1) to suppress out-of-band signals. The filtered signals are applied to the 1st IF amplifier (Q15). AGC voltage is supplied to the 2nd gate of Q15.

4-1-6 2ND MIXER CIRCUIT (MAIN UNIT)

The 2nd mixer circuit mixes the amplified 1st IF signals and 2nd LO signal (60.00 MHz) to convert the 1st IF to a 2nd IF.

The amplified 1st IF signals from Q15 are converted to 9 MHz 2nd IF signals at the 2nd mixer (IC1). IC1 is a DBM (Double Balanced Mixer). The DBM uses a coil with a glass-type core to treat the LO signal at a 0 dBm level.

The 2nd IF signals are applied to FI2 to suppress undesired signals such as the 2nd LO signal, and are then applied to the noise blanker gate (D5-D8).

EXACT 2ND IF FREQUENCY

MODE	FREQUENCY (MHZ)
SSB	9.0115
CW	9.0106
AM, FM	9.0100

4-1-7 NOISE BLANKER CIRCUIT (MAIN UNIT)

The noise blanker circuit detects pulse type noise, and turns OFF the signal line when noise appears.

The 2nd IF signals from FI2 are applied to the noise blanker gate (D5-D8). A portion of the signals from FI2 are amplified at the noise amplifiers (Q16, IC2, Q74), then detected at the noise detector (D12, D13). The detected signal from the noise detector is applied to the noise blanker switch (Q19).

NOISE BLANKER CIRCUIT

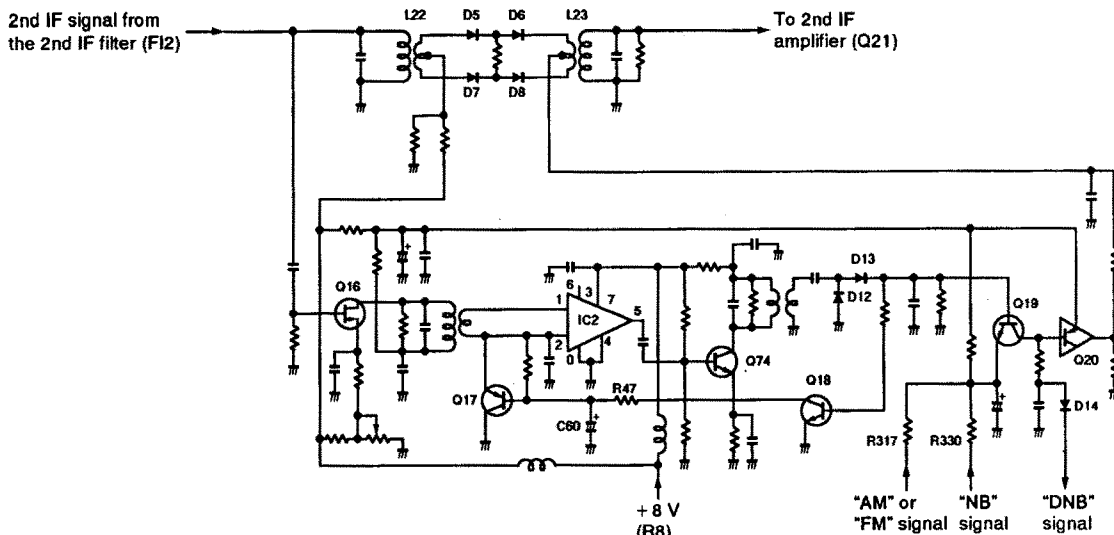

A portion of the detected signal from the noise detector is applied to the noise AGC circuit (Q17, Q18, C60, R43, R47) to control the bias voltage of the noise amplifier (IC2 pins 1, 2).

The threshold level of the noise blanker switch (Q19) is set at 0.9 V. When the detected voltage exceeds the threshold level, Q20 outputs a blanking signal to close the noise blanker gate (D5-D8), depending on the pulse noise period.

When the operating frequency is changed, the "DNB" signal line becomes "LOW," turning Q20 ON through D14. In this case, the noise blanker gate prevents PLL click noise.

4-1-8 2ND IF CIRCUIT (MAIN UNIT)

The 2nd IF circuit amplifies and filters the 2nd IF signals.

The signals passed through the noise gate (D5-D8) are amplified at Q21. The Loose tuning circuit (L24, C47) matches the signals to the 2nd IF filters.

When SSB or CW mode is selected, the signals pass through FI3 (FL-30). When an optional CW narrow filter is installed and CW-N mode is selected, the signals pass through the CW narrow filter. When AM mode is selected, the signals bypass the 2nd IF filter. When FM mode is selected, the signals are applied to the FMAM unit via the FIF signal line.

The filters are selected with mode selecting signals (SSB-CW, AM, CW-N) and the "T8" voltage line.

Signals from the filters are applied to the 3rd mixer (IC7) through D63.

4-1-9 3RD MIXER AND 3RD IF CIRCUITS (MAIN UNIT)

The 3rd mixer circuit mixes the filtered 2nd IF signals and the 3rd LO signal to convert the 2nd IF to a 3rd IF.

The 2nd IF signals from D63 are converted to a 455 kHz 3rd IF signal at the 3rd mixer (IC7). The 3rd IF signal is applied to FI4 (for AM mode) or FI5 (for SSB and CW mode). The filters are selected by the mode selecting signals. The filtered signal is amplified at Q27, Q28 and Q29 to obtain a detectable level.

A rapid time constant of AGC is used for Q27 to prevent rising edge distortion of receive signals. A thermistor (R419), connected to the gate of Q28, improves the temperature characteristics of the receiver gain. R138 adjusts the receiver gain. Q76 mutes the IF signal from Q28 until the R8 voltage line becomes 8 V DC. This prevents unwanted signal reception, especially during CW full break-in operation.

Output signals from Q28 are applied to the SSB/CW detector. Output signals from Q29 are shared between the AM detector and AGC detector.

4-1-10 BFO CIRCUIT (MAIN UNIT)

A 9 MHz signal oscillated at the BFO circuit (Q31, X1) is buffer-amplified at Q42 and applied to the balanced modulator (IC6) for transmission, and to a product detector (IC5) after mixing with the 3rd LO signal at IC12 for receive demodulation.

In USB mode, the "USB" signal line becomes "HIGH," turning D69 ON. The frequency is then adjusted with C294 to set the USB carrier point.

During CW transmission, the "CW" signal line becomes "HIGH," turning D68 ON. The frequency is then adjusted with L83 to set the CW transmit carrier point.

In LSB mode, the "LSB" signal line becomes "HIGH," turning D67 ON. The frequency is then adjusted with L82 to set the LSB carrier point.

During CW reception, R8 voltage turns Q33 ON, then switching diodes (D67–D69) are turned OFF. The frequency is fixed by coils (L81–L83) and capacitors (C294, C230).

BFO FREQUENCY IN EACH MODE

MODE	FREQUENCY (MHz)
USB	9.0130
CW (Tx)	9.0106
LSB	9.0100
CW (Rx)	9.0098
AM, FM	NO OUTPUT

4-1-11 PBT CIRCUIT (MAIN UNIT)

The PBT (PassBand Tuning) circuit shifts the 3rd IF within ± 1.5 kHz. As a result, the 3rd IF is shifted from the center frequency of the 3rd IF filter (FI5). This means the 3rd IF signal does not pass through the center of the 3rd IF filter because the passband width is fixed in the 2nd IF filter. Therefore, the overlap of the 2nd and 3rd IF filters appears to be narrowed.

Since the BFO frequency is also shifted the same value as the 3rd IF shift, frequency is corrected at the detector.

The 3rd LO signal to IC7 is produced by Q57 and X2. In SSB mode, the signal is shifted within ± 1.5 kHz by D101 variable voltage which is controlled by the [PBT] control. Therefore, the 3rd LO signal is shifted to activate the PBT.

In AM mode, D101 variable voltage is replaced with a preset voltage by Q62 and 9.4650 MHz is output regardless of the [PBT] control location.

In CW mode, D101 variable voltage is replaced with a preset voltage by Q60 and 9.4656 MHz is output regardless of the [PBT] control location.

PBT CIRCUIT

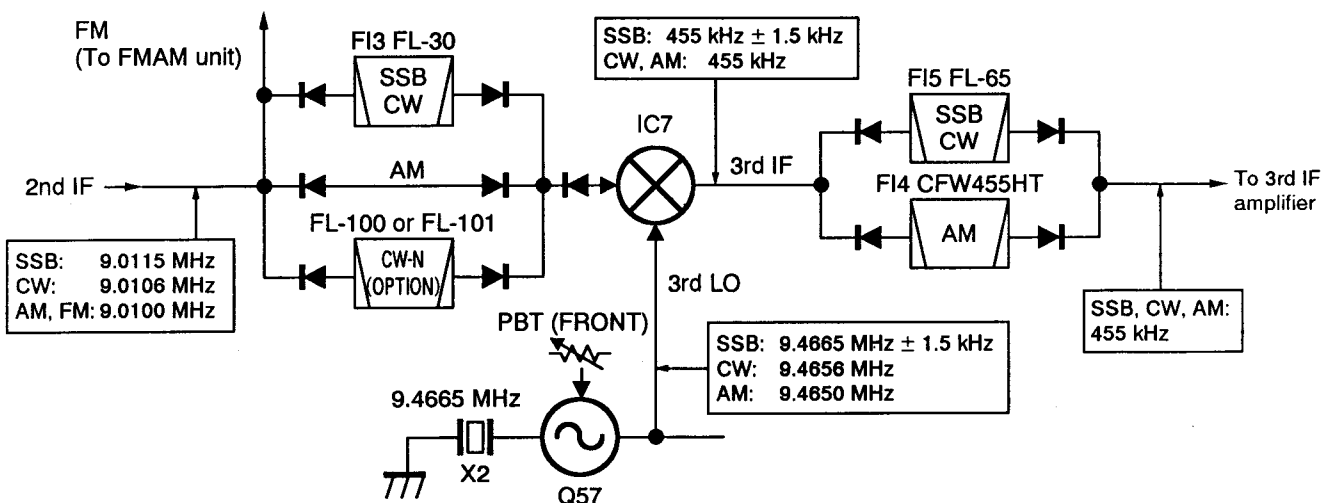

4-1-12 SSB/CW DEMODULATOR CIRCUITS (MAIN UNIT)

In SSB or CW mode, the 3rd IF signal from the IF amplifier (Q28) is mixed with the BFO signal from IC12 at the product detector (IC5) to demodulate the 3rd IF signal into an AF signal. The detected signal (AF) from IC5 (pin 3) is applied to the AF input mode selector switch (IC8).

4-1-13 AM DEMODULATOR CIRCUITS (MAIN UNIT)

In AM mode, the 3rd IF signal from the buffer amplifier (Q29) passes through C121 and is detected at D62. The detected signal (AF) is then applied to the AF input mode selector switch (IC8).

4-1-14 FM DEMODULATOR CIRCUIT (FMAM UNIT)

In FM mode, the 2nd IF signal, just before passing the 2nd IF filter, is applied to the FMAM unit via D52. The passed signal is applied to the FM IF IC where the IF signal is converted into the 3rd IF signal and is then converted into an AF signal.

X1 and X2 on the FMAM unit are used for the 3rd local oscillator and quadrature detector, respectively.

The detected signal (AF) is then applied to the AF input mode selector switch (IC8) on the MAIN unit.

4-1-15 AF INPUT MODE SELECTOR SWITCH (MAIN UNIT)

The AF signal from one of the detector circuits is applied to the AF input mode selector switch (IC8). IC8 consists of 4 analog switches which are selected with a mode signal and the squelch control signal. The AF signal is output from IC8 (pins 1, 4, 11) and then applied to the AF notch circuit.

4-1-16 AGC CIRCUIT (MAIN UNIT)

The AGC (Automatic Gain Control) circuit reduces IF amplifier gain to keep the audio output at a constant level.

The receiver gain is determined by the voltage on the AGC line (Q30, collector). The voltage is usually set by D58 and the resistance ratio of R121, R122, R315 and R316.

The 3rd IF signal from the buffer amplifier (Q29) is detected at the AGC detector (D59, D60) and is then applied to the DC amplifier (Q30). -5 V is applied to the Q30 emitter to activate the AGC line on the minus voltage.

When receiving strong signals, the detected voltage increases and the voltage of the AGC line decreases via the DC amplifier (Q30). As the AGC line is used for the bias voltage of the IF amplifiers (Q15, Q21, Q27), IF amplifier gain is decreased.

When the strong signal disappears, the AGC line voltage is released by C113 and R120 while fast AGC is set. When slow AGC is set, C112 and R119 are connected in parallel to obtain a slow AGC release time.

AGC CIRCUIT

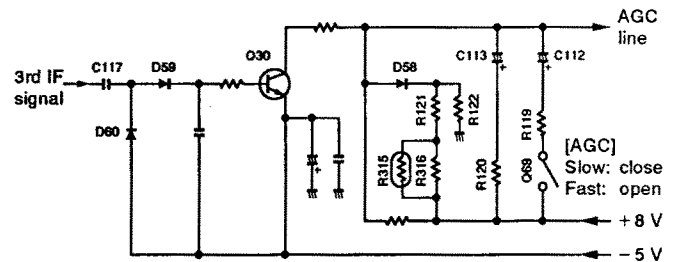

4-1-17 S-METER CIRCUIT (MAIN UNIT)

The S-meter circuit indicates the relative received signal strength while receiving by utilizing the AGC voltage which is changed depending on the received signal strength.

AF CIRCUIT

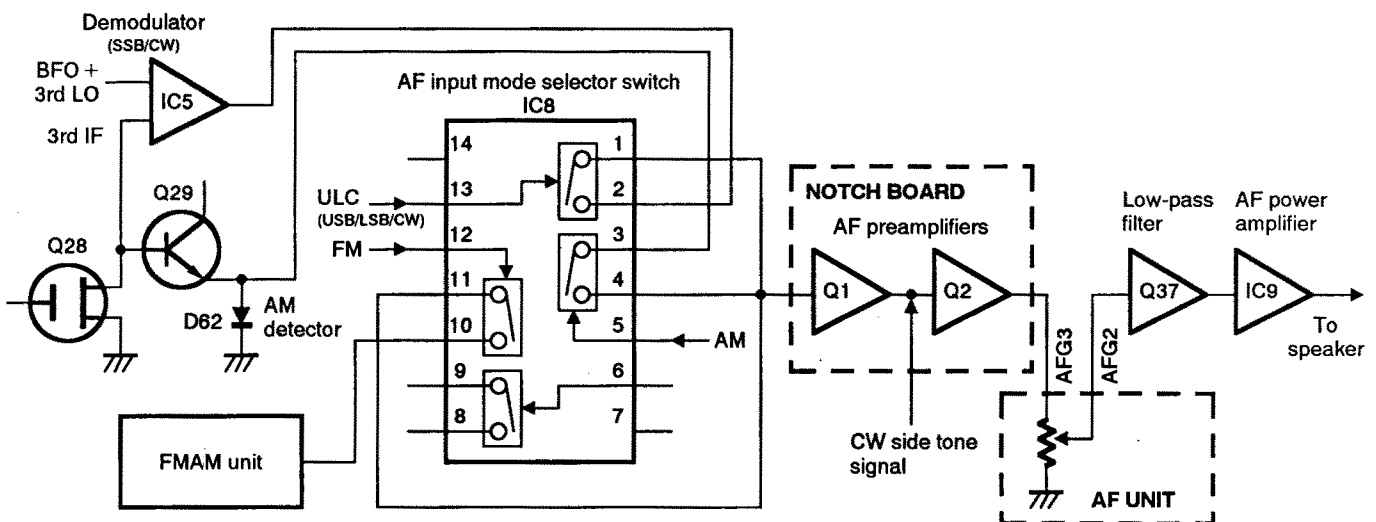

The AGC bias voltage (time constant line) is applied to a differential amplifier (IC4 pin 6) where the difference between the bias and reference voltages is detected.

The resulting S-meter signal passes through the meter switching circuit (IC8) and is then applied to the S/RF meter on the front panel. The reference voltage is adjusted with R116. IC8 (pins 8 and 9) are shorted inside the IC while receiving.

The FM S-meter signal from the FMAM unit is applied to the meter switching circuit (IC8 pin 9) via the "FSM" signal line. The signal is also applied to the squelch circuit (IC4 pin 2).

4-1-18 SQUELCH CIRCUIT (MAIN UNIT)

The squelch circuit mutes audio output when the S-meter signal is lower than the [SQL] control setting level.

The S-meter signal (SSB, CW, AM) from IC4 (pin 7) is applied to the comparator (IC4 pin 2) through D56 to be compared with the threshold level set by the [SQL] control.

In FM mode, the 3rd IF signal is amplified and detected at IC2 and D3/D4, respectively, in the FMAM unit. The detected signal (S-meter signal) is then applied to the comparator (IC4 pin 2).

When the S-meter signal is lower than the threshold level, the comparator becomes "HIGH" and Q32 turns OFF to deactivate the AF input mode selector switch (IC8 pins 5, 12, 13). This cuts AF output OFF. This signal is then applied to Q34, turning OFF the [RX] indicator, and is also applied to the [MICROPHONE] connector (pin 4) and [ACC(1)] connector (pin 6).

4-1-19 AF NOTCH CIRCUIT (NOTCH BOARD)

The notch circuit attenuates the specified audio frequency to increase intelligibility from desired signals.

The AF signal from the AF input mode selector switch (IC8) is applied to the AF notch circuit via an analog switch (IC2). IC2 and IC3 are analog switches which either select the AF signal to the notch circuit or bypass the notch circuit.

The signal is then applied to an active bandpass filter (IC1a), which has very narrow width characteristics, to pick up the interference frequency in reverse phase. The resulting signal is mixed with the original signal at R8 to obtain approx. 20 dB attenuation of the interference frequency components.

The center frequency can be adjusted with the [NOTCH] control. IC1b functions as a buffer amplifier.

4-1-20 AF AMPLIFIER CIRCUIT (NOTCH BOARD AND MAIN UNIT)

The AF amplifier amplifies the AF input signal to a suitable driving level for the speaker.

The AF signal from the AF notch circuit is applied to the AF preamplifiers (NOTCH board Q1, Q2). The CW side tone signal is applied to Q2.

The amplified signal is applied to the [AF] control (R1 on the AF unit) and then to the 2.8 kHz cut-off active low-pass filter (Q37). The AF signal output from Q37 is power-amplified at IC9 to drive the speaker.

4-2 TRANSMITTER CIRCUITS

4-2-1 MICROPHONE AMPLIFIER CIRCUIT (MIC AMP BOARD AND AF UNIT)

The microphone amplifier circuit amplifies the microphone input signals and outputs the amplified signal to the balanced modulator and FMAM unit. The speech compressor circuit is included in this circuit.

Audio signals from the [MICROPHONE] connector are amplified at Q1 (MIC AMP board) and then Q2 (AF unit). The amplified signals are then adjusted at the [MIC] control and amplified again at Q1 (AF unit). External modulation input from the [ACC(1)] socket (pin 4) is also applied to Q1 via R5 (AF unit). The microphone bias voltage is supplied from this circuit.

When the speech compressor is ON, the gain of Q2 increases and the diode limiter (AF unit D1, D2) is activated. The compression level is set by R17 (DISPLAY unit).

AF NOTCH CIRCUIT (NOTCH BOARD)

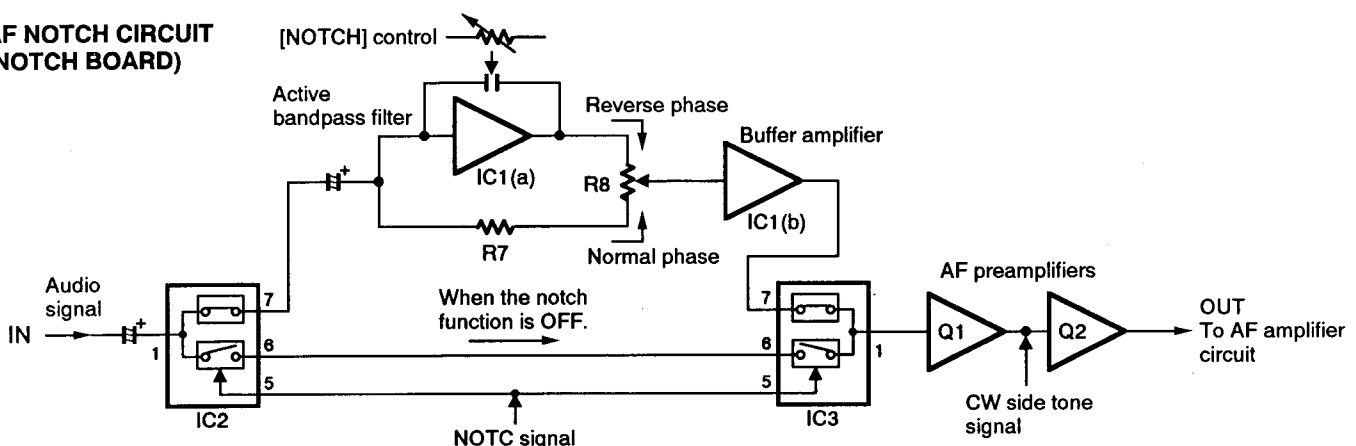

4-2-2 BALANCED MODULATOR (MAIN UNIT)

The balanced modulator converts the AF signal from the microphone amplifier to a 9 MHz IF signal with a BFO signal.

Output signals from the microphone amplifier and the CW keying signal are applied to the balanced modulator (IC6 pin 5). The BFO signal, buffer-amplified at Q42, is applied to IC6 (pin 7) as a carrier signal.

IC6 is a double balanced mixer IC and outputs a double side band (DSB) signal with – 40 dB carrier suppression.

R177 and R179 adjust the balanced level of IC6 for maximum carrier suppression. In CW mode, the CW keying signal upsets the balance to create a carrier signal.

4-2-3 FM AND AM MODULATION CIRCUITS (FMAM UNIT)

The microphone signals from the AF unit enter the FMAM unit via P2 (FMI2 line) and are then amplified at Q11 and the limiter amplifier/low-pass filter (IC5a/b).

In FM mode, the microphone signals are applied to the modulator circuit (D8) via R42. The modulation circuit changes the reactance of the FM local oscillator (Q1, X3) to obtain FM modulation. The modulated signal is amplified at IC3 and IC4 and is then applied to the transmitter IF circuit (MAIN unit Q22).

In AM mode, the microphone signals are applied to the local oscillator amplifier (IC4) via R44 as bias voltages to obtain AM modulation.

4-2-4 CW KEYING CIRCUIT (MAIN UNIT)

The CW keyer is connected to Q38. When the CW key is closed, 8 V is output from Q38 and this voltage controls break-in operation, the side tone signal and the transmit signal.

The 8 V from Q38 is applied via D93 to the balanced modulator (IC6) to unbalance the IC6 input bias voltage and create a carrier signal. R241 determines the transmit delay timing.

(1) BREAK-IN

When the [BK-IN] switch (S3 in the DISPLAY unit) is pushed IN, the IC-737 is automatically set to the transmission condition by CW keying. The 8 V from Q38 is applied to Q52 base via Q26. When the key is closed, Q52 grounds the SEND line for transmitting.

The transmit release delay time is determined by C252, R245 and the [DELAY] control (R244). When the [FULL] switch (S4 in the DISPLAY unit) is pushed IN, R425 is connected in parallel to obtain faster release time.

(2) SIDE TONE

When the CW key is closed, the side tone circuit (Q40) oscillates and sends the signal to the AF circuit.

Normally, D91 is ON, and C249 is connected to the Q40 collector so that no oscillation occurs. When the CW key is closed, the 8 V from Q38 via D92 give D91 reverse bias to disconnect C249 from Q40. Q40 then oscillates with 800 Hz as a side tone signal. R268 prevents side tone click noise.

(3) KEYING

Keying is controlled at 2 points in the IC-737. The balanced mixer (IC6) stops the carrier output by recovering the balance of the input bias voltage. D35, located at the 2nd IF mixer (IC1) input, cuts the signal line.

C251, R240 and R241 determine the voltage wave form to IC6 (pin 5) to make the keying wave form.

(4) ELECTRONIC KEYS (ELEKEY UNIT)

When a paddle is connected to the [KEY] jack and the [ELEKEY] switch (MAIN unit S2) is pushed IN, a "DOT" or "DASH" signal is applied to the electronic keyer IC (IC1).

The CW keying speed is adjusted with the [KEY SPEED] control (AF unit R2). The ratio of DOT:SPACE:DASH (keying weight) can be adjusted from 1:1:3 to 1.8:1:3.8 with R8.

IC1 outputs the keying signal in adjusted CW keying speed and weight, and the keying signal is then applied to Q38 in the MAIN unit.

4-2-5 IF AMPLIFIER (MAIN UNIT)

The SSB/CW 9 MHz IF signal passes through the FI3 (FL-30) to suppress the unwanted sideband signal, then the signal is applied to a transmit IF amplifier (Q22). The optional CW narrow filter is not used in transmitting.

The amplified signal from Q22 is mixed with the 2nd LO signal and converted to a 69 MHz IF signal at IC1. IC1 is used in receiving and transmitting. The FM/AM signal from the FMAM unit is also amplified at Q22 and is then applied to IC1.

The 69 MHz IF signal is amplified at the IF amplifier (Q7) and is then converted to the displayed frequency at the balanced mixer (Q2, Q3) with the 1st LO signal.

The gates of the IF amplifiers (Q7, Q22) are controlled by ALC bias voltage from the ALC circuit. A thermistor (R89), connected to the gate of Q22, improves the temperature characteristics of the transmitter gain. R85 adjusts the total transmitter gain.

4-2-6 RF CIRCUIT (MAIN AND PA UNITS)

The displayed frequency signal converted at the balanced mixer (Q2, Q3 in MAIN unit) is applied to the bandpass filter (L2, L3, C4-C7, C415) where unwanted LO signal emission is reduced. The filtered signal is amplified at Q1, and is then applied to the PA unit via the attenuator.

The signals from the MAIN unit are amplified at the predrive amplifier (Q1), drive amplifier (Q2, Q3) and power amplifier (Q5, Q6) in the PA unit to obtain a stable 100 W of RF output power.

The predrive amplifier is a class A amplifier with a Vcc of 13.8 V. The drive amplifier is a class AB push-pull amplifier with a Vcc of 13.8 V. D1 controls bias voltage to the drive amplifier.

The impedance of the signal from the drive amplifier is converted at L4, then the signal is applied to the power amplifier (Q5, Q6). The power amplifier is a class AB push-pull amplifier and amplifies the input signal to 100 W. D2 and D3 control bias voltage to the power amplifier. The signal from the power amplifier is applied to one of the low-pass filters.

4-2-7 LOW-PASS FILTER CIRCUIT (FILTER UNIT)

The low-pass filter circuit consists of 6 Chebyshev low-pass filters to suppress the higher harmonic components. The signal from the power amplifier (Q5, Q6) is applied to one of the low-pass filters (depending on its frequency). The filter switching voltage from the PLL unit (J7) passes through the MAIN unit and is applied to the FILTER unit via P2.

The filtered signal passes through the SWR detector circuit (L27) and is then applied to one of 2 antenna connectors via the antenna tuner circuit.

4-2-8 ALC CIRCUIT (MAIN UNIT)

The ALC (Automatic Level Control) circuit controls the gain of IF amplifiers in order for the IC-737 to output a constant RF power set by the [RF PWR] control even when the supplied voltage shifts, etc.

The RF power signal level is detected at D1 (FILTER unit) and applied to the MAIN unit as the "FOR" voltage.

The "FOR" voltage from the FILTER unit is applied to IC11 (pin 2) in the MAIN unit. The "POC" voltage, set by the [RF PWR] control (R16 on the DISPLAY unit), is applied to IC11 (pin 3) as the reference voltage.

When the "FOR" voltage exceeds the "POC" voltage, ALC bias voltage from IC11 (pin 1) controls the IF amplifiers (Q7, Q22). This adjusts the output power to the determined level by the [RF PWR] control until the "FOR" and "POC" voltages are equalized.

In AM mode, IC11 operates as an averaging ALC amplifier with C51 in the FMAM unit. Q54 turns ON and the "POC" voltage is shifted for 40 W AM output power (maximum) through R207.

The ALC bias voltage from IC11 (pin 1) is also applied to the inversion-amplifier (IC11 pin 6) to control the intensity of the [TX] indicator via R202 and D77, indicating the ALC level.

An external ALC input from the [ALC] jack is applied to the buffer amplifier (Q53). External ALC operation is identical to that of the internal ALC.

4-2-9 APC CIRCUIT (MAIN UNIT)

The APC (Automatic Power Control) circuit protects the power amplifiers on the PA unit from high SWR and excessive current.

The reflected wave signal appears and increases on the antenna connector when the antenna is mismatched. D2 of the SWR detector circuit (L27, D1, D2) in the FILTER unit detects the signal and applies it to Q56 in the MAIN unit as the "REF" signal.

ALC CIRCUIT

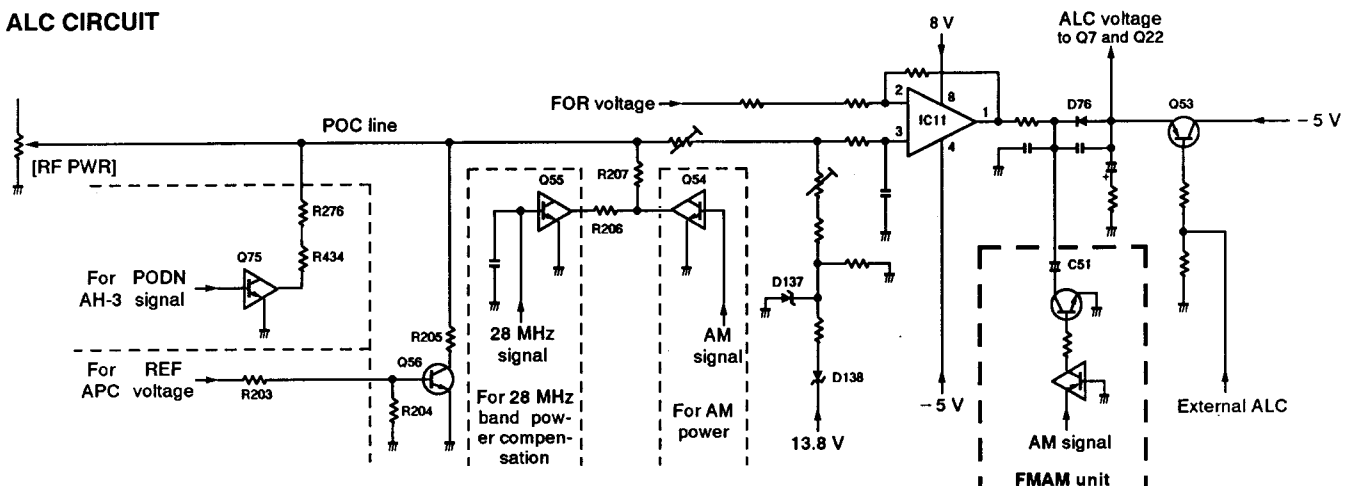

When the "REF" signal level increases, Q56 decreases the POC line voltage via R205. The POC line voltage is applied to IC11 to activate the ALC.

For the IC APC, the power transistor current is obtained by detecting the voltages ("ICH" and "ICL") which appear at both terminals of a 0.012 Ω resistor (R26 on the PA unit). The detected voltage is applied to the differential amplifier (IC10 pins 5, 6). When the current of the final transistors is more than 22 A, IC10 controls the ALC line via D73 to prevent excessive current flow.

Q55 is used for power reduction to prevent excessive current flow, when transmitting on the 28 MHz band, using the ALC line.

During tuning an antenna with an optional AH-3, the "PODN" signal turns Q75 ON. As a result, the "POC" voltage is shifted for 12 W output power.

4-2-10 TEMPERATURE PROTECTION CIRCUIT (PA UNIT)

A cooling fan (MF1) is activated while transmitting or if the temperature of Q5 or Q6 exceeds the preset value.

While transmitting, Q7 and Q8 are turned ON and provide a voltage to MF1 via R29. Thermistor R32 detects the temperature of Q5. If the Q5 temperature is more than 50°C (122 °F), R32 keeps turning Q7 and Q8 ON to rotate the cooling fan even when the transceiver condition has changed from transmitting to receiving.

FREQUENCY CONSTRUCTION

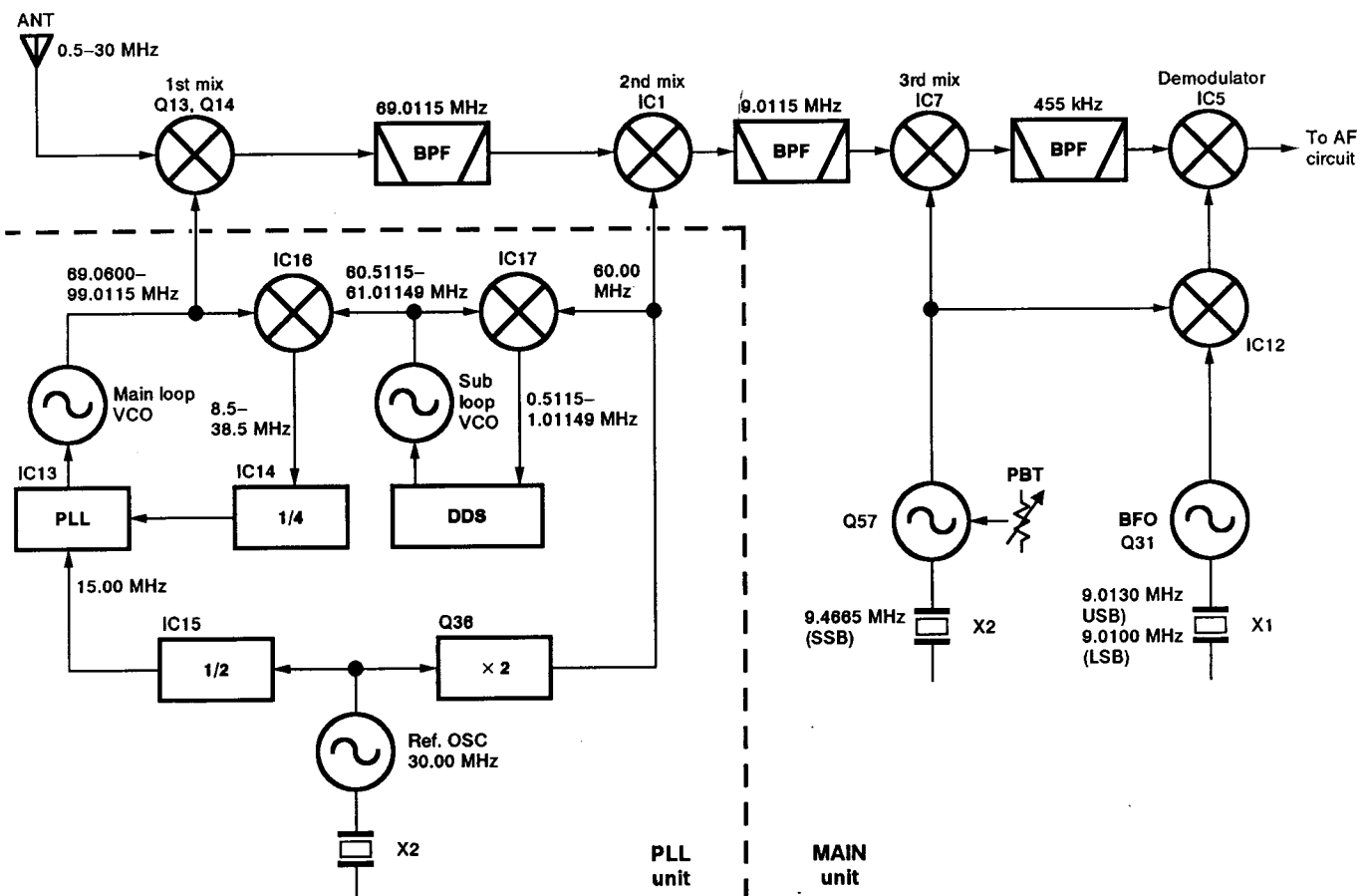

A thermal switch (S1) is thermally-connected to Q6. When the Q6 temperature exceeds 90°C (194 °F), S1 is turned ON and provides a voltage for high speed rotation to MF1 via R28.

4-2-11 RF METER CIRCUIT (MAIN UNIT)

The "FOR" voltage from the FILTER unit is applied to the Po meter amplifier (IC10 pin 3). The amplified voltage is output from IC10 (pin 1) and then applied to the meter. R186 adjusts the meter sensitivity and R189 and C261 are used for RF meter peak power hold.

4-3 PLL CIRCUITS

4-3-1 GENERAL DESCRIPTION

The PLL unit generates a 1st LO signal (69.0600-99.0115 MHz variable) and a 2nd LO signal (60.00 MHz fixed is used for the MAIN unit). The IC-737 uses a dual loop PLL system.

The main loop PLL contains 4 VCO circuits for all HF band coverage within 500 kHz steps. The sub loop PLL employs the DDS (Direct Digital Synthesizer) system which ensures a rapid lockup time and high quality frequency oscillation for 500 kHz coverage within 10 Hz steps.

4-3-2 1ST LO PLL CIRCUIT (PLL UNIT AND DDS BOARD)

The 1st LO circuit employs a dual loop PLL system. One of four VCO oscillation signals (main loop) is mixed with the signals from the sub loop PLL at IC16 and the resulting signal is divided by 4 at IC14 and then applied to the PLL IC (IC13). The signal is then divided by a programmable divider and compared with the reference frequency in IC13. The phase detected signal is converted to lock voltage at the active loop filter (Q12–Q14) and is then fed back to a VCO circuit to control the oscillation frequency.

In the sub loop PLL, the programmable dividing and phase detection are performed by digital processing in the DDS board. The sub loop, therefore, ensures that a high speed and a high quality signal can be generated. Meanwhile, the main loop PLL generates 500 kHz steps – this means high speed PLL can be accomplished – and 10 Hz steps are processed by the DDS. The quality of the dual loop PLL circuit is determined by the sub loop PLL.

4-3-3 MAIN LOOP CIRCUIT (PLL UNIT)

One of four VCO circuits is switched by the VCO switching signal (“VCO1”–“VCO4”). The oscillated signal is buffer-amplified at Q23 and Q46 and then applied to the mixer (IC16 pin 7). The sub loop PLL output signal is also applied to the mixer (IC16 pin 5).

The mixed signals are amplified at Q27 and then applied to the low-pass filter (L23–L25, C92, C93, C99–C103). The filtered signal is amplified at Q26 and then divided by 4 at IC14. Then the signal is applied to the PLL IC (IC13).

The signal is divided at the programmable divider section in IC13 and is then phase detected at the phase comparator section with the 125 kHz reference frequency. The phase detected signal is output from pin 17 and is then converted to a DC voltage (lock voltage) by the active loop filter (Q12–Q14). The lock voltage is applied to the varactor diodes (D48, D50, D52, D54) in the VCO circuits to change the capacitance of these diodes and control the oscillation frequency.

The VCO oscillating signal is then buffer-amplified at the buffer amplifiers (Q23, Q24) and is then applied to the MAIN unit as a 1st LO signal.

4-3-4 SUB LOOP CIRCUIT (PLL UNIT AND DDS BOARD)

The oscillated signal at the sub loop VCO (Q29, 60.5115–61.01149 MHz) is amplified at the buffer amplifier (Q30) and is then applied to the mixer (IC17 pin 5). The 60.00 MHz signal is also applied to this mixer (IC17 pin 7).

The mixed signal (0.5115–1.01149 MHz) passes through the low-pass filter (L32, C126) and is amplified at Q32. The signal is then applied to the DDS board.

The DDS board outputs pulse-type signals. The signals are applied to the loop filter (R133, R134, C114, C115, L42) to be converted to a DC voltage (lock voltage). The lock voltage is applied to the varactor diode (D56) to change the capacitance of this diode and control the sub loop VCO oscillation frequency.

4-3-5 REFERENCE OSCILLATOR CIRCUIT (PLL UNIT)

The reference oscillator circuit consists of Q33 and X2. 30.00 MHz reference frequency is oscillated to produce a 2nd LO signal and PLL reference frequency.

The reference frequency is buffer-amplified at Q34 and is then divided by 2 at IC15. The 15.00 MHz frequency is divided by 120 at the PLL IC (IC13) to obtain the 125 kHz PLL reference frequency.

The 30.00 MHz reference frequency is multiplied by 2 at Q36 to obtain the 2nd LO signal. The resulting 60.00 MHz signal is filtered at the bandpass filter and is then applied to a sub loop mixer (IC17) and to the MAIN unit via P4 as the 2nd LO signal.

4-4 LOGIC CIRCUITS

4-4-1 BAND SELECTION DATA (PLL UNIT)

To select the correct bandpass filter, low-pass filter and VCOs on the MAIN and PLL units, the CPU outputs the following band selection data from the I/O expander (IC23) depending on the displayed frequency.

BAND SELECTION DATA

FREQUENCY (MHz)	BPF	BAND VOLTAGE	LPF	VCO
0.5–1.59999	B0	7.4 V	L1	VCO1
1.6–1.99999	B1			
2.0–3.99999	B2	6.1 V	L2	
4.0–7.99999	B3	5.1 V	L3	
8.0–10.99999	B4	0.0 V	L4	VCO2
11.0–14.99999	B5	4.1 V		
15.0–21.99999	B6	3.2 V	L5	VCO3
22.0–29.99500	B7	2.2 V	L6	VCO4

4-4-2 RIT CONTROL (LOGIC UNIT)

The [RIT] control shifts a voltage to shift the receive frequency. The voltage is applied to IC8 (pin 4). IC8 is an A/D converter which outputs 8-bit serial data corresponding to analog input voltage. The resulting serial data is applied to the I/O interface (IC6) port PB00.

4-4-3 KEY MATRIX (SW, M-CH AND LOGIC UNITS)

	KS0 (PC00)	KS1 (PC01)	KS2 (PC02)	KS3 (PC03)	KS4 (PC04)	KS5 (PC05)
KR0 (PA10)	[TUNER]	[SSB]	[XFC]	[FREQ- INP]	[VFO/ MEMO]	[M → VFO]
KR1 (PA11)	[PRE AMP]	[CW/N]	[TS]	[SPLIT]	[MW]	[CLEAR]
KR2 (PA12)	[ATT]	[AM]	[A/B]	[A=B]	[SEL]	[SCAN]
KR3 (PA13)	[ANT]	[FM/TONE]	[1.8 [1]]	[3.5 [2]]	[7 [3]]	[M-CH UP]
KR4 (PA14)	[TUNE]	[MP-W]	[10 [4]]	[14 [5]]	[18 [6]]	[M-CH DN]
KR5 (PA15)	[AGC]	[MP-R]	[21 [7]]	[24.5 [8]]	[28 [9]]	[RIT]
KR6 (PA16)	[NB]	MIC U/D	[GENE [□]]	[29 [0]]	[ENT]	[ΔTX]
KR7 (PA17)	[COMP]	MIC CK	[LOCK]	[DOWN]	[UP]	[NOTCH]

4-4-4 CPU (LOGIC UNIT)

The CPU (IC3) contains an 8-bit CMOS CPU with a 12.288 MHz clock for rapid operation. The CPU controls the operating frequency, mode, function display, etc. The memory contents such as memory channel information are stored in the RAM IC chip (IC5) using a lithium backup battery which has a normal life of more than 5 years.

The Icom CI-V network system allows the IC-737 to be remotely controlled by a personal computer using an RS-232C I/O port.

4-4-5 I/O INTERFACE PORT ALLOCATIONS (LOGIC UNIT: IC6)

• INPUT PORTS

PORT NAME	PIN NUMBER	DESCRIPTION
KR0–KR7 (PA10– PA17)	23–19, 17–15	Input ports for return signals of the key matrix.
DIDN, DIUP (PC16, PC17)	29, 28	Input ports for up/down signal of the main dial.
DITS (PC15)	30	Input port for rapid rotation of the main dial.
DIQ1–DIQ5 (PC10– PC14)	32–35, 31	Input ports for 5-bit data of the main dial.
ADDT (PB00)	47	Input port for serial data of the [RIT] control.
IKEY (PB01)	48	Input port for the internal antenna tuner. This port becomes "LOW" while tuning.
EKEY (PB02)	49	Input port for the external antenna tuner (AH-3). This port becomes "LOW" when the antenna cannot be tuned.
CONNECT (PB03)	50	Input port for connection of the external antenna tuner. This port becomes "HIGH" when an external antenna tuner (AH-3) is connected.
SQLS (PB04)	52	Input port for the squelch signal. This port becomes "LOW" when the squelch is open.
TRC (PB05)	53	Input port for transmit/receive switching signal. This port becomes "HIGH" while transmitting.
CBUS (PB06)	55	Input port for busy signal of the CI-V bus line. This port becomes "HIGH" when the bus line is busy.

• OUTPUT PORTS

PORT NAME	PIN NUMBER	DESCRIPTION
STEN (PC07)	4	Outputs a strobe enable signal.
KS0–KS6 (PC00–PC06)	9–11, 13, 8, 7, 5	Output strobe signals for the key matrix and output expanders.
$\overline{\text{CRES}}$ (PB11)	37	Outputs a reset signal for the CI-V bus latch.
PODN (PB12)	38	Outputs a control signal for setting the tuning output power of the AH-3.
CSEN (PB13)	39	Outputs a control signal for tuning transmission.
$\overline{\text{ESTART}}$ (PB14)	40	Outputs a control signal for the external antenna tuner (AH-3).
$\overline{\text{ISTART}}$ (PB15)	42	Outputs a control signal for turning the internal antenna tuner ON.
$\overline{\text{ADCS}}$ (PB16)	43	Outputs an enable signal for the output expanders.
ADCK (PB17)	44	Outputs a clock signal for the output expanders.
NLDA (PA07)	71	Outputs a band signal for future use.
28M (PA06)	72	Outputs a 28 MHz band signal for the ALC circuit.
PLEN (PA05)	73	Outputs an enable signal for the PLL and DDS data.
DSTB (PA04)	74	Outputs a strobe signal for DDS.
PSTB (PA03)	75	Outputs a strobe signal for the main loop PLL.
$\overline{\text{INH}}$ (PA02)	76	Outputs an inhibit signal for the LCD drivers and output expanders.
LCE1, LCE2 (PA00, PA01)	78, 77	Output enable signals for the LCD drivers.

4-5 ANTENNA TUNER CIRCUITS

4-5-1 MATCHING CIRCUIT (TUNE UNIT)

The matching circuit is a T-network. Using 2 motors, the matching circuit obtains rapid overall tuning speed.

Using relays (RL1–RL6), the BPF selector signal (B2–B7) from the PLL unit grounds one of the taps of L1–L4. After selecting the coils, 2 motors (TUNER unit MF1, MF2) adjust C1 and C2 using the output of a motor control circuit to obtain a low SWR (Standing Wave Ratio).

4-5-2 DETECTOR CIRCUIT (CTRL UNIT)

The antenna tuner has 3 detector circuits: an SWR detector, a resistance component detector and a reactance component detector.

Forward and reflected power are picked up by L1, detected by D1 and D2, and then amplified at IC1a/b. The amplified voltages are applied to the SWR board. The SWR board outputs a signal according to the ratio of forward power to reflected power. The signal is compared with the reference voltage at IC6a to detect SWR exceeding 3:1.

Resistance components are picked up by L12 and detected by D8 and D9. D8 outputs negative voltage and D9 outputs positive voltage. Output voltage of the resistance component detector is added to the voltage output from D8 and D9. When antenna impedance is higher than 50 Ω , output voltage is negative; when lower than 50 Ω , positive.

Reactance components are picked up by comparing the phases of the RF current and RF voltage. The RF current is detected by L10 and R36. RF voltage is detected by C17–C19. Both detector voltages are buffer-amplified at Q1, Q2, Q25 and Q26, and are then applied to the phase comparator (IC3, IC5). The output signal of IC5 is detected at D6 and D7. When the RF current phase leads the voltage phase, the detected voltage is negative; when the current lags the voltage, the detected voltage is positive.

4-5-3 MOTOR CONTROL CIRCUIT (CTRL UNIT)

The antenna tuner CPU (IC10) controls the tuning motors and memorizes the best preset position on each band. The memory contents are stored in the CPU using a lithium backup battery which has a normal life of more than 5 years.

The output signal of the resistance detector is compared with a reference voltage (V_{REF}) at IC6 (pins 5 and 6), and applied to the A/D converter section (IC10, pin 19). The CPU outputs an RC1 or RC2 signal to the motor driver (IC9) to drive the motor (TUNER unit MF2) in the matching circuit. These signals become a pulse signal just around the preset position for precise and rapid tuning. To detect C2 rotation, voltage from the variable resistor (VR-E unit R1) is applied to the CPU.

The output signal of the reactance detector is compared with the reference voltage (V_{REF}) at IC6 (pins 12 and 13), and applied to the A/D converter section (IC10, pin 18). The CPU outputs a ϕ C1 or ϕ C2 signal to the motor driver (IC9) to drive the motor (TUNER unit MF1) in the matching circuit. To detect C1 rotation, a voltage from the variable resistor (VR-D unit R1) is applied to the CPU.

The reset circuit halts the CPU while the motor is not controlled. When the operating band is changed, the band signal comparator (IC13) outputs a "LOW" signal to a reset control circuit. The reset control circuit turns the CPU ON, setting C1 and C2 on the TUNE unit to their preset positions.

When the antenna tuner cannot tune from a previously memorized preset position, a re-try function is activated. The re-try function tunes C1 and C2 from end to end 3 times.

4-5-4 ANTENNA TUNER CPU PORT ALLOCATIONS

• INPUT PORTS

PORT NAME	PIN NUMBER	DESCRIPTION
ϕ PV	16	Input port for the detection of C1 position.
RPV	17	Input port for the detection of C2 position.
ϕ	18	Input port for the reactance detection voltage. This voltage becomes $V_{REF}/2$ when the antenna is matched.
R	19	Input port for the resistance detection voltage. This voltage becomes $V_{REF}/2$ when the antenna is matched.
WR	23	Input port for the WRITE mode signal.
SET	24	Input port for the SET signal.
PWRS	26	Detects the power voltage. When the signal is "LOW," the CPU is backed up.
B1-B3	29-27	These are input ports for the 3-bit band signal from the PLL unit.
SEND	30	Inputs transmit/receive switching signals. This port becomes "LOW" while transmitting.
SWR	31	Detects an SWR signal. When the SWR exceeds 3, this port becomes "HIGH."
TUNR	32	Detects a tuner switch signal. The signal is "HIGH" when the [TUNER] switch is turned ON.
RESET	34	Inputs a reset signal. This port becomes "HIGH" at the beginning of transmission or when the operating band is changed.

• OUTPUT PORTS

PORT NAME	PIN NUMBER	DESCRIPTION
WAIT	6	Outputs a control signal for the [TUNE] indicator. This port becomes "HIGH" while tuning or pre-setting. This port becomes "HIGH" and "LOW" alternately when the antenna tuner cannot tune the antenna with the re-try function.
b1-b3	10-8	These are output ports for the current 3-bit band signal of the antenna tuner.
ϕ C1, ϕ C2	12, 11	Output control signals for MF1.
RC1, RC2	14, 13	Output control signals for MF2.
V_{REF}	20	Outputs a reference voltage for the resistance and reactance detectors.
WAKE	25	Outputs a control signal for the reset circuit. This port becomes "HIGH" while the CPU clock is oscillated.
TUN	39	Outputs a tuner switch signal. The signal is "HIGH" when the TUNR port is "HIGH."

4-6 REGULATOR CIRCUITS

Either +8 V, +5 V or -5 V DC is supplied from a corresponding regulator circuit. +8 V, +5 V and -5 V DC are regulated at the following circuits using 13.8 V DC.

(1) +5 V REGULATOR (LOGIC UNIT)

+5 V DC is provided by a three-terminal voltage regulator (IC2).

(2) +8 V REGULATOR (MAIN UNIT)

+8 V DC is provided by a three-terminal voltage regulator (IC14).

(3) -5 V REGULATOR (PLL UNIT)

IC6 generates a negative pulse-type voltage by converting the DC input to AC voltages (approx. 6.7 kHz) as a multi-vibrator. The voltage is rectified at D8 and D9, regulated by a Zener diode (D10) and C12, and is then applied to the MAIN and CTRL units.

SECTION 5 ADJUSTMENT PROCEDURES

5-1 PREPARATION BEFORE SERVICING

■ REQUIRED TEST EQUIPMENT

EQUIPMENT	GRADE AND RANGE	EQUIPMENT	GRADE AND RANGE
DC power supply	Output voltage : 13.8 V DC	AC millivoltmeter	Measuring range : 10 mV–10 V
	Current capacity : 30 A or more	DC voltmeter	Input impedance : 50 kΩ/DC or better
RF power meter (terminated type)	Measuring range : 10–200 W	Ammeter	Measurement capability: 1 A and 30 A
	Frequency range : 1.8–30 MHz	Audio generator	Frequency range : 300–3000Hz
	Impedance : 50 Ω	Output level : 1–500 mV	
Frequency counter	SWR : Less than 1.2 : 1	Attenuator	Power attenuation : 50 or 60 dB
	Frequency range : 0.1–100 MHz	Capacity : 150 W or more	
RF voltmeter	Frequency accuracy: ± 1 ppm or better	Spectrum analyzer	Frequency range : At least 90 MHz
	Sensitivity : 100 mV or better	Spectrum bandwidth: ± 100 kHz or more	
Standard signal generator (SSG)	Frequency range : 0.1–100 MHz	FM deviation meter	Frequency range : At least 30 MHz
Distortion meter	Output level : 0.1 μV–32 mV	Measuring range : 0 to ± 10 kHz	
	(-127 to -17 dBm)	Modulation analyzer	Frequency range : At least 30 MHz
Oscilloscope	Frequency range : 1 kHz ± 10%	Measuring range : 0–100%	
	Measuring range : 1–100%	External speaker	Impedance : 8 Ω
		Max. input power : 5 W	
		Terminator	Resistance : 50 and 150 Ω
			Capacity : 150 W or more

CW: Clockwise CCW: Counterclockwise

■ CONNECTION

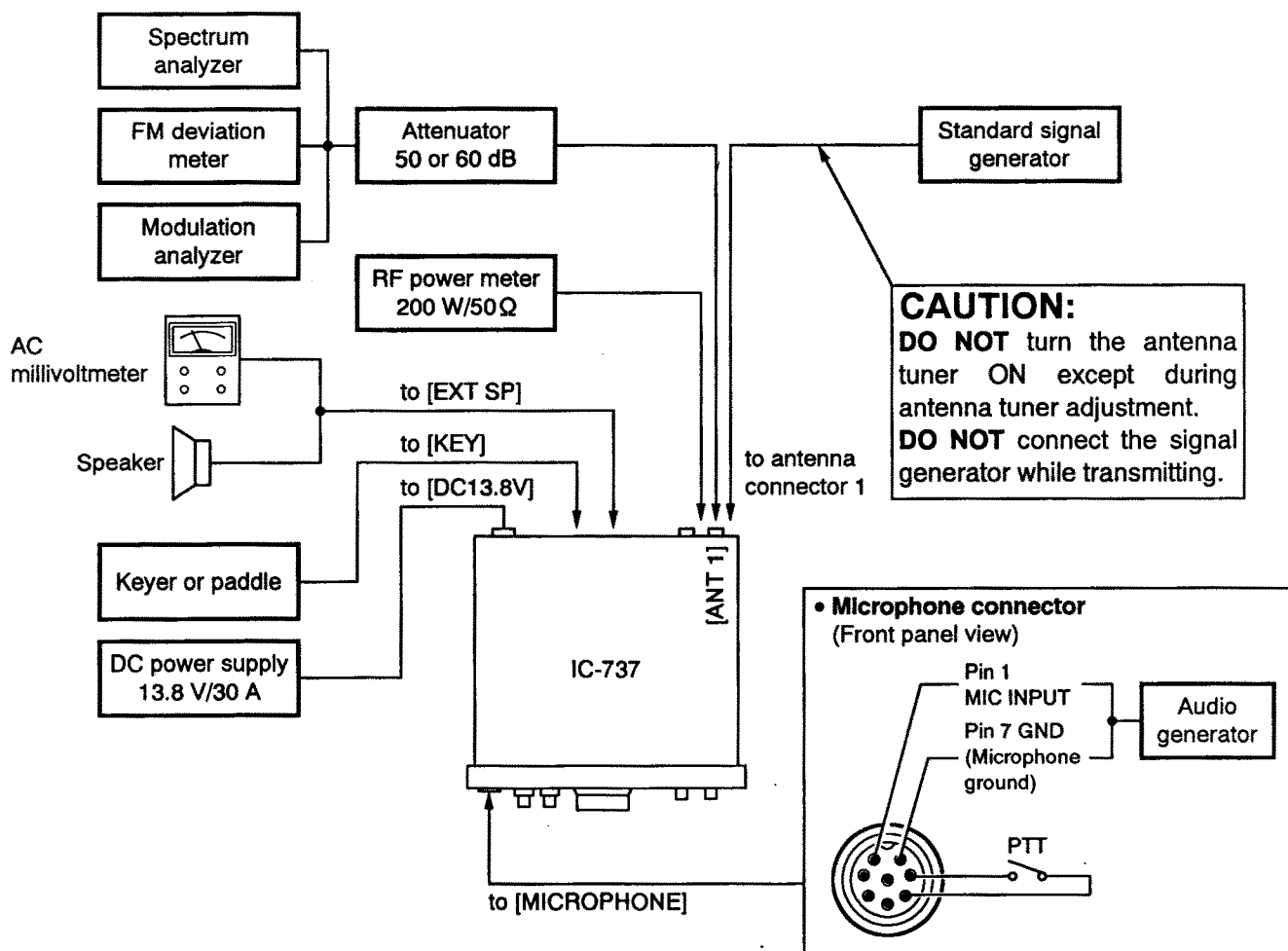

5-2 PLL ADJUSTMENT

ADJUSTMENT	ADJUSTMENT CONDITIONS	MEASUREMENT		VALUE	ADJUSTMENT POINT	
		UNIT	LOCATION		UNIT	ADJUST
DDS CLOCK	1 <ul style="list-style-type: none"> Displayed frequency: 14.10000 MHz Mode : USB Receiving 	DDS	Connect the frequency counter to IC4 (pin 11) or IC5 (pin 11).	5.24288 MHz	DDS	C1
REFERENCE FREQUENCY	1 <ul style="list-style-type: none"> Displayed frequency: 14.10000 MHz Mode : USB Terminate P4 with a 50 Ω resistor. Receiving 	PLL	Connect the RF voltmeter to P4.	Preset to center as shown below.	PLL	C134
						
			Maximum level (+1 dBm to +5 dBm)	L38, L39		
	2		Connect the frequency counter to P4.	60.0000 MHz	L35	
3		4 After adjustment, remove the resistor from P4 and re-plug P4.				
DDS LOOP	1 <ul style="list-style-type: none"> Displayed frequency: 14.00000 MHz Mode : USB Receiving 	PLL	Connect the digital multimeter or oscilloscope to R133.	1.0 V DC	PLL	C205
	2 <ul style="list-style-type: none"> Displayed frequency: 13.99999 MHz 			1.8–2.4 V DC		Verify
HPL LOCK VOLTAGE	1 <ul style="list-style-type: none"> Displayed frequency: 7.99999 MHz Mode : USB Receiving 	PLL	Connect the digital multimeter or oscilloscope to R77.	7.0 V DC	PLL	C35
	2 <ul style="list-style-type: none"> Displayed frequency: 14.99999 MHz 			7.0 V DC		C46
	3 <ul style="list-style-type: none"> Displayed frequency: 21.99999 MHz 			7.0 V DC		C59
	4 <ul style="list-style-type: none"> Displayed frequency: 30.00000 MHz 			7.0 V DC		C70
	5 <ul style="list-style-type: none"> Displayed frequencies: 0.50000 MHz, 8.00000 MHz, 15.00000 MHz and 22.00000 MHz 			More than 1.65 V DC		Verify
1st LO OUTPUT LEVEL	1 <ul style="list-style-type: none"> Displayed frequency: 14.10000 MHz Mode : USB Terminate P5 with a 50 Ω resistor. Receiving 	PLL	Connect the RF voltmeter to P5.	More than – 2 dBm	PLL	Verify
	2	After confirmation, remove the resistor from P5 and re-plug P5.				
RIT	1 <ul style="list-style-type: none"> Displayed frequency: 14.10000 MHz Mode : USB [RIT/ΔTX] control : Center [RIT] switch : ON Receiving 	Front panel	RIT/ Δ TX frequency readout	0.00 kHz	LOGIC	R19
	NOTE: If R19 cannot adjust the RIT/ Δ TX frequency readout to 0.00 kHz, move the [RIT/ Δ TX] knob to a neighboring thread.					

• PLL AND LOGIC UNITS AND DDS BOARD

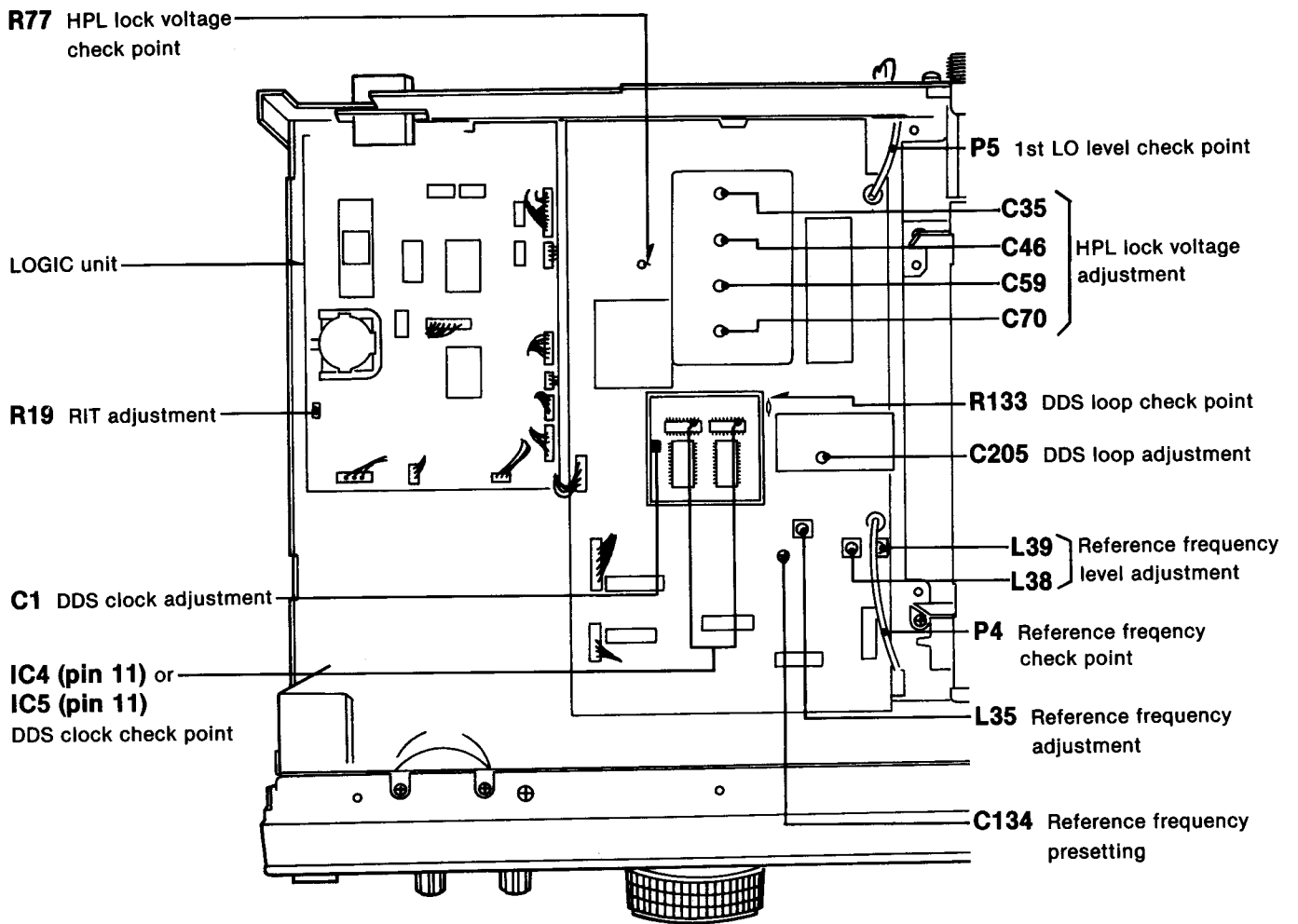

5-3 RECEIVER ADJUSTMENT

ADJUSTMENT	ADJUSTMENT CONDITIONS	MEASUREMENT		VALUE	ADJUSTMENT POINT					
		UNIT	LOCATION		UNIT	ADJUST				
BFO FREQUENCY	1	<ul style="list-style-type: none"> Displayed frequency: 14.10000 MHz Mode : USB Receiving 	MAIN	Connect the frequency counter to R184.	9.01300 MHz	MAIN	C294			
	2	<ul style="list-style-type: none"> Mode : CW Transmitting 					9.01060 MHz	L83		
	3	<ul style="list-style-type: none"> Mode : LSB Receiving 					9.01000 MHz	L82		
	4	<ul style="list-style-type: none"> Mode : CW Receiving 					9.00980 MHz (± 150 kHz)	Verify		
	5	<ul style="list-style-type: none"> Mode : AM Receiving 					No output			
PBT OSC	1	<ul style="list-style-type: none"> Displayed frequency: 14.10000 MHz Mode : USB [PBT] control : Center Receiving 	MAIN	Connect the frequency counter to R286.	9.46650 MHz	MAIN	L106			
	2	<ul style="list-style-type: none"> Mode : CW Receiving 					9.46560 MHz	R304		
	3	<ul style="list-style-type: none"> Mode : AM Receiving 					9.46500 MHz (± 500 kHz)	Verify		
	4	<ul style="list-style-type: none"> Mode : CW [PBT] control : Max. CW 					Higher than 9.46710 MHz			
	5	<ul style="list-style-type: none"> Mode : CW [PBT] control : Max. CCW 					Lower than 9.46410 MHz			
SENSITIVITY	1	<ul style="list-style-type: none"> Displayed frequency: 14.10000 MHz Mode : FM [PRE AMP] switch : ON [ATT] switch : OFF [ANT] switch : ANT 1 [TUNER] switch : OFF [AGC] switch : Fast (ON) [NB] switch : OFF [RIT] switch : OFF [SQL] control : Max. CCW 	MAIN	Connect the digital multimeter or oscilloscope to the cathode of D56.	Maximum voltage	MAIN	Adjust in sequence L33, L34, L35, L36, L22, L23			
	2	<ul style="list-style-type: none"> Connect the SSG to the [ANT 1] connector and set as: Frequency : 14.0985 MHz Level : 50 μV* (-73 dBm) Modulation : FM/1 kHz Deviation : ± 15 kHz R138 (MAIN) : Max. CCW Receiving 					Rear panel	Connect the distortion meter to the [EXT SP] jack with an 8 Ω load.	Minimum distortion level	L21
	3	<ul style="list-style-type: none"> Mode : AM Set the SSG as: Modulation : AM/1 kHz Deviation : ± 6 kHz R138 (MAIN) : Max. CW Receiving 					MAIN	Connect the digital multimeter or oscilloscope to the cathode of D56.	Maximum voltage	Adjust in sequence L79, L78, L77

* This output level of the standard signal generator (SSG) is indicated as SSG's open circuit.

• MAIN UNIT
(for BFO and PBT adjustment)

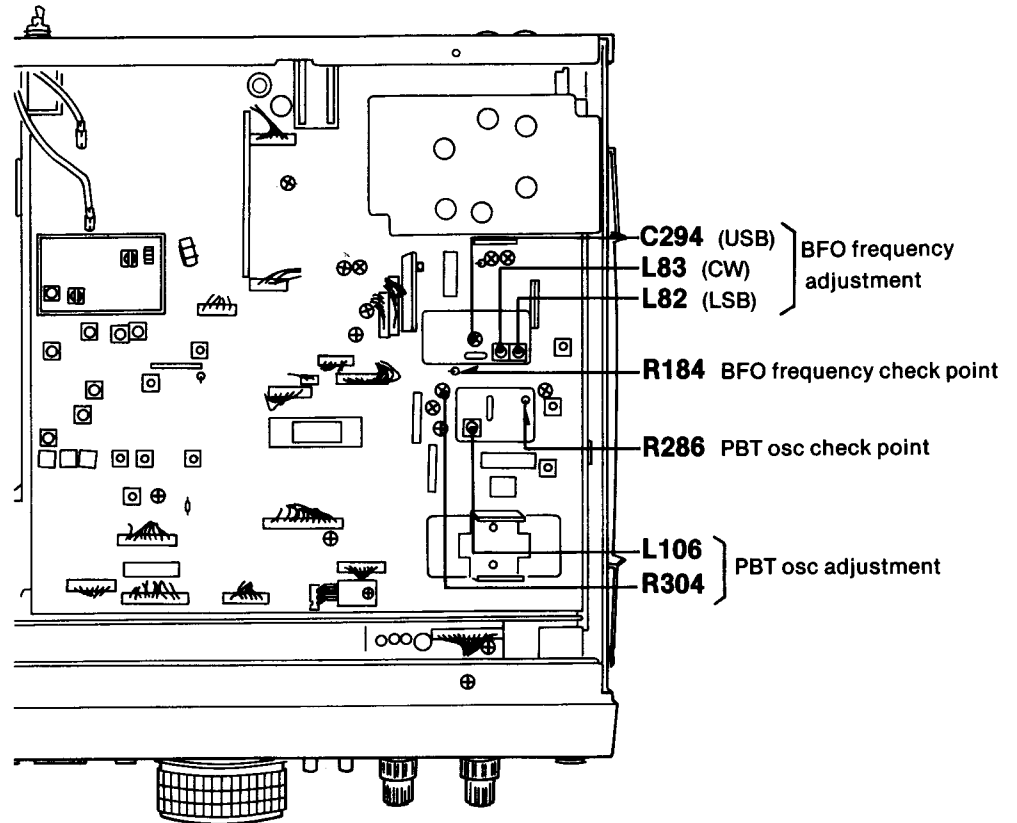

• MAIN UNIT
(for sensitivity adjustment)

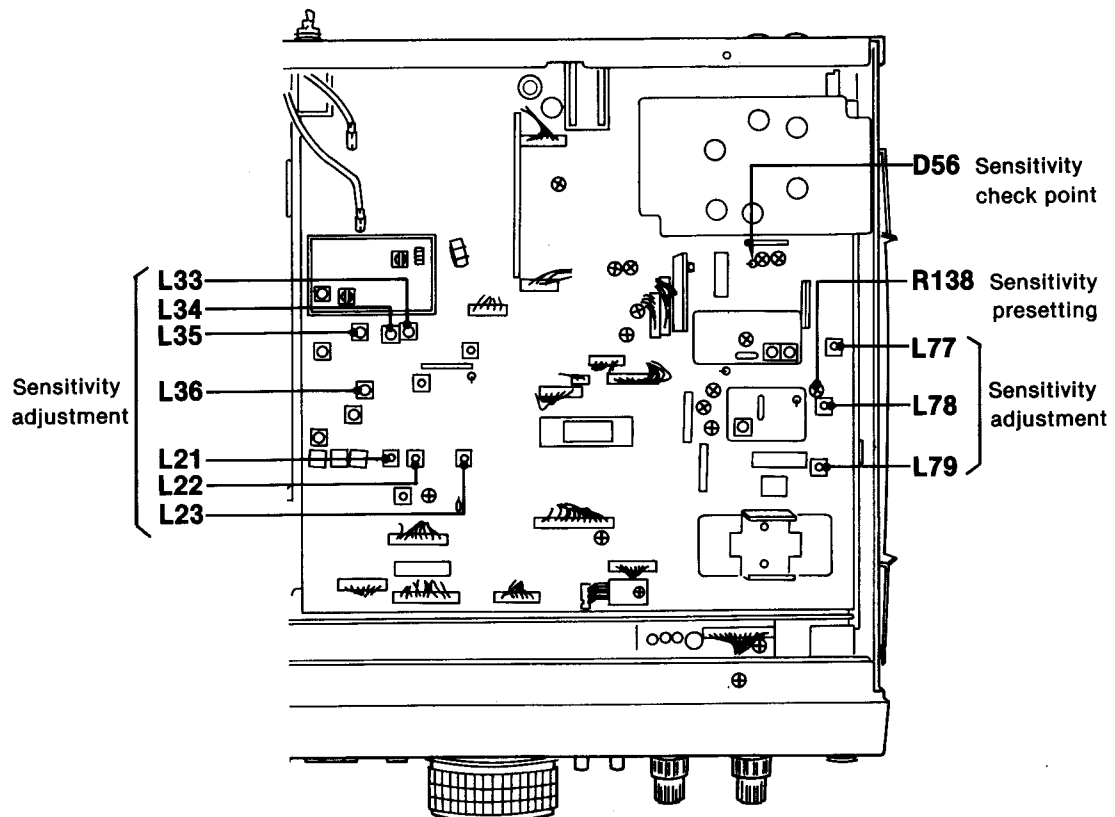

RECEIVER ADJUSTMENT (CONTINUED)

ADJUSTMENT	ADJUSTMENT CONDITIONS	MEASUREMENT		VALUE	ADJUSTMENT POINT	
		UNIT	LOCATION		UNIT	ADJUST
TOTAL GAIN	1	Rear panel	Connect the AC milli-voltmeter to the [EXT SP] jack with an 8 Ω load.	1.0 V (0 dB)	Front panel	[AF] control
	2					
S-METER	1	Front panel	S-METER	S9	MAIN	R110
	2					
	3	Repeat steps 1 and 2 several times.				
FM S-METER	NOTE: Be sure that R14 in the FMAM unit is turned max. counterclockwise.					
NOISE BLANKER	1	MAIN	Connect the oscilloscope to the cathode of D13.	Adjust for maximum waveform on the oscilloscope.	MAIN	L25, L26
	2					
BEEP TONE	NOTE: Be sure that R321 in the MAIN unit is set at center.					
DIMMER	1	DISPLAY	Connect the DC voltmeter to a soldering point of the DS1 lead wire (LAMP+).	11.0 V DC	AF	R18

* This output level of the standard signal generator (SSG) is indicated as SSG's open circuit.

RECEIVER ADJUSTMENT (CONTINUED)

ADJUSTMENT	ADJUSTMENT CONDITIONS	MEASUREMENT		VALUE	ADJUSTMENT POINT	
		UNIT	LOCATION		UNIT	ADJUST
NOTCH	<ul style="list-style-type: none"> • Displayed frequency: 14.10000 MHz • Mode : AM • [PRE AMP] switch : OFF • [NB] switch : OFF • [NOTCH] switch : ON • [NOTCH] control : Max. CW • Connect the SSG to the [ANT 1] connector and set as: Frequency : 14.1000 MHz Level : 1.0 mV* (-47 dBm) Modulation : 30% AM/3 kHz • Receiving 	Rear panel	Connect the AC milli-voltmeter to the [EXT SP] jack with an 8 Ω load.	Minimum voltage	Front panel	[NOTC] control
				Minimum voltage	NOTCH	R8
	Confirm that the minimum voltage point exits while rotating the [NOTCH] control to counterclockwise.				Verify	
2	<ul style="list-style-type: none"> • Set the SSG as: Modulation : 30% AM/500 Hz 					

* This output level of the standard signal generator (SSG) is indicated as SSG's open circuit.

• MAIN AND AF UNITS AND NOTCH BOARD

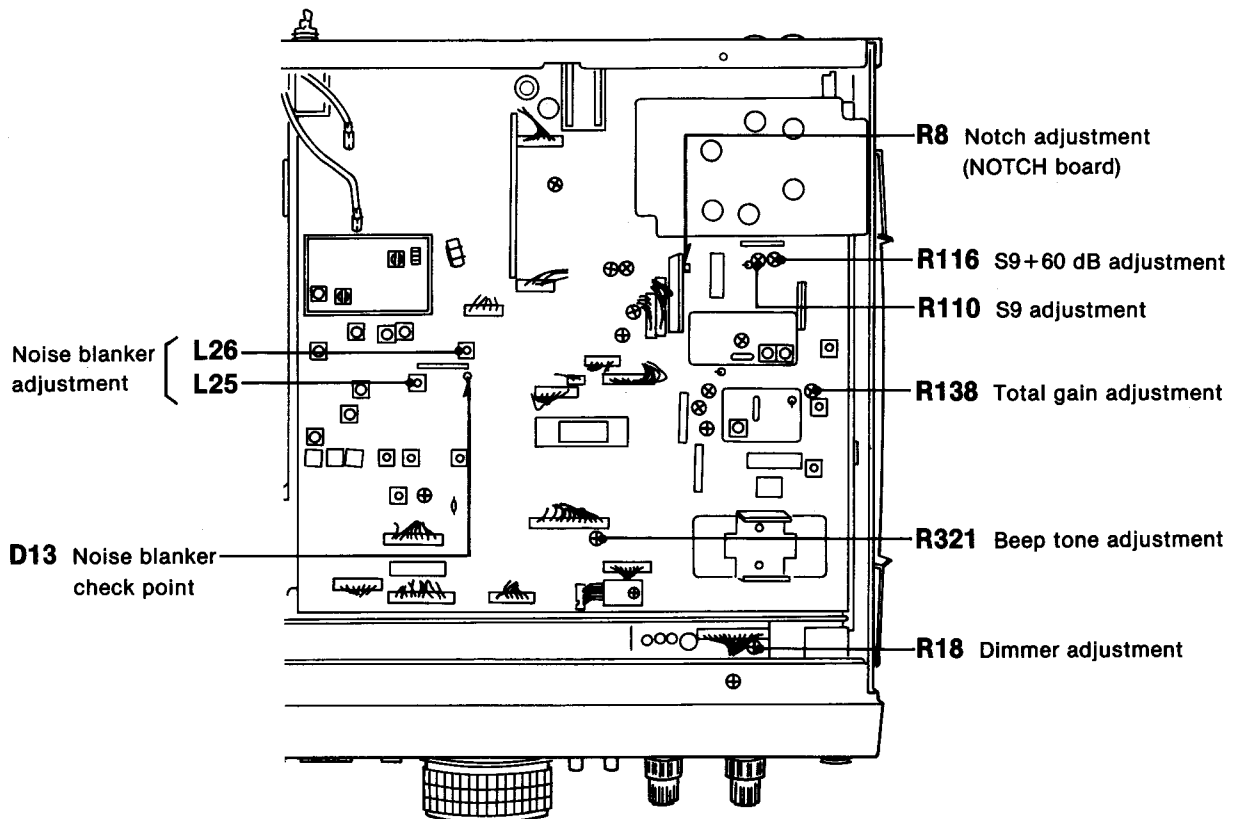

• DISPLAY UNIT

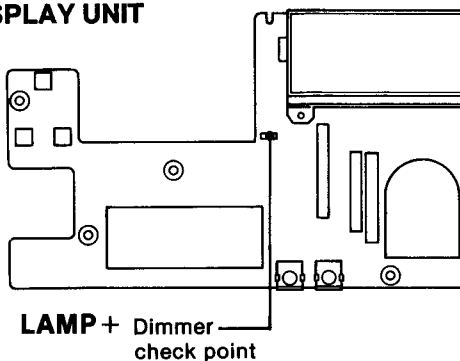

• FMAM UNIT

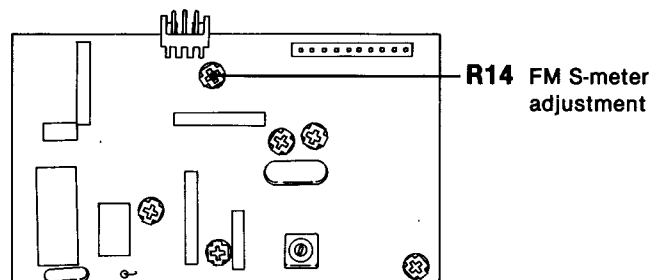

5-4 TRANSMITTER ADJUSTMENT

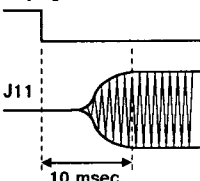
ADJUSTMENT	ADJUSTMENT CONDITIONS	MEASUREMENT		VALUE	ADJUSTMENT POINT	
		UNIT	LOCATION		UNIT	ADJUST
IDLING CURRENT Ⓐ For drive transistors	<ul style="list-style-type: none"> • Displayed frequency: 14.10000 MHz • Mode : CW • [TRANSMIT] switch : IN • [KEY] jack : No connection • [RF PWR] control : Max. CW • [ANT] switch : ANT 1 • [TUNER] switch : OFF 	PA	Unsolder W14 and connect the ammeter to the unsoldering points.	100 mA	PA	R8
						R19
	Ⓑ For final transistors	<ul style="list-style-type: none"> • Re-solder W14. 		Unsolder R26 and connect the ammeter to the unsoldering points.	300 mA	
	3 After adjustment, re-solder W14 and R26.					
SWR DETECTOR	<ul style="list-style-type: none"> • Displayed frequency: 14.10000 MHz • Mode : USB • [RF PWR] control : Max. CW • [ANT] switch : ANT 1 • Connect the jumper wire between R87 (MAIN unit) and a ground. • Connect the audio generator to the [MICROPHONE] connector and set as: Level : 10 mV Frequency : 1.5 kHz • Transmitting 	Rear panel	Connect the RF power meter to the [ANT 1] connector.	100 W	Front panel	[MIC] control
		MAIN	Connect the DC voltmeter to J6 (pin 6).	Minimum	FILTER	C54
	3 After adjustment, remove the jumper wire from R87.					
TRANSMIT GAIN	<ul style="list-style-type: none"> • Displayed frequency: 14.10000 MHz • Mode : USB • [RF PWR] control : Max. CW • R85, R210 (MAIN unit): Max. CW • R194 (MAIN unit) : Max. CCW • [ANT] switch : ANT 1 • Connect the audio generator to the [MICROPHONE] connector and set as: Level : 3 mV Frequency : 1.5 kHz • Transmitting 	Rear panel	Connect the RF power meter to the [ANT 1] connector.	50 W	Front panel	[MIC] control
				Maximum	MAIN	L37, L17, L16, L14, L7
		<ul style="list-style-type: none"> • [MIC] control : Center 			50 W	
NOTE: Adjust the [MIC] control to keep the output power at 50W for each adjustment.						
CW DELAY TIME	<ul style="list-style-type: none"> • Displayed frequency: 14.10000 MHz • Mode : CW • [TRANSMIT] switch : ON (IN) • [RF PWR] control : Max. CCW • [KEY SPEED] control: Max. CW • [ELEKEY] switch : ON (IN) • Connect a keyer to the [KEY] jack and key down. 	MAIN	Connect the oscilloscope to J11 and the key or paddle.	Adjust as follows: Keying 	MAIN	R241

• PA AND FILTER UNITS

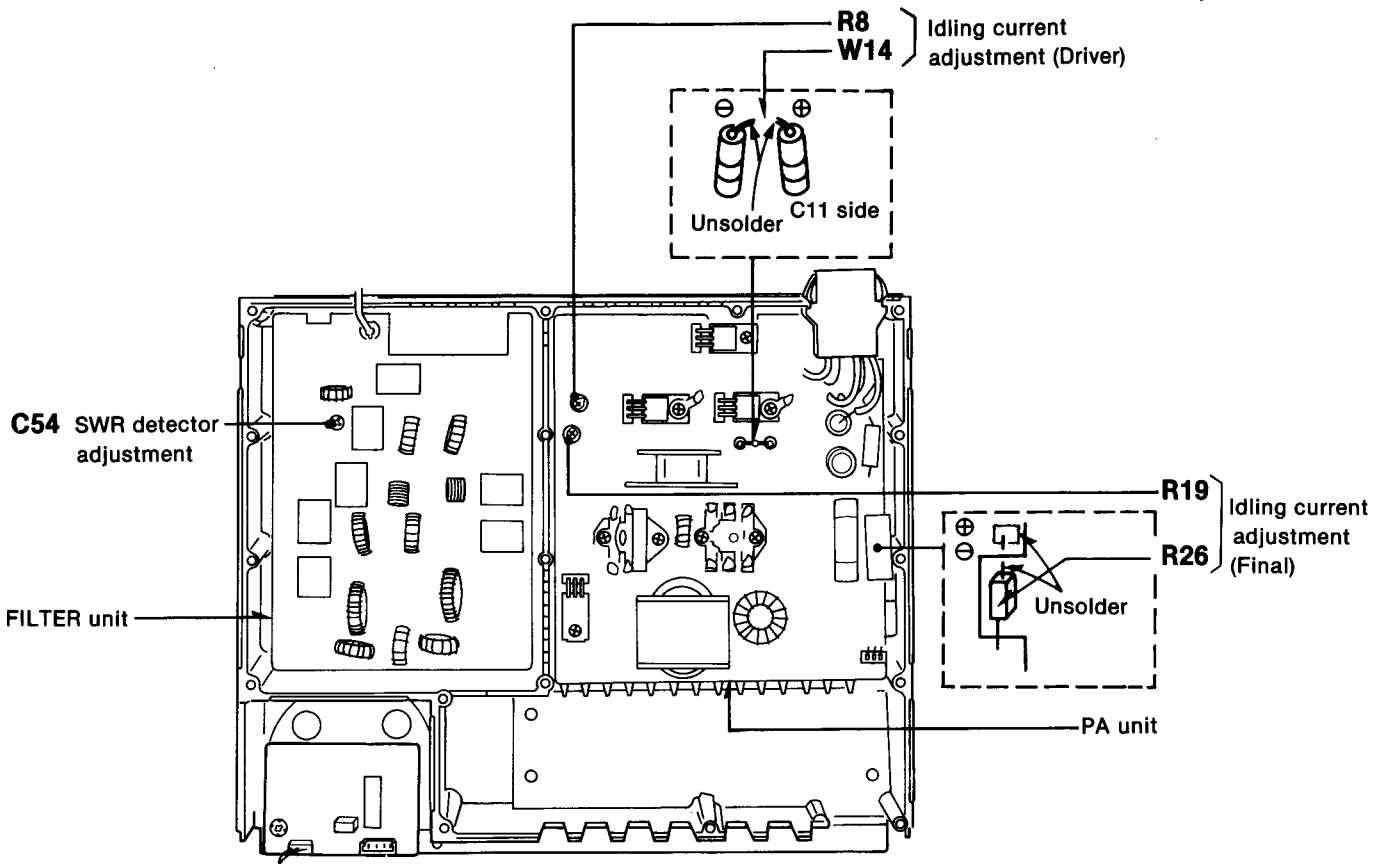

• MAIN UNIT

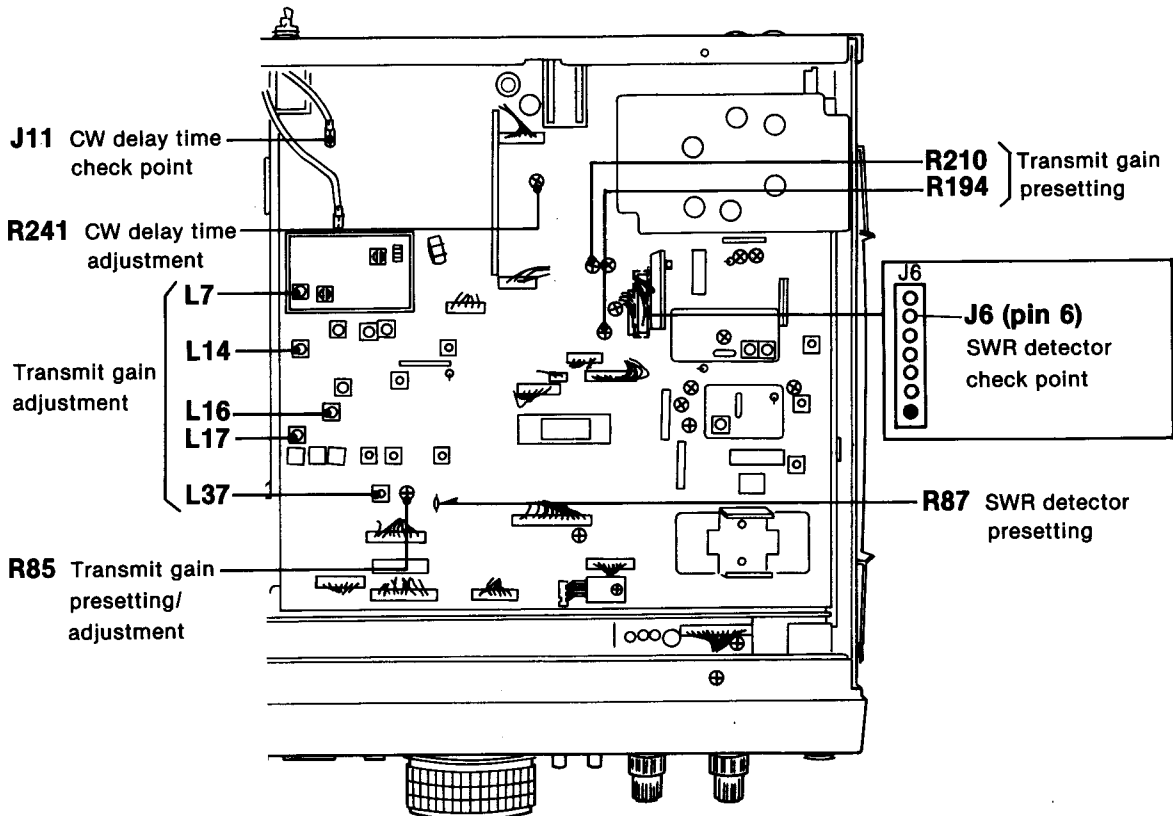

TRANSMITTER ADJUSTMENT (CONTINUED)

ADJUSTMENT	ADJUSTMENT CONDITIONS	MEASUREMENT		VALUE	ADJUSTMENT POINT			
		UNIT	LOCATION		UNIT	ADJUST		
OUTPUT POWER	1	<ul style="list-style-type: none"> • Displayed frequency: 28.50000 MHz • Mode : CW • [TRANSMIT] switch : ON (IN) • [TUNER] switch : OFF • [RF PWR] control : Max. CW • [ELEKEY] switch : OFF (OUT) • Connect a keyer to the [KEY] jack and key down. 	Rear panel	Connect the RF power meter to the [ANT 1] connector.	100 W	MAIN	R210	
	2	<ul style="list-style-type: none"> • Mode : AM 					40 W	R208
	3	<ul style="list-style-type: none"> • Mode : CW • [RF PWR] control : Max. CCW 					5–15 W	Verify
	4	Repeat steps 1–3 several times.						
Ic APC	1	<ul style="list-style-type: none"> • Displayed frequency: 14.10000 MHz • Mode : CW • [TRANSMIT] switch : ON (IN) • [TUNER] switch : OFF • [RF PWR] control : Max. CW • Connect the jumper wire between J6 (pin 5, MAIN unit) and a ground. • Connect a keyer to the [KEY] jack and key down. 	Rear panel	Connect the ammeter between the DC power supply and IC-737.	22 A	MAIN	R194	
	2	After adjustment, remove the jumper wire from J6 (pin 5).						
Po METER	1	<ul style="list-style-type: none"> • Displayed frequency: 14.10000 MHz • Mode : CW • [TRANSMIT] switch : ON (IN) • [RF PWR] control : Max. CW • Connect a keyer to the [KEY] jack and key down. 	Front panel	S-METER	100%	MAIN	R186	
CARRIER SUPPRESSION	1	<ul style="list-style-type: none"> • Displayed frequency: 14.10000 MHz • Mode : USB and LSB • [MIC] control : Max. CCW • Apply no signal to the [MICROPHONE] connector. • Transmitting 	Rear panel	Connect the spectrum analyzer to the [ANT 1] connector via the attenuator.	Minimum carrier level (Less than – 50 dB)	MAIN	R177, R179 (Alternate adjustment)	
KEYING WEIGHT	NOTE: Be sure that R8 in the ELEKEY unit is turned max. counterclockwise.							
FM-AM OSC FREQUENCY	1	<ul style="list-style-type: none"> • Displayed frequency: 29.10000 MHz • Mode : FM • R26 (FMAM unit) : Max. CW • R47 (FMAM unit) : Max. CCW • Transmitting 	FMAM	Connect the frequency counter to the cathode of D1.	9.01000 MHz	FMAM	L3	

• MAIN UNIT

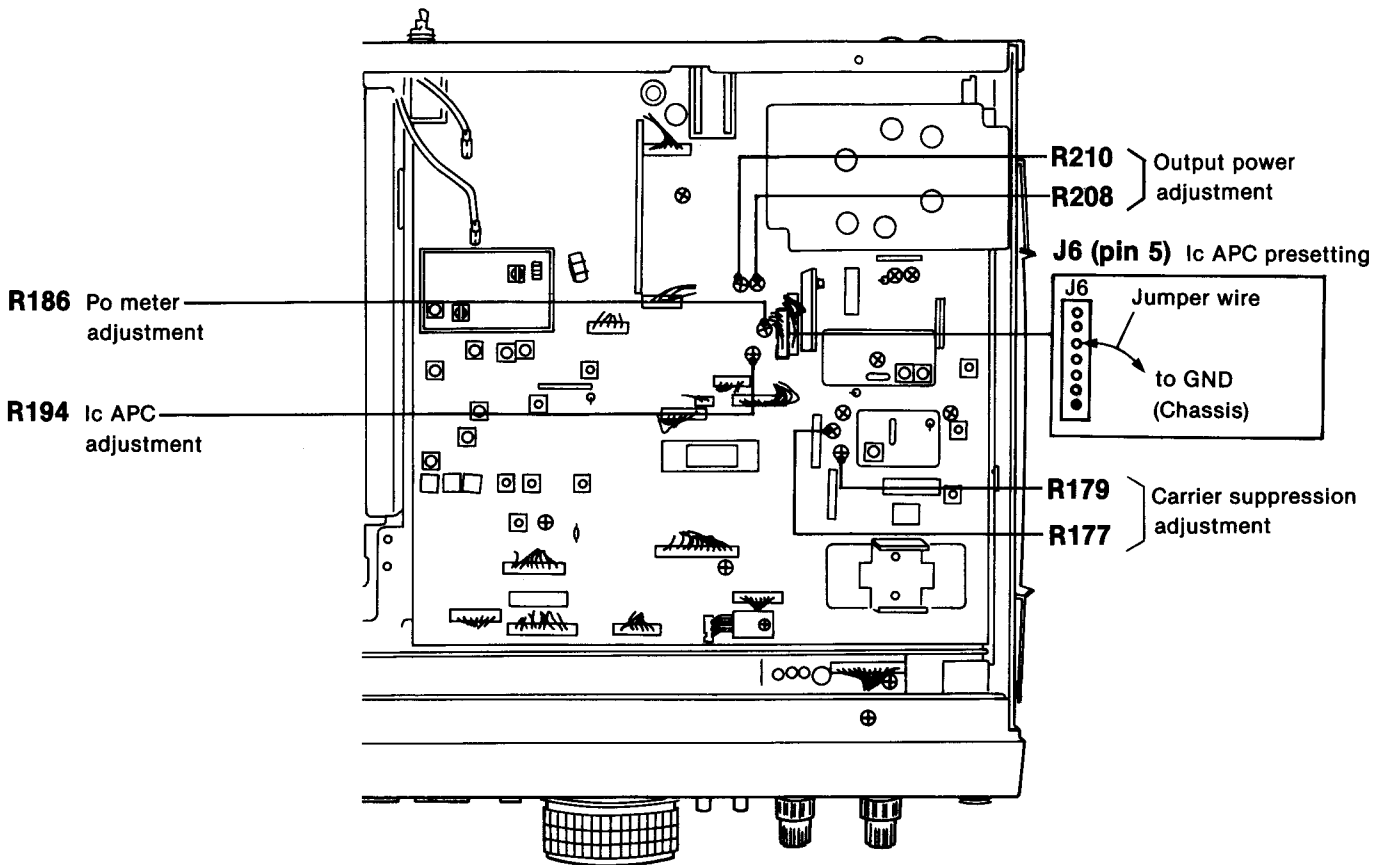

• FMAM UNIT

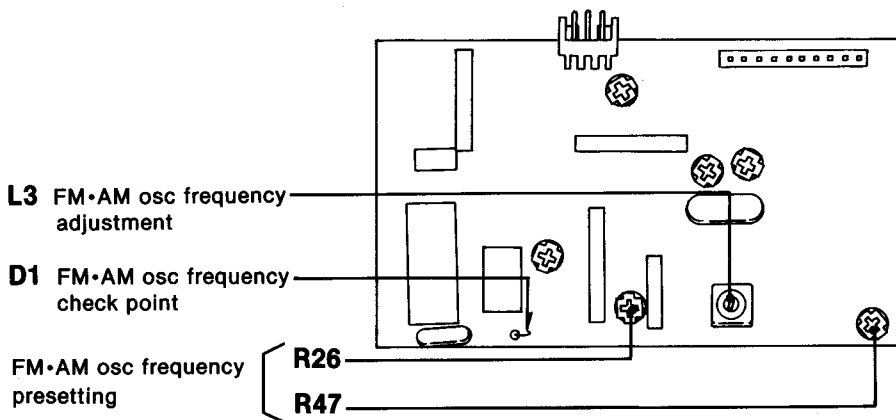

• ELEKEY UNIT

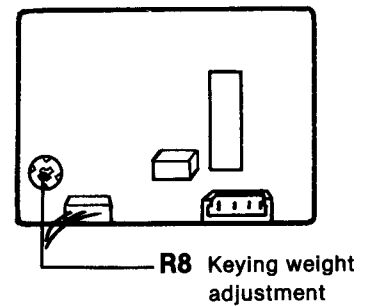

TRANSMITTER ADJUSTMENT (CONTINUED)

ADJUSTMENT	ADJUSTMENT CONDITIONS	MEASUREMENT		VALUE	ADJUSTMENT POINT	
		UNIT	LOCATION		UNIT	ADJUST
FM DEVIATION	1 <ul style="list-style-type: none"> • Displayed frequency: 29.10000 MHz • Mode : FM • [MIC] control : Max. CW • Connect the audio generator to the [MICROPHONE] connector and set as: <ul style="list-style-type: none"> Level : 10 mV Frequency : 1 kHz • Set the FM deviation meter as: <ul style="list-style-type: none"> HPF : 50 Hz LPF : 20 kHz De-emphasis: OFF Detector : (P - P)/2 • Transmitting 	FMAM	Connect the FM deviation meter to the [ANT 1] connector via the attenuator.	± 4.8 kHz	FMAM	R41
	2 <ul style="list-style-type: none"> • [MIC] control : Center • Set the audio generator as: <ul style="list-style-type: none"> Level : 1 mV 					± 3.5 kHz
	3 <ul style="list-style-type: none"> • Repeat steps 1 and 2 several times. 					
CARRIER LEVEL	1 <ul style="list-style-type: none"> • Displayed frequency: 29.10000 MHz • Mode : FM • R28 (FMAM unit) : Center • Transmitting 	FMAM	Connect the oscilloscope to the cathode of D1.	350 mVp-p	FMAM	R47
AM MODULATION	1 <ul style="list-style-type: none"> • Displayed frequency: 29.10000 MHz • Mode : AM • R44 (FMAM unit) : Center • [MIC] control : Max. CW • Connect the audio generator to the [MICROPHONE] connector and set as: 	FMAM	Connect the modulation analyzer to the [ANT 1] connector via the attenuator.	Maximum level	Audio generator output frequency	
	2 <ul style="list-style-type: none"> • Level : 1 mV • Frequency : 1 kHz • Transmitting 			70% modulation	FMAM	R44

• FMAM UNIT

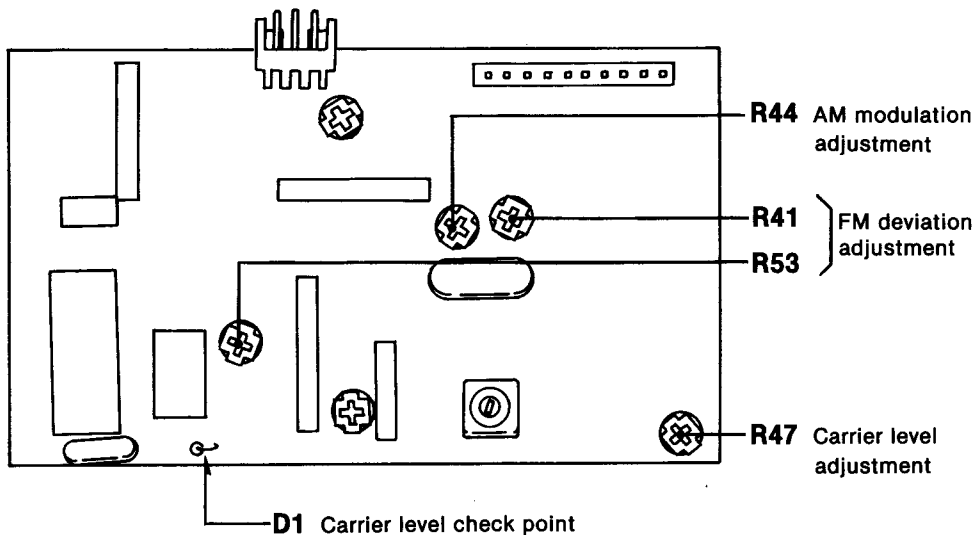

5-5 ANTENNA TUNER ADJUSTMENT

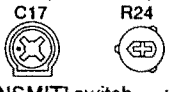
ADJUSTMENT	ADJUSTMENT CONDITIONS	MEASUREMENT		VALUE	ADJUSTMENT POINT				
		UNIT	LOCATION		UNIT	ADJUST			
REFERENCE VOLTAGE	1	<ul style="list-style-type: none"> Displayed frequency: 14.10000 MHz Mode : USB Disconnect J4 and J5 (CTRL unit). Connect the jumper wire between R151 (CTRL unit) and a ground. De-solder W8 (CTRL unit). Connect the power meter or 50 Ω dummy load to J1. Transmitting 	CTRL	Connect the digital multimeter or oscilloscope to W26.	4.6–5.0 V DC	CTRL	Verify		
	2			Connect the digital multimeter or oscilloscope to R64.			Half the value of the W26 voltage. (Step 1 above)	R61	
	3			Connect the digital multimeter or oscilloscope to R54.			Half the value of the W26 voltage. (Step 1 above)	R51	
	4			<ul style="list-style-type: none"> Mode : CW C17, R24 (CTRL unit) : Center 			Connect the digital multimeter or oscilloscope to R64.	Half the value of the W26 voltage. (Step 1 above)	C38
	5			<ul style="list-style-type: none"> [TRANSMIT] switch : ON (IN) [RF PWR] control : Max. CW Connect a keyer to the [KEY] jack and key down. 			Connect the digital multimeter or oscilloscope to R54.	Half the value of the W26 voltage. (Step 1 above)	C17, R24
NOTE: Keep the presettings of the jumper wire at R151, P1, P2, W8 and the 50 Ω resistor until the following adjustment is completed.									
SWR DETECTOR	1	<ul style="list-style-type: none"> Displayed frequency: 1.91000 MHz Mode : CW [TRANSMIT] switch : ON (IN) [RF PWR] control : Max. CW Connect a keyer to the [KEY] jack and key down. 	CTRL	Connect the digital multimeter or oscilloscope to J14.	Minimum voltage	CTRL	C11		
	2			Connect the digital multimeter or oscilloscope to R32.			Adjust R27 volume to the point where the voltage just changes from 5 V to 0 V.	R27	
	3			After adjustment, remove the jumper wire from R151. Re-plug P1 and P2. Re-solder W8. Remove the 150 Ω resistor.					

• CTRL UNIT

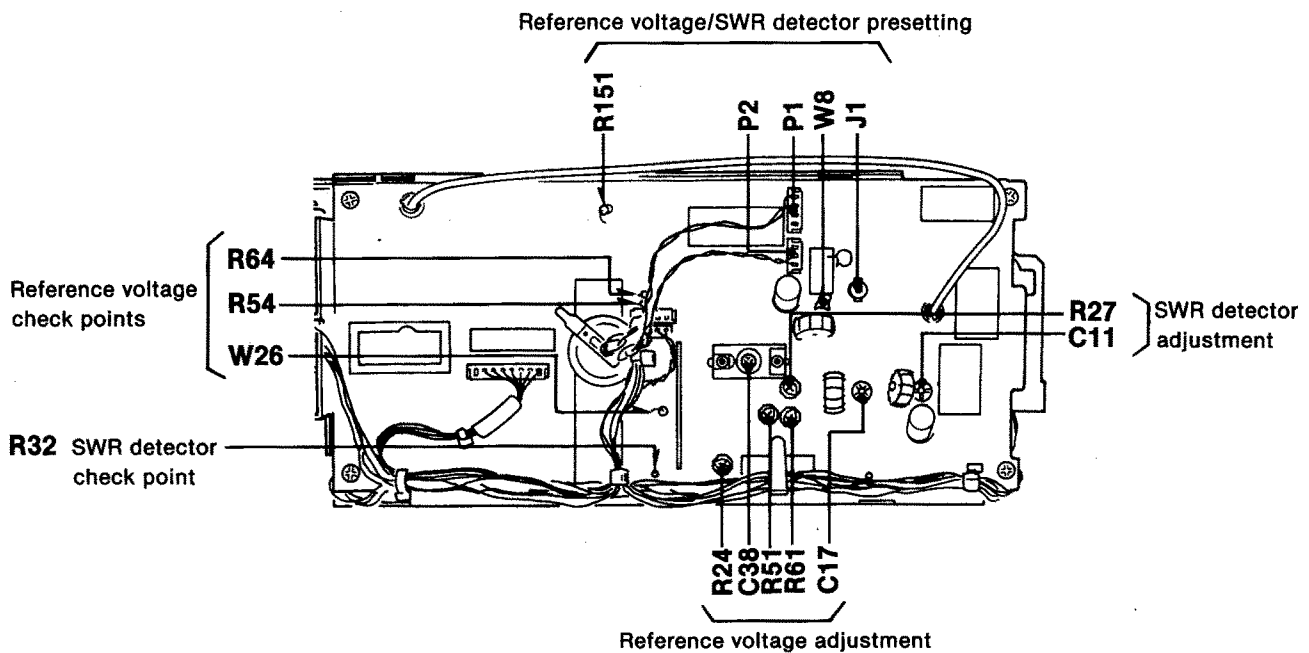

SECTION 6 PARTS LIST

[FRONT PARTS]

REF. NO.	ORDER NO.	DESCRIPTION	
R1	7010004190	RESISTOR	R20J 1 kΩ
DS1	5080000310	LAMP	HRS-4200A H-9 L150
ME1	5510000400	METER	ME-32 (MG-113S) [S/RF METER]
S1	2250000110	ENCODER	SW-147 (EC24B50B) [MAIN DIAL]
W4	7120000010	JUMPER	JPW 02A

[DISPLAY UNIT]

REF. NO.	ORDER NO.	DESCRIPTION	
C8	4040000150	BARRIER	UAT 05X 472K
C9	4020000650	CYLINDER	EP050 X 472M
C10	4020000650	CYLINDER	EP050 X 472M
DS1	5030000910	LCD	FTD-11668AAPH [FUNCTION DISPLAY]
DS3	5080000305	LAMP	HRT-3290A-F
DS4	5080000305	LAMP	HRT-3290A-F
DS5	5080000305	LAMP	HRT-3290A-F
DS6	5080000305	LAMP	HRT-3290A-F
S1	2260001580	SWITCH	JPZ2120-0101 (TV-3) [POWER]
S2	2230000800	SWITCH	SW-112 (SPPH24) [TRANSMIT]
S3	2230000800	SWITCH	SW-112 (SPPH24) [BK-IN]
S4	2230000800	SWITCH	SW-112 (SPPH24) [FULL]
J1	6510015500	CONNECTOR	5224-15CHPB
J3	6510015310	CONNECTOR	5224-13CHPB
EP1	0910037405	PCB	B 3660E (DISPLAY)

[DISPLAY UNIT]

REF. NO.	ORDER NO.	DESCRIPTION	
IC1	1130004190	S. IC	LC7582A
IC2	1130004190	S. IC	LC7582A
Q2	1530000110	TRANSISTOR	2SC2458-GR
D1	1730000110	ZENER	RD5.6E B2
L1	6180000900	COIL	LAL 03NA 101K
L2	6180000900	COIL	LAL 03NA 101K
L3	6180000900	COIL	LAL 03NA 101K
L4	6180000900	COIL	LAL 03NA 101K
L5	6180000900	COIL	LAL 03NA 101K
L6	6180000900	COIL	LAL 03NA 101K
L7	6180001510	COIL	LAL 02NA 101K
R1	7010004311	RESISTOR	R20 T-24J 8.2 kΩ
R2	7010004241	RESISTOR	R20 T-24J 2.7 kΩ
R3	7010004191	RESISTOR	R20 T-24J 1 kΩ
R4	7010004111	RESISTOR	R20 T-24J 220 Ω
R5	7010004720	RESISTOR	R50XJ 100 Ω
R6	7010004720	RESISTOR	R50XJ 100 Ω
R8	7010004411	RESISTOR	R20 T-24J 47 kΩ
R9	7010004411	RESISTOR	R20 T-24J 47 kΩ
R16	7210002190	VARIABLE	EVU-FLAEA4 B14 (10KB) [RF PWR]
R17	7210001880	VARIABLE	EVU-FLAEA4 C13 (1KC) [COMP LEVEL]
C1	4010000480	CERAMIC	DD104 B 681K 50V
C2	4560000020	CERAMIC	D33Y5V 1E 104Z21
C3	4010000480	CERAMIC	DD104 B 681K 50V
C4	4560000020	CERAMIC	D33Y5V 1E 104Z21
C5	4020000650	CYLINDER	EP050 X 472M
C6	4020000650	CYLINDER	EP050 X 472M
C7	4020000650	CYLINDER	EP050 X 472M

[MIC AMP BOARD]

REF. NO.	ORDER NO.	DESCRIPTION	
Q1	1530002860	S. TRANSISTOR	2SC3324-BL (TE85R)
R1	7030003440	S. RESISTOR	ERJ3GEYJ 102 V (1 kΩ)
R2	7030003520	S. RESISTOR	ERJ3GEYJ 472 V (4.7 kΩ)
R3	7030003640	S. RESISTOR	ERJ3GEYJ 473 V (47 kΩ)
R4	7030003400	S. RESISTOR	ERJ3GEYJ 471 V (470 Ω)
R5	7030003440	S. RESISTOR	ERJ3GEYJ 102 V (1 kΩ)
R6	7030003280	S. RESISTOR	ERJ3GEYJ 470 V (47 Ω)
C1	4550000460	S. TANTALUM	TESVA 1C 105M1-8L
C2	4550000460	S. TANTALUM	TESVA 1C 105M1-8L
C3	4550002770	S. TANTALUM	TESVD2 1C 226M-12L
C4	4550002770	S. TANTALUM	TESVD2 1C 226M-12L
C5	4030006880	S. CERAMIC	C1608 JB 1H 472K-T-A
C6	4550000280	S. TANTALUM	TESVB2 1A 475M-8L
C7	4550002720	S. TANTALUM	TESVD2 0J 476M-12L
EP1	0910037700	PCB	B 3738 (MIC AMP)
EP2	6510008510	LEADFRAME	PT2.54-1.0-20 (L)

S.=Surface mount

[SW UNIT]

REF. NO.	ORDER NO.	DESCRIPTION	
D1	1710000611	DIODE	1SS133 T77 (26M/M)
D2	1710000611	DIODE	1SS133 T77 (26M/M)
D3	1710000611	DIODE	1SS133 T77 (26M/M)
D4	1710000611	DIODE	1SS133 T77 (26M/M)
D5	1710000611	DIODE	1SS133 T77 (26M/M)
D6	1710000611	DIODE	1SS133 T77 (26M/M)
D7	1710000611	DIODE	1SS133 T77 (26M/M)
D8	1710000611	DIODE	1SS133 T77 (26M/M)
D9	1710000160	DIODE	1SS133
D10	1710000611	DIODE	1SS133 T77 (26M/M)
D11	1710000611	DIODE	1SS133 T77 (26M/M)
D12	1710000611	DIODE	1SS133 T77 (26M/M)
D13	1710000611	DIODE	1SS133 T77 (26M/M)
D14	1710000611	DIODE	1SS133 T77 (26M/M)
D15	1710000611	DIODE	1SS133 T77 (26M/M)
D16	1710000160	DIODE	1SS133
D17	1710000611	DIODE	1SS133 T77 (26M/M)
D18	1710000611	DIODE	1SS133 T77 (26M/M)
D19	1710000160	DIODE	1SS133
D20	1710000611	DIODE	1SS133 T77 (26M/M)
D21	1710000611	DIODE	1SS133 T77 (26M/M)
D22	1710000611	DIODE	1SS133 T77 (26M/M)
D23	1710000611	DIODE	1SS133 T77 (26M/M)
D24	1710000611	DIODE	1SS133 T77 (26M/M)
D25	1710000160	DIODE	1SS133
D26	1710000611	DIODE	1SS133 T77 (26M/M)
D27	1710000611	DIODE	1SS133 T77 (26M/M)
D28	1710000611	DIODE	1SS133 T77 (26M/M)
D29	1710000160	DIODE	1SS133
D30	1710000611	DIODE	1SS133 T77 (26M/M)
D31	1710000611	DIODE	1SS133 T77 (26M/M)
D32	1710000611	DIODE	1SS133 T77 (26M/M)
D33	1710000611	DIODE	1SS133 T77 (26M/M)
D34	1710000611	DIODE	1SS133 T77 (26M/M)
D35	1710000160	DIODE	1SS133
D36	1710000611	DIODE	1SS133 T77 (26M/M)
D37	1710000611	DIODE	1SS133 T77 (26M/M)
D38	1710000611	DIODE	1SS133 T77 (26M/M)
D39	1710000611	DIODE	1SS133 T77 (26M/M)
D40	1710000160	DIODE	1SS133
D41	1710000160	DIODE	1SS133
D42	1710000160	DIODE	1SS133
D43	1710000611	DIODE	1SS133 T77 (26M/M)
D44	1710000611	DIODE	1SS133 T77 (26M/M)
R1	7010004191	RESISTOR	R20 T-24J 1 kΩ
R2	7010004191	RESISTOR	R20 T-24J 1 kΩ
R3	7010004191	RESISTOR	R20 T-24J 1 kΩ
R4	7010004191	RESISTOR	R20 T-24J 1 kΩ
R5	7010004191	RESISTOR	R20 T-24J 1 kΩ
R6	7010004191	RESISTOR	R20 T-24J 1 kΩ
R7	7010004191	RESISTOR	R20 T-24J 1 kΩ
R8	7010004191	RESISTOR	R20 T-24J 1 kΩ
R9	7010004191	RESISTOR	R20 T-24J 1 kΩ
R10	7010001131	RESISTOR	R25X T-24J 680 Ω
R11	7010001151	RESISTOR	R25X T-24J 1 kΩ
DS1	5040001730	LED	TLR221 [NOTCH]
DS2	5040001720	LED	TLG221 [RECEIVE]
DS3	5040001730	LED	TLR221 [TRANSMIT]
S1	2260001810	SWITCH	SW-142 (SKHQFF) [TUNER]
S2	2260000080	SWITCH	SKHHAM024A [SSB]
S3	2260000080	SWITCH	SKHHAM024A [XFC]
S4	2260001810	SWITCH	SW-142 (SKHQFF) [FREQ-INP]
S5	2260000080	SWITCH	SKHHAM024A [VFO/MEMO]
S6	2260000080	SWITCH	SKHHAM024A [M▶VFO]
S7	2260001810	SWITCH	SW-142 (SKHQFF) [PRE AMP]

[SW UNIT]

REF. NO.	ORDER NO.	DESCRIPTION	
S8	2260000080	SWITCH	SKHHAM024A [CW/N]
S9	2260000080	SWITCH	SKHHAM024A [TS]
S10	2260000080	SWITCH	SKHHAM024A [SPLIT]
S11	2260000080	SWITCH	SKHHAM024A [MW]
S12	2260000080	SWITCH	SKHHAM024A [CLEAR]
S13	2260001810	SWITCH	SW-142 (SKHQFF) [ATT]
S14	2260000080	SWITCH	SKHHAM024A [AM]
S15	2260000080	SWITCH	SKHHAM024A [A/B]
S16	2260000080	SWITCH	SKHHAM024A [A=B]
S17	2260000080	SWITCH	SKHHAM024A [SEL]
S18	2260000080	SWITCH	SKHHAM024A [SCAN]
S19	2260001860	SWITCH	SW-148 (SKHBBW) [ANT]
S20	2260000080	SWITCH	SKHHAM024A [FM/TONE]
S21	2260000080	SWITCH	SKHHAM024A [1.8□]
S22	2260000080	SWITCH	SKHHAM024A [3.5□]
S23	2260000080	SWITCH	SKHHAM024A [7□]
S24	2260001860	SWITCH	SW-148 (SKHBBW) [TUNE]
S25	2260000080	SWITCH	SKHHAM024A [MP-W]
S26	2260000080	SWITCH	SKHHAM024A [10□]
S27	2260000080	SWITCH	SKHHAM024A [14□]
S28	2260000080	SWITCH	SKHHAM024A [18□]
S29	2260001810	SWITCH	SW-142 (SKHQFF) [AGC]
S30	2260000080	SWITCH	SKHHAM024A [MP-R]
S31	2260000080	SWITCH	SKHHAM024A [21□]
S32	2260000080	SWITCH	SKHHAM024A [24.5□]
S33	2260000080	SWITCH	SKHHAM024A [28□]
S34	2260001860	SWITCH	SW-148 (SKHBBW) [RIT]
S35	2260001810	SWITCH	SW-142 (SKHQFF) [NB]
S36	2260000080	SWITCH	SKHHAM024A [GENE□]
S37	2260000080	SWITCH	SKHHAM024A [29□]
S38	2260000080	SWITCH	SKHHAM024A [ENT]
S39	2260001860	SWITCH	SW-148 (SKHBBW) [ΔTX]
S40	2260001810	SWITCH	SW-142 (SKHQFF) [COMP]
S41	2260000080	SWITCH	SKHHAM024A [LOCK]
S42	2260000080	SWITCH	SKHHAM024A [DOWN]
S43	2260000080	SWITCH	SKHHAM024A [UP]
S44	2260001860	SWITCH	SW-148 (SKHBBW) [NOTCH]
J1	6510015510	CONNECTOR	SB15P-HVQ-C
J3	6510015240	CONNECTOR	SB13P-HVQ-C
EP1	0910037414	PCB	B 3683D (SW)

[LED BOARD]

REF. NO.	ORDER NO.	DESCRIPTION	
DS1	5040001730	LED	TLR221 [ANT1]
DS2	5040001730	LED	TLR221 [ANT2]
J1	6510015490	CONNECTOR	MB3P-90-2
EP1	0910037422	PCB	B 3684B (LED)

[AF UNIT]

REF. NO.	ORDER NO.	DESCRIPTION	
Q1	1530000110	TRANSISTOR	2SC2458-GR
Q2	1530000591	TRANSISTOR	2SC2785 EL
Q3	1530000180	TRANSISTOR	2SC2878-B
Q4	1590000340	TRANSISTOR	RN1202
D1	1710000580	DIODE	1SS265
D2	1710000580	DIODE	1SS265
R1	7210001990	VARIABLE	RV-233 (RK1242210) 10KB/10KA [SQL/AF]
R2	7210002270	VARIABLE	RV-279 (RK1242210) 250KC/10KB [KEY SPEED/MIC]
R3	7010003580	RESISTOR	ELR20J 22 kΩ
R4	7010003550	RESISTOR	ELR20J 15 kΩ
R5	7010003530	RESISTOR	ELR20J 10 kΩ
R6	7010004030	RESISTOR	R20J 47 Ω
R7	7010003480	RESISTOR	ELR20J 4.7 kΩ
R8	7010003660	RESISTOR	ELR20J 100 kΩ
R9	7010004450	RESISTOR	R20J 100 kΩ
R10	7010003580	RESISTOR	ELR20J 22 kΩ
R11	7010003530	RESISTOR	ELR20J 10 kΩ
R12	7010003420	RESISTOR	ELR20J 1.5 kΩ
R13	7010003400	RESISTOR	ELR20J 1 kΩ
R14	7010003360	RESISTOR	ELR20J 470 Ω
R15	7010003280	RESISTOR	ELR20J 100 Ω
R16	7010003660	RESISTOR	ELR20J 100 kΩ
R17	7010004450	RESISTOR	R20J 100 kΩ
R18	7310003200	TRIMMER	EVN-2ACA00 B14 (103)
C1	4510003800	ELECTROLYTIC	25 MV 4R7 SW
C2	4510004910	ELECTROLYTIC	16 MV 10 SWNP
C3	4510003840	ELECTROLYTIC	50 MV 1 SW
C4	4510005000	ELECTROLYTIC	16 MV 220 HC
C5	4010000520	CERAMIC	DD108 B 472K 50V
C6	4510003800	ELECTROLYTIC	25 MV 4R7 SW
C7	4510003800	ELECTROLYTIC	25 MV 4R7 SW
C8	4510004990	ELECTROLYTIC	16 MV 100 HC
J1	6510003470	CONNECTOR	B11B-EH-S
J2	6510003400	CONNECTOR	B04B-EH-S
J3	6510003410	CONNECTOR	B05B-EH-S
EP1	0910037363	PCB	B 3667C (AF)

[VR-A UNIT]

REF. NO.	ORDER NO.	DESCRIPTION	
R1	7210002300	VARIABLE	RV-282 (RK0971110) 10KB [PBT]
W1	7120000010	JUMPER	JPW 02A
W2	7120000010	JUMPER	JPW 02A
W3	7120000010	JUMPER	JPW 02A
EP1	0910037351	PCB	B 3666A (VR-A)

[VR-B UNIT]

REF. NO.	ORDER NO.	DESCRIPTION	
R1	7210002290	VARIABLE	RV-280 (RK0971110) 100KC [NOTCH]
J1	6510003390	CONNECTOR	B03B-EH-S
EP1	0910037381	PCB	B 3671A (VR-B)

[VR-C UNIT]

REF. NO.	ORDER NO.	DESCRIPTION	
R1	7210002280	VARIABLE	RV-281 (RK0971110) 10KB [RIT/ΔTX]
EP1	0910037391	PCB	B 3672A (VR-C)

[M-CH UNIT]

REF. NO.	ORDER NO.	DESCRIPTION	
D1	1710000160	DIODE	1SS133
D2	1710000160	DIODE	1SS133
S1	2260001870	SWITCH	SW-146 (SRBMIL) [M-CH]
W1	7120000010	JUMPER	JPW 02A
W2	7120000010	JUMPER	JPW 02A
W3	7120000010	JUMPER	JPW 02A
EP1	0910037341	PCB	B 3665A (M-CH)

[JACK UNIT]

REF. NO.	ORDER NO.	DESCRIPTION	
L1	6180000900	COIL	LAL 03NA 101K
R1	7010003280	RESISTOR	ELR20J 100 Ω
R2	7010003280	RESISTOR	ELR20J 100 Ω
C1	4020000250	CYLINDER	UP125 X 472M

[JACK UNIT]

REF. NO.	ORDER NO.	DESCRIPTION	
J1	6510003390	CONNECTOR	B03B-EH-S
J2	6450000191	CONNECTOR	HLJ4815-01-030 [PHONES]
W1	7120000010	JUMPER	JPW 02A
EP1	0910037371	PCB	B 3670A (JACK)

[MIC UNIT]

REF. NO.	ORDER NO.	DESCRIPTION	
J1	6510000190	CONNECTOR	FM214-8SS (P) [MICROPHONE]
EP1	0910006331	FPC	B 792A (MIC)

[MAIN UNIT]

REF. NO.	ORDER NO.	DESCRIPTION	
IC1	1790000050	IC	ND487C1-3R
IC2	1110003140	IC	LA1150N
IC4	1110002500	IC	M5218AL
IC5	1110001320	IC	μPC1037HA
IC6	1110001320	IC	μPC1037HA
IC7	1110001320	IC	μPC1037HA
IC8	1130000120	IC	TC4066BP
IC9	1110000890	IC	μPC1241H
IC10	1110002500	IC	M5218AL
IC11	1110002500	IC	M5218AL
IC12	1110001320	IC	μPC1037HA
IC13	1130003880	IC	GD4011B
IC14	1180000470	IC	NJM7808A
IC15	1120000970	IC	M54562P
Q1	1530000810	TRANSISTOR	2SC2053
Q2	1580000230	FET	3SK122 K
Q3	1580000230	FET	3SK122 K
Q4	1530000810	TRANSISTOR	2SC2053
Q5	1520000230	TRANSISTOR	2SB909M Q
Q6	1590000340	TRANSISTOR	RN1202
Q7	1560000100	FET	2SK241-Y
Q8	1560000620	FET	2SK937
Q9	1560000620	FET	2SK937
Q10	1590000360	TRANSISTOR	RN2202
Q11	1530000110	TRANSISTOR	2SC2458-GR
Q12	1590000340	TRANSISTOR	RN1202
Q13	1560000620	FET	2SK937
Q14	1560000620	FET	2SK937
Q15	1580000010	FET	3SK101-GR
Q16	1560000080	FET	2SK192A-Y
Q17	1510000080	TRANSISTOR	2SA1048-GR
Q18	1530000110	TRANSISTOR	2SC2458-GR
Q19	1530000110	TRANSISTOR	2SC2458-GR
Q20	1590000360	TRANSISTOR	RN2202
Q21	1580000010	FET	3SK101-GR
Q22	1560000100	FET	2SK241-Y

[MAIN UNIT]

REF. NO.	ORDER NO.	DESCRIPTION	
Q23	1590000340	TRANSISTOR	RN1202
Q24	1590000360	TRANSISTOR	RN2202
Q25	1590000360	TRANSISTOR	RN2202
Q26	1530000110	TRANSISTOR	2SC2458-GR
Q27	1580000010	FET	3SK101-GR
Q28	1560000100	FET	2SK241-Y
Q29	1530000110	TRANSISTOR	2SC2458-GR
Q30	1530000110	TRANSISTOR	2SC2458-GR
Q31	1530000110	TRANSISTOR	2SC2458-GR
Q32	1590000340	TRANSISTOR	RN1202
Q33	1590000350	TRANSISTOR	RN1204
Q34	1590000340	TRANSISTOR	RN1202
Q37	1530000110	TRANSISTOR	2SC2458-GR
Q38	1510000080	TRANSISTOR	2SA1048-GR
Q39	1590000350	TRANSISTOR	RN1204
Q40	1530000110	TRANSISTOR	2SC2458-GR
Q41	1590000360	TRANSISTOR	RN2202
Q42	1530000110	TRANSISTOR	2SC2458-GR
Q44	1530000180	TRANSISTOR	2SC2878-B
Q46	1540000070	TRANSISTOR	2SD468C
Q47	1540000070	TRANSISTOR	2SD468C
Q48	1540000150	TRANSISTOR	2SD1225M R
Q49	1530000110	TRANSISTOR	2SC2458-GR
Q50	1530000110	TRANSISTOR	2SC2458-GR
Q51	1590000340	TRANSISTOR	RN1202
Q52	1540000150	TRANSISTOR	2SD1225M R
Q53	1510000080	TRANSISTOR	2SA1048-GR
Q54	1590000350	TRANSISTOR	RN1204
Q55	1590000350	TRANSISTOR	RN1204
Q56	1530000110	TRANSISTOR	2SC2458-GR
Q57	1530000040	TRANSISTOR	2SC1815-Y
Q58	1530000110	TRANSISTOR	2SC2458-GR
Q59	1590000280	FET	2SJ105-Y
Q60	1590000350	TRANSISTOR	RN1204
Q61	1590000340	TRANSISTOR	RN1202
Q62	1590000350	TRANSISTOR	RN1204
Q64	1520000230	TRANSISTOR	2SB909M Q
Q65	1590000340	TRANSISTOR	RN1202
Q66	1590000340	TRANSISTOR	RN1202
Q67	1590000340	TRANSISTOR	RN1202
Q68	1590000340	TRANSISTOR	RN1202
Q69	1590000360	TRANSISTOR	RN2202
Q70	1590000340	TRANSISTOR	RN1202
Q71	1590000340	TRANSISTOR	RN1202
Q72	1590000340	TRANSISTOR	RN1202
Q73	1530000180	TRANSISTOR	2SC2878-B
Q74	1530000110	TRANSISTOR	2SC2458-GR
Q75	1590000340	TRANSISTOR	RN1202
Q76	1530000110	TRANSISTOR	2SC2458-GR
Q77	1530000110	TRANSISTOR	2SC2458-GR
D1	1710000050	DIODE	1SS53
D2	1710000050	DIODE	1SS53
D3	1710000050	DIODE	1SS53
D4	1710000050	DIODE	1SS53
D5	1710000050	DIODE	1SS53
D6	1710000050	DIODE	1SS53
D7	1710000050	DIODE	1SS53
D8	1710000050	DIODE	1SS53
D9	1710000050	DIODE	1SS53
D12	1710000330	DIODE	1K60
D13	1710000330	DIODE	1K60
D14	1710000160	DIODE	1SS133
D15	1710000050	DIODE	1SS53
D16	1710000050	DIODE	1SS53
D17	1710000160	DIODE	1SS133
D18	1710000050	DIODE	1SS53
D19	1710000050	DIODE	1SS53
D20	1710000050	DIODE	1SS53
D21	1710000050	DIODE	1SS53
D22	1710000160	DIODE	1SS133
D23	1710000050	DIODE	1SS53
D24	1710000050	DIODE	1SS53
D25	1710000050	DIODE	1SS53

[MAIN UNIT]

REF. NO.	ORDER NO.	DESCRIPTION
D26	1710000050	DIODE 1SS53
D27	1710000160	DIODE 1SS133
D28	1710000050	DIODE 1SS53
D29	1710000050	DIODE 1SS53
D30	1710000050	DIODE 1SS53
D31	1710000050	DIODE 1SS53
D32	1710000050	DIODE 1SS53
D33	1710000050	DIODE 1SS53
D34	1710000160	DIODE 1SS133
D35	1710000050	DIODE 1SS53
D36	1710000050	DIODE 1SS53
D37	1710000050	DIODE 1SS53
D38	1710000050	DIODE 1SS53
D39	1710000050	DIODE 1SS53
D40	1710000050	DIODE 1SS53
D41	1710000050	DIODE 1SS53
D42	1710000050	DIODE 1SS53
D43	1710000050	DIODE 1SS53
D44	1710000050	DIODE 1SS53
D45	1710000050	DIODE 1SS53
D46	1710000050	DIODE 1SS53
D47	1710000050	DIODE 1SS53
D48	1710000050	DIODE 1SS53
D49	1710000050	DIODE 1SS53
D50	1710000050	DIODE 1SS53
D51	1710000050	DIODE 1SS53
D52	1710000050	DIODE 1SS53
D53	1730001650	ZENER RD2.2E B1
D54	1730000060	ZENER RD3.6E B1
D55	1710000160	DIODE 1SS133
D56	1710000330	DIODE 1K60
D58	1710000160	DIODE 1SS133
D59	1790000070	DIODE 1SS237
D60	1790000070	DIODE 1SS237
D61	1710000611	DIODE 1SS133 T77 (26M/M)
D62	1710000330	DIODE 1K60
D63	1710000050	DIODE 1SS53
D64	1710000160	DIODE 1SS133
D65	1710000611	DIODE 1SS133 T77 (26M/M)
D66	1710000611	DIODE 1SS133 T77 (26M/M)
D67	1710000050	DIODE 1SS53
D68	1710000050	DIODE 1SS53
D69	1710000050	DIODE 1SS53
D70	1710000050	DIODE 1SS53
D71	1710000050	DIODE 1SS53
D72	1710000160	DIODE 1SS133
D73	1710000611	DIODE 1SS133 T77 (26M/M)
D76	1710000160	DIODE 1SS133
D77	1710000611	DIODE 1SS133 T77 (26M/M)
D78	1710000160	DIODE 1SS133
D80	1730000070	ZENER RD3.9E B2
D81	1710000160	DIODE 1SS133
D82	1710000160	DIODE 1SS133
D83	1710000160	DIODE 1SS133
D84	1710000160	DIODE 1SS133
D85	1710000160	DIODE 1SS133
D86	1710000611	DIODE 1SS133 T77 (26M/M)
D87	1710000611	DIODE 1SS133 T77 (26M/M)
D91	1710000160	DIODE 1SS133
D92	1710000160	DIODE 1SS133
D93	1710000611	DIODE 1SS133 T77 (26M/M)
D94	1710000160	DIODE 1SS133
D95	1710000160	DIODE 1SS133
D96	1710000611	DIODE 1SS133 T77 (26M/M)
D97	1710000030	DIODE 1S1555
D98	1710000611	DIODE 1SS133 T77 (26M/M)
D101	1720000230	VARICAP 1SV101
D102	1710000580	DIODE 1SS265
D103	1710000580	DIODE 1SS265
D104	1710000580	DIODE 1SS265
D105	1710000580	DIODE 1SS265
D109	1710000050	DIODE 1SS53
D110	1710000050	DIODE 1SS53
D111	1710000050	DIODE 1SS53
D113	1710000160	DIODE 1SS133

[MAIN UNIT]

REF. NO.	ORDER NO.	DESCRIPTION
D114	1710000160	DIODE 1SS133
D115	1710000160	DIODE 1SS133
D116	1710000611	DIODE 1SS133 T77 (26M/M)
D117	1710000580	DIODE 1SS265
D118	1710000580	DIODE 1SS265
D137	1730000170	ZENER RD8.2E B1
D138	1730000080	ZENER RD4.7E B2
D139	1710000160	DIODE 1SS133
X1	6050001800	XTAL CR-49
X2	6050001340	XTAL CR-1
F11	2010001010	FILTER 69M15B (FL-120)
F12	2010000270	FILTER 9M15A (FL-23)
F13	2010000320	FILTER 9M22D2 (FL-30)
F14	2020000150	CERAMIC CFW455HT
F15	2020000210	CERAMIC CFJ455K5 (FL-65)
L1	6140000080	COIL LR-20
L2	6180000690	COIL LAL 03NA R22M
L3	6180000700	COIL LAL 03NA R27M
L4	6180000860	COIL LAL 03NA 5R6K
L5	6180000960	COIL LAL 03NA 102K
L6	6140002050	COIL LR-224
L7	6150001770	COIL LS-198
L8	6110001620	COIL LA-245
L9	6180000900	COIL LAL 03NA 101K
L10	6140001460	COIL LR-170
L11	6140001260	COIL LR-151
L12	6180000730	COIL LAL 03NA R47M
L13	6180000690	COIL LAL 03NA R22M
L14	6150000990	COIL LS-114
L16	6150002430	COIL LS-254
L17	6150002430	COIL LS-254
L18	6140002060	COIL LR-225
L19	6140002060	COIL LR-225
L20	6180000900	COIL LAL 03NA 101K
L21	6150001840	COIL LS-180B
L22	6150000711	COIL LS-452
L23	6150000711	COIL LS-452
L24	6180000950	COIL LAL 03NA 150K
L25	6150004050	COIL LS-466
L26	6150004050	COIL LS-466
L27	6140000640	COIL LR-86
L28	6140001540	COIL LR-169
L29	6110001650	COIL LA-248
L30	6180000700	COIL LAL 03NA R27M
L31	6140002050	COIL LR-224
L32	6180000880	COIL LAL 03NA 100K
L33	6150001770	COIL LS-198
L34	6150002430	COIL LS-254
L35	6150002430	COIL LS-254
L36	6150000990	COIL LS-114
L37	6150001471	COIL LS-453
L38	6180000940	COIL LAL 03NA 270K
L39	6180000930	COIL LAL 03NA 220K
L40	6180000900	COIL LAL 03NA 101K
L41	6180000900	COIL LAL 03NA 101K
L42	6180002100	COIL EL0606SKI-6R8K
L43	6180002920	COIL LAL 02NA 5R6K
L44	6180000900	COIL LAL 03NA 101K
L45	6180000870	COIL LAL 03NA 6R8K
L46	6180000850	COIL LAL 03NA 4R7K
L47	6180000900	COIL LAL 03NA 101K
L48	6180000810	COIL LAL 03NA 2R2M
L49	6180000810	COIL LAL 03NA 2R2M
L50	6180000830	COIL LAL 03NA 3R3K
L51	6180000850	COIL LAL 03NA 4R7K
L52	6180000900	COIL LAL 03NA 101K
L53	6180000800	COIL LAL 03NA 1R8M
L54	6180000780	COIL LAL 03NA 1R2M
L55	6180000790	COIL LAL 03NA 1R5M

[MAIN UNIT]

REF. NO.	ORDER NO.	DESCRIPTION	
L56	6180000790	COIL	LAL 03NA 1R5M
L57	6180000900	COIL	LAL 03NA 101K
L58	6180000780	COIL	LAL 03NA 1R2M
L59	6180000770	COIL	LAL 03NA 1R0M
L60	6180000760	COIL	LAL 03NA R82M
L61	6180000780	COIL	LAL 03NA 1R2M
L62	6180000900	COIL	LAL 03NA 101K
L63	6180000760	COIL	LAL 03NA R82M
L64	6180000750	COIL	LAL 03NA R68M
L65	6180000750	COIL	LAL 03NA R68M
L66	6180000740	COIL	LAL 03NA R56M
L67	6180000900	COIL	LAL 03NA 101K
L68	6180000730	COIL	LAL 03NA R47M
L69	6180000730	COIL	LAL 03NA R47M
L70	6180000730	COIL	LAL 03NA R47M
L71	6180000730	COIL	LAL 03NA R47M
L72	6180000900	COIL	LAL 03NA 101K
L73	6180000700	COIL	LAL 03NA R27M
L74	6180000700	COIL	LAL 03NA R27M
L75	6180000710	COIL	LAL 03NA R33M
L76	6180000710	COIL	LAL 03NA R33M
L77	6150002291	COIL	LS-450
L78	6150002271	COIL	LS-451
L79	6150002291	COIL	LS-450
L80	6170000140	COIL	LW-15
L81	6180000690	COIL	LAL 03NA R22M
L82	6150001220	COIL	LS-134
L83	6150001210	COIL	LS-133A
L85	6180000900	COIL	LAL 03NA 101K
L86	6180000900	COIL	LAL 03NA 101K
L87	6180000900	COIL	LAL 03NA 101K
L88	6180000880	COIL	LAL 03NA 100K
L91	6180000900	COIL	LAL 03NA 101K
L92	6180000900	COIL	LAL 03NA 101K
L93	6910000670	COIL	BT01RN1-A61-001
L94	6180000900	COIL	LAL 03NA 101K
L95	6180000900	COIL	LAL 03NA 101K
L96	6910000670	COIL	BT01RN1-A61-001
L97	6180000900	COIL	LAL 03NA 101K
L98	6910000670	COIL	BT01RN1-A61-001
L99	6180000900	COIL	LAL 03NA 101K
L100	6180000900	COIL	LAL 03NA 101K
L101	6180000900	COIL	LAL 03NA 101K
L102	6910000670	COIL	BT01RN1-A61-001
L103	6180000900	COIL	LAL 03NA 101K
L105	6180000900	COIL	LAL 03NA 101K
L106	6150001210	COIL	LS-133A
L108	6180000920	COIL	LAL 03NA 221K
L115	6180000900	COIL	LAL 03NA 101K
L116	6180000900	COIL	LAL 03NA 101K
L117	6180000900	COIL	LAL 03NA 101K
L118	6180000700	COIL	LAL 03NA R27M
L147	6180000760	COIL	LAL 03NA R82M
L148	6180000900	COIL	LAL 03NA 101K
L149	6180000900	COIL	LAL 03NA 101K
L150	6180002290	COIL	LAL 03NA 330K
L151	6180000900	COIL	LAL 03NA 101K
L152	6910000670	COIL	BT01RN1-A61-001
L153	6180000900	COIL	LAL 03NA 101K
R1	7010003330	RESISTOR	ELR20J 270 Ω
R2	7010003190	RESISTOR	ELR20J 18 Ω
R3	7010003330	RESISTOR	ELR20J 270 Ω
R4	7010003991	RESISTOR	R20 T-24J 22 Ω
R5	7010003520	RESISTOR	ELR20J 8.2 kΩ
R6	7010003130	RESISTOR	ELR20J 5.6 Ω
R7	7010004211	RESISTOR	R20 T-24J 1.5 kΩ
R8	7010003250	RESISTOR	ELR20J 56 Ω
R9	7010003660	RESISTOR	ELR20J 100 kΩ
R10	7010003660	RESISTOR	ELR20J 100 kΩ
R11	7010003530	RESISTOR	ELR20J 10 kΩ
R12	7010003240	RESISTOR	ELR20J 47 Ω
R13	7010003160	RESISTOR	ELR20J 10 Ω
R14	7010004171	RESISTOR	R20 T-24J 680 Ω

[MAIN UNIT]

REF. NO.	ORDER NO.	DESCRIPTION	
R15	7010003490	RESISTOR	ELR20J 5.6 kΩ
R16	7010003260	RESISTOR	ELR20J 68 Ω
R17	7010004071	RESISTOR	R20 T-24J 100 Ω
R18	7010003510	RESISTOR	ELR20J 6.8 kΩ
R19	7010000791	RESISTOR	R25X T-24J 1 Ω
R20	7010003440	RESISTOR	ELR20J 2.2 kΩ
R21	7010003460	RESISTOR	ELR20J 3.3 kΩ
R22	7010004091	RESISTOR	R20 T-24J 150 Ω
R23	7010004271	RESISTOR	R20 T-24J 4.7 kΩ
R24	7010003330	RESISTOR	ELR20J 270 Ω
R25	7010003330	RESISTOR	ELR20J 270 Ω
R26	7010003190	RESISTOR	ELR20J 18 Ω
R27	7010003460	RESISTOR	ELR20J 3.3 kΩ
R28	7010004231	RESISTOR	R20 T-24J 2.2 kΩ
R29	7010004231	RESISTOR	R20 T-24J 2.2 kΩ
R30	7010001191	RESISTOR	R25X T-24J 2.2 kΩ
R31	7010003320	RESISTOR	ELR20J 220 Ω
R32	7010000991	RESISTOR	R25X T-24J 47 Ω
R33	7010004531	RESISTOR	R20 T-24J 470 kΩ
R34	7010003580	RESISTOR	ELR20J 22 kΩ
R36	7010003320	RESISTOR	ELR20J 220 Ω
R37	7010004071	RESISTOR	R20 T-24J 100 Ω
R38	7010003660	RESISTOR	ELR20J 100 kΩ
R39	7010003280	RESISTOR	ELR20J 100 Ω
R40	7010004071	RESISTOR	R20 T-24J 100 Ω
R41	7010003951	RESISTOR	R20 T-24J 10 Ω
R42	7010004271	RESISTOR	R20 T-24J 4.7 kΩ
R43	7010004451	RESISTOR	R20 T-24J 100 kΩ
R45	7010004411	RESISTOR	R20 T-24J 47 kΩ
R46	7010003660	RESISTOR	ELR20J 100 kΩ
R47	7010004321	RESISTOR	R20 T-24J 10 kΩ
R48	7010003510	RESISTOR	ELR20J 6.8 kΩ
R49	7010003340	RESISTOR	ELR20J 330 Ω
R50	7010003580	RESISTOR	ELR20J 22 kΩ
R51	7010004191	RESISTOR	R20 T-24J 1 kΩ
R52	7010001281	RESISTOR	R25X T-24J 10 kΩ
R53	7010004321	RESISTOR	R20 T-24J 10 kΩ
R54	7010004231	RESISTOR	R20 T-24J 2.2 kΩ
R55	7010004231	RESISTOR	R20 T-24J 2.2 kΩ
R56	7010003460	RESISTOR	ELR20J 3.3 kΩ
R57	7010004211	RESISTOR	R20 T-24J 1.5 kΩ
R58	7010004071	RESISTOR	R20 T-24J 100 Ω
R59	7010004231	RESISTOR	R20 T-24J 2.2 kΩ
R60	7010003420	RESISTOR	ELR20J 1.5 kΩ
R61	7010004231	RESISTOR	R20 T-24J 2.2 kΩ
R62	7010003440	RESISTOR	ELR20J 2.2 kΩ
R63	7010001031	RESISTOR	R25X T-24J 100 Ω
R64	7010003440	RESISTOR	ELR20J 2.2 kΩ
R65	7010000330	RESISTOR	ELR25J 470 Ω
R66	7010004111	RESISTOR	R20 T-24J 220 Ω
R67	7010003991	RESISTOR	R20 T-24J 22 Ω
R68	7010003320	RESISTOR	ELR20J 220 Ω
R69	7010003911	RESISTOR	R20 T-24J 4.7 Ω
R70	7010003440	RESISTOR	ELR20J 2.2 kΩ
R71	7010003400	RESISTOR	ELR20J 1 kΩ
R72	7010003400	RESISTOR	ELR20J 1 kΩ
R73	7010003360	RESISTOR	ELR20J 470 Ω
R74	7010003360	RESISTOR	ELR20J 470 Ω
R75	7010003530	RESISTOR	ELR20J 10 kΩ
R76	7010004031	RESISTOR	R20 T-24J 47 Ω
R77	7010003270	RESISTOR	ELR20J 82 Ω
R78	7010004571	RESISTOR	R20 T-24J 1 MΩ
R79	7010003991	RESISTOR	R20 T-24J 22 Ω
R80	7010004111	RESISTOR	R20 T-24J 220 Ω
R81	7010000991	RESISTOR	R25X T-24J 47 Ω
R82	7010003540	RESISTOR	ELR20J 12 kΩ
R83	7010004231	RESISTOR	R20 T-24J 2.2 kΩ
R84	7010004031	RESISTOR	R20 T-24J 47 Ω
R85	7310003200	TRIMMER	EVN-2ACA00 B14 (103)
R86	7010004071	RESISTOR	R20 T-24J 100 Ω
R87	7010004951	RESISTOR	R20 T-24J 1.5 MΩ
R88	7010003360	RESISTOR	ELR20J 470 Ω
R89	7510000300	THERMISTOR	ERT-D2ZGL 601S
R90	7010004321	RESISTOR	R20 T-24J 10 kΩ
R91	7010004031	RESISTOR	R20 T-24J 47 Ω

[MAIN UNIT]

REF. NO.	ORDER NO.	DESCRIPTION
R92	7010004131	RESISTOR R20 T-24J 330 Ω
R93	7010001111	RESISTOR R25X T-24J 470 Ω
R94	7010000330	RESISTOR ELR25J 470 Ω
R95	7010004071	RESISTOR R20 T-24J 100 Ω
R96	7010004071	RESISTOR R20 T-24J 100 Ω
R97	7010004071	RESISTOR R20 T-24J 100 Ω
R98	7010004071	RESISTOR R20 T-24J 100 Ω
R99	7010004071	RESISTOR R20 T-24J 100 Ω
R100	7010004071	RESISTOR R20 T-24J 100 Ω
R101	7410000180	ARRAY RMX- 8 103K
R102	7010003350	RESISTOR ELR20J 390 Ω
R103	7010003250	RESISTOR ELR20J 56 Ω
R104	7010003620	RESISTOR ELR20J 47 kΩ
R105	7010000871	RESISTOR R25X T-24J 4.7 Ω
R106	7010003480	RESISTOR ELR20J 4.7 kΩ
R107	7010003740	RESISTOR ELR20J 470 kΩ
R108	7010004371	RESISTOR R20 T-24J 22 kΩ
R109	7010003630	RESISTOR ELR20J 56 kΩ
R110	7310003180	TRIMMER EVN-2ACA00 B24 (203)
R111	7010003530	RESISTOR ELR20J 10 kΩ
R112	7010001031	RESISTOR R25X T-24J 100 Ω
R113	7010005320	RESISTOR ELR20J 4.7 MΩ
R114	7010004571	RESISTOR R20 T-24J 1 MΩ
R115	7010003750	RESISTOR ELR20J 560 kΩ
R116	7310003710	TRIMMER EVN-2ACA00 B33 (302)
R117	7010003340	RESISTOR ELR20J 330 Ω
R118	7010003820	RESISTOR ELR20J 3.3 MΩ
R119	7010003530	RESISTOR ELR20J 10 kΩ
R120	7010003280	RESISTOR ELR20J 100 Ω
R121	7010003520	RESISTOR ELR20J 8.2 kΩ
R122	7010004191	RESISTOR R20 T-24J 1 kΩ
R123	7010003400	RESISTOR ELR20J 1 kΩ
R124	7010003480	RESISTOR ELR20J 4.7 kΩ
R125	7010003550	RESISTOR ELR20J 15 kΩ
R126	7010003510	RESISTOR ELR20J 6.8 kΩ
R127	7010003640	RESISTOR ELR20J 68 kΩ
R128	7010003660	RESISTOR ELR20J 100 kΩ
R129	7010003400	RESISTOR ELR20J 1 kΩ
R130	7010004151	RESISTOR R20 T-24J 470 Ω
R131	7010003700	RESISTOR ELR20J 220 kΩ
R132	7010003550	RESISTOR ELR20J 15 kΩ
R133	7010003400	RESISTOR ELR20J 1 kΩ
R134	7010003460	RESISTOR ELR20J 3.3 kΩ
R135	7010003240	RESISTOR ELR20J 47 Ω
R136	7010004031	RESISTOR R20 T-24J 47 Ω
R137	7010004071	RESISTOR R20 T-24J 100 Ω
R138	7310003210	TRIMMER EVN-2ACA00 B54 (503)
R139	7010003640	RESISTOR ELR20J 68 kΩ
R141	7010004071	RESISTOR R20 T-24J 100 Ω
R142	7010003340	RESISTOR ELR20J 330 Ω
R143	7010004151	RESISTOR R20 T-24J 470 Ω
R144	7010004321	RESISTOR R20 T-24J 10 kΩ
R145	7010004071	RESISTOR R20 T-24J 100 Ω
R146	7010004231	RESISTOR R20 T-24J 2.2 kΩ
R147	7010003440	RESISTOR ELR20J 2.2 kΩ
R148	7010003530	RESISTOR ELR20J 10 kΩ
R149	7010003040	RESISTOR ELR20J 1 Ω
R150	7010003100	RESISTOR ELR20J 3.3 Ω
R151	7010003400	RESISTOR ELR20J 1 kΩ
R152	7010003530	RESISTOR ELR20J 10 kΩ
R153	7010004321	RESISTOR R20 T-24J 10 kΩ
R154	7010003530	RESISTOR ELR20J 10 kΩ
R155	7010004321	RESISTOR R20 T-24J 10 kΩ
R156	7010004191	RESISTOR R20 T-24J 1 kΩ
R157	7010003480	RESISTOR ELR20J 4.7 kΩ
R158	7010004191	RESISTOR R20 T-24J 1 kΩ
R160	7010001261	RESISTOR R25X T-24J 6.8 kΩ
R165	7010004071	RESISTOR R20 T-24J 100 Ω
R166	7010003660	RESISTOR ELR20J 100 kΩ
R167	7010004451	RESISTOR R20 T-24J 100 kΩ
R168	7010003660	RESISTOR ELR20J 100 kΩ
R169	7010003440	RESISTOR ELR20J 2.2 kΩ
R170	7010004231	RESISTOR R20 T-24J 2.2 kΩ
R171	7010003440	RESISTOR ELR20J 2.2 kΩ
R172	7010004231	RESISTOR R20 T-24J 2.2 kΩ

[MAIN UNIT]

REF. NO.	ORDER NO.	DESCRIPTION
R173	7010003480	RESISTOR ELR20J 4.7 kΩ
R174	7010003470	RESISTOR ELR20J 3.9 kΩ
R175	7010003420	RESISTOR ELR20J 1.5 kΩ
R176	7010004451	RESISTOR R20 T-24J 100 kΩ
R177	7310003200	TRIMMER EVN-2ACA00 B14 (103)
R178	7010003660	RESISTOR ELR20J 100 kΩ
R179	7310003200	TRIMMER EVN-2ACA00 B14 (103)
R180	7010004491	RESISTOR R20 T-24J 220 kΩ
R181	7010004231	RESISTOR R20 T-24J 2.2 kΩ
R182	7010003480	RESISTOR ELR20J 4.7 kΩ
R183	7010003530	RESISTOR ELR20J 10 kΩ
R184	7010004231	RESISTOR R20 T-24J 2.2 kΩ
R185	7010003710	RESISTOR ELR20J 270 kΩ
R186	7310003230	TRIMMER EVN-2ACA00 B15 (104)
R187	7010003620	RESISTOR ELR20J 47 kΩ
R188	7010003620	RESISTOR ELR20J 47 kΩ
R189	7010003530	RESISTOR ELR20J 10 kΩ
R191	7010003620	RESISTOR ELR20J 47 kΩ
R192	7010003620	RESISTOR ELR20J 47 kΩ
R193	7010003600	RESISTOR ELR20J 33 kΩ
R194	7310003200	TRIMMER EVN-2ACA00 B14 (103)
R195	7010004391	RESISTOR R20 T-24J 33 kΩ
R196	7010003780	RESISTOR ELR20J 1 MΩ
R197	7010003360	RESISTOR ELR20J 470 Ω
R198	7010004571	RESISTOR R20 T-24J 1 MΩ
R199	7010005220	RESISTOR ELR20J 10 MΩ
R200	7010003780	RESISTOR ELR20J 1 MΩ
R201	7010004271	RESISTOR R20 T-24J 4.7 kΩ
R202	7010003360	RESISTOR ELR20J 470 Ω
R203	7010004481	RESISTOR R20 T-24J 180 kΩ
R204	7010003670	RESISTOR ELR20J 120 kΩ
R205	7010003360	RESISTOR ELR20J 470 Ω
R206	7010003680	RESISTOR ELR20J 150 kΩ
R207	7010003510	RESISTOR ELR20J 6.8 kΩ
R208	7310000740	TRIMMER RH0651CS3J2KA (472)
R209	7010003580	RESISTOR ELR20J 22 kΩ
R210	7310000780	TRIMMER RH0651CS4J25A (473)
R211	7010001491	RESISTOR R25X T-24J 470 kΩ
R212	7010003480	RESISTOR ELR20J 4.7 kΩ
R213	7010003810	RESISTOR ELR20J 2.2 MΩ
R214	7010003360	RESISTOR ELR20J 470 Ω
R215	7010003300	RESISTOR ELR20J 150 Ω
R216	7010003530	RESISTOR ELR20J 10 kΩ
R217	7010003660	RESISTOR ELR20J 100 kΩ
R220	7010003740	RESISTOR ELR20J 470 kΩ
R221	7010003740	RESISTOR ELR20J 470 kΩ
R222	7010003530	RESISTOR ELR20J 10 kΩ
R223	7010001031	RESISTOR R25X T-24J 100 Ω
R224	7010003530	RESISTOR ELR20J 10 kΩ
R225	7010000090	RESISTOR ELR25J 4.7 Ω
R226	7010000370	RESISTOR ELR25J 1 kΩ
R227	7010000090	RESISTOR ELR25J 4.7 Ω
R228	7010000370	RESISTOR ELR25J 1 kΩ
R229	7010000090	RESISTOR ELR25J 4.7 Ω
R230	7010003400	RESISTOR ELR20J 1 kΩ
R232	7010004111	RESISTOR R20 T-24J 220 Ω
R233	7010003480	RESISTOR ELR20J 4.7 kΩ
R234	7010003480	RESISTOR ELR20J 4.7 kΩ
R235	7010003490	RESISTOR ELR20J 5.6 kΩ
R236	7010004311	RESISTOR R20 T-24J 8.2 kΩ
R237	7010003380	RESISTOR ELR20J 680 Ω
R238	7310000860	TRIMMER RH1051D13J0JA (1KB)
R239	7010003540	RESISTOR ELR20J 12 kΩ
R240	7010003440	RESISTOR ELR20J 2.2 kΩ
R241	7310003200	TRIMMER EVN-2ACA00 B14 (103)
R242	7010003530	RESISTOR ELR20J 10 kΩ
R243	7010003280	RESISTOR ELR20J 100 Ω
R244	7210001540	VARIABLE RK09K1110AEFA (1MB) [DELAY]
R245	7010004321	RESISTOR R20 T-24J 10 kΩ
R246	7010003400	RESISTOR ELR20J 1 kΩ
R247	7010001260	RESISTOR R25XJ 6.8 kΩ
R248	7010004571	RESISTOR R20 T-24J 1 MΩ
R249	7010001031	RESISTOR R25X T-24J 100 Ω
R256	7010004271	RESISTOR R20 T-24J 4.7 kΩ

[MAIN UNIT]

REF. NO.	ORDER NO.	DESCRIPTION
R257	7010004271	RESISTOR R20 T-24J 4.7 kΩ
R258	7010004411	RESISTOR R20 T-24J 47 kΩ
R259	7010003250	RESISTOR ELR20J 56 Ω
R260	7010003400	RESISTOR ELR20J 1 kΩ
R263	7010004231	RESISTOR R20 T-24J 2.2 kΩ
R264	7010003580	RESISTOR ELR20J 22 kΩ
R265	7010003530	RESISTOR ELR20J 10 kΩ
R266	7010004191	RESISTOR R20 T-24J 1 kΩ
R267	7010004271	RESISTOR R20 T-24J 4.7 kΩ
R268	7010003360	RESISTOR ELR20J 470 Ω
R269	7010003120	RESISTOR ELR20J 4.7 Ω
R270	7010004321	RESISTOR R20 T-24J 10 kΩ
R271	7010004321	RESISTOR R20 T-24J 10 kΩ
R272	7010004171	RESISTOR R20 T-24J 680 Ω
R274	7010004321	RESISTOR R20 T-24J 10 kΩ
R275	7010003530	RESISTOR ELR20J 10 kΩ
R276	7010001111	RESISTOR R25X T-24J 470 Ω
R277	7010004371	RESISTOR R20 T-24J 22 kΩ
R278	7010004071	RESISTOR R20 T-24J 100 Ω
R279	7010001401	RESISTOR R25X T-24J 100 kΩ
R280	7010004451	RESISTOR R20 T-24J 100 kΩ
R281	7010004371	RESISTOR R20 T-24J 22 kΩ
R282	7010004321	RESISTOR R20 T-24J 10 kΩ
R283	7010003420	RESISTOR ELR20J 1.5 kΩ
R284	7010003530	RESISTOR ELR20J 10 kΩ
R285	7010003620	RESISTOR ELR20J 47 kΩ
R286	7010001150	RESISTOR R25XJ 1 kΩ
R287	7010003530	RESISTOR ELR20J 10 kΩ
R288	7010004191	RESISTOR R20 T-24J 1 kΩ
R289	7010004071	RESISTOR R20 T-24J 100 Ω
R290	7010003280	RESISTOR ELR20J 100 Ω
R291	7010003440	RESISTOR ELR20J 2.2 kΩ
R292	7010003490	RESISTOR ELR20J 5.6 kΩ
R293	7010001111	RESISTOR R25X T-24J 470 Ω
R295	7010004321	RESISTOR R20 T-24J 10 kΩ
R296	7010001281	RESISTOR R25X T-24J 10 kΩ
R297	7010003660	RESISTOR ELR20J 100 kΩ
R298	7010003530	RESISTOR ELR20J 10 kΩ
R299	7010001281	RESISTOR R25X T-24J 10 kΩ
R300	7010003480	RESISTOR ELR20J 4.7 kΩ
R302	7010003420	RESISTOR ELR20J 1.5 kΩ
R304	7310003280	TRIMMER EVN-2ACA00 B25 (204)
R306	7010004271	RESISTOR R20 T-24J 4.7 kΩ
R307	7310003200	TRIMMER EVN-2ACA00 B14 (103)
R308	7010004521	RESISTOR R20 T-24J 390 kΩ
R309	7010003600	RESISTOR ELR20J 33 kΩ
R311	7010003480	RESISTOR ELR20J 4.7 kΩ
R312	7010004031	RESISTOR R20 T-24J 47 Ω
R313	7010003360	RESISTOR ELR20J 470 Ω
R314	7010003420	RESISTOR ELR20J 1.5 kΩ
R315	7510000320	THERMISTOR ERT-D2ZGL 202S
R316	7010003470	RESISTOR ELR20J 3.9 kΩ
R317	7010000010	RESISTOR ELR25J 1 Ω
R318	7010004301	RESISTOR R20 T-24J 6.8 kΩ
R319	7010001191	RESISTOR R25X T-24J 2.2 kΩ
R320	7010003530	RESISTOR ELR20J 10 kΩ
R321	7310003210	TRIMMER EVN-2ACA00 B54 (503)
R322	7010003480	RESISTOR ELR20J 4.7 kΩ
R323	7010001111	RESISTOR R25X T-24J 470 Ω
R324	7010004301	RESISTOR R20 T-24J 6.8 kΩ
R325	7010001071	RESISTOR R25X T-24J 220 Ω
R326	7010001261	RESISTOR R25X T-24J 6.8 kΩ
R327	7010004151	RESISTOR R20 T-24J 470 Ω
R328	7010003280	RESISTOR ELR20J 100 Ω
R329	7010004321	RESISTOR R20 T-24J 10 kΩ
R330	7010003530	RESISTOR ELR20J 10 kΩ
R331	7010004071	RESISTOR R20 T-24J 100 Ω
R332	7010004271	RESISTOR R20 T-24J 4.7 kΩ
R333	7010004281	RESISTOR R20 T-24 5.6 kΩ
R334	7010004411	RESISTOR R20 T-24J 47 kΩ
R335	7010004411	RESISTOR R20 T-24J 47 kΩ
R336	7010004191	RESISTOR R20 T-24J 1 kΩ
R337	7010004271	RESISTOR R20 T-24J 4.7 kΩ
R415	7010003180	RESISTOR ELR20J 15 Ω
R416	7010004321	RESISTOR R20 T-24J 10 kΩ

[MAIN UNIT]

REF. NO.	ORDER NO.	DESCRIPTION
R417	7510000071	THERMISTOR ERT-D2ZHL 503S
R418	7010003360	RESISTOR ELR20J 470 Ω
R419	7510000590	THERMISTOR ERT-D2ZGL 101S
R420	7010003480	RESISTOR ELR20J 4.7 kΩ
R421	7010004111	RESISTOR R20 T-24J 220 Ω
R422	7010003670	RESISTOR ELR20J 120 kΩ
R423	7010003530	RESISTOR ELR20J 10 kΩ
R424	7010003530	RESISTOR ELR20J 10 kΩ
R425	7010004251	RESISTOR R20 T-24J 3.3 kΩ
R426	7010004051	RESISTOR R20 T-24J 68 Ω
R427	7010004191	RESISTOR R20 T-24J 1 kΩ
R428	7010003620	RESISTOR ELR20J 47 kΩ
R429	7010003620	RESISTOR ELR20J 47 kΩ
R430	7010003400	RESISTOR ELR20J 1 kΩ
R431	7010003440	RESISTOR ELR20J 2.2 kΩ
R432	7010003610	RESISTOR ELR20J 39 kΩ
R433	7010003560	RESISTOR ELR20J 18 kΩ
R434	7010000791	RESISTOR R25X T-24J 1 Ω
C1	4010000520	CERAMIC DD108 B 472K 50V
C2	4040000260	BARRIER UZE 08X 104M
C4	4010000270	CERAMIC DD104 SL 510J 50V
C5	4010000340	CERAMIC DD105 SL 121J 50V
C6	4010000160	CERAMIC DD104 SL 180J 50V
C7	4010000280	CERAMIC DD104 SL 560J 50V
C8	4040000110	BARRIER UAT 04X 222K
C9	4010004840	CERAMIC DD305 F 104Z 12V
C10	4040000130	BARRIER UAT 05X 332K
C11	4010000070	CERAMIC DD104 SL 050C 50V
C12	4020000730	CYLINDER UP050 SL 150J
C13	4010000340	CERAMIC DD105 SL 121J 50V
C14	4010000520	CERAMIC DD108 B 472K 50V
C15	4010000520	CERAMIC DD108 B 472K 50V
C16	4010000020	CERAMIC DD104 SL 010C 50V
C17	4010000120	CERAMIC DD104 SL 100D 50V
C18	4010000100	CERAMIC DD104 SL 080D 50V
C19	4010000020	CERAMIC DD104 SL 010C 50V
C20	4010000500	CERAMIC DD104 B 102K 50V
C21	4010000330	CERAMIC DD105 SL 101J 50V
C23	4010000240	CERAMIC DD104 SL 390J 50V
C25	4010000500	CERAMIC DD104 B 102K 50V
C26	4010000100	CERAMIC DD104 SL 080D 50V
C27	4040000150	BARRIER UAT 05X 472K
C28	4010000520	CERAMIC DD108 B 472K 50V
C29	4010000500	CERAMIC DD104 B 102K 50V
C30	4010000520	CERAMIC DD108 B 472K 50V
C31	4010000100	CERAMIC DD104 SL 080D 50V
C32	4010000100	CERAMIC DD104 SL 080D 50V
C33	4010000300	CERAMIC DD104 SL 680J 50V
C35	4010000520	CERAMIC DD108 B 472K 50V
C36	4040000150	BARRIER UAT 05X 472K
C37	4010000340	CERAMIC DD105 SL 121J 50V
C38	4020000030	CYLINDER UP125 SL 2R2K
C39	4010000070	CERAMIC DD104 SL 050C 50V
C40	4010004840	CERAMIC DD305 F 104Z 12V
C42	4040000260	BARRIER UZE 08X 104M
C43	4010000520	CERAMIC DD108 B 472K 50V
C44	4010000520	CERAMIC DD108 B 472K 50V
C46	4010000520	CERAMIC DD108 B 472K 50V
C47	4020000910	CYLINDER UP125 SL 270J
C49	4010000520	CERAMIC DD108 B 472K 50V
C50	4010000520	CERAMIC DD108 B 472K 50V
C51	4510003790	ELECTROLYTIC 16 MV 10 SW
C52	4010000520	CERAMIC DD108 B 472K 50V
C53	4010000520	CERAMIC DD108 B 472K 50V
C56	4010000520	CERAMIC DD108 B 472K 50V
C58	4010000340	CERAMIC DD105 SL 121J 50V
C59	4010000180	CERAMIC DD104 SL 220J 50V
C60	4510003790	ELECTROLYTIC 16 MV 10 SW
C61	4510003910	ELECTROLYTIC 16 MV 47 HW
C62	4040000260	BARRIER UZE 08X 104M
C64	4010000520	CERAMIC DD108 B 472K 50V
C65	4010000520	CERAMIC DD108 B 472K 50V
C66	4010004840	CERAMIC DD305 F 104Z 12V

[MAIN UNIT]

REF. NO.	ORDER NO.	DESCRIPTION
C67	4040000150	BARRIER UAT 05X 472K
C68	4040000150	BARRIER UAT 05X 472K
C69	4010004840	CERAMIC DD305 F 104Z 12V
C70	4040000250	BARRIER UAT 08X 473M
C71	4040000250	BARRIER UAT 08X 473M
C72	4010000330	CERAMIC DD105 SL 101J 50V
C73	4040000250	BARRIER UAT 08X 473M
C74	4040000250	BARRIER UAT 08X 473M
C75	4040000250	BARRIER UAT 08X 473M
C78	4010000350	CERAMIC DD106 SL 151J 50V
C79	4010000120	CERAMIC DD104 SL 100D 50V
C80	4010000320	CERAMIC DD104 SL 820J 50V
C81	4040000260	BARRIER UZE 08X 104M
C82	4010000120	CERAMIC DD104 SL 100D 50V
C83	4010004840	CERAMIC DD305 F 104Z 12V
C84	4010004840	CERAMIC DD305 F 104Z 12V
C85	4010000500	CERAMIC DD104 B 102K 50V
C86	4040000260	BARRIER UZE 08X 104M
C87	4010000100	CERAMIC DD104 SL 080D 50V
C89	4010000100	CERAMIC DD104 SL 080D 50V
C90	4010000100	CERAMIC DD104 SL 080D 50V
C91	4040000260	BARRIER UZE 08X 104M
C92	4010000520	CERAMIC DD108 B 472K 50V
C93	4010000080	CERAMIC DD104 SL 060D 50V
C94	4010000520	CERAMIC DD108 B 472K 50V
C95	4510003830	ELECTROLYTIC 50 MV R47 SW
C96	4010000520	CERAMIC DD108 B 472K 50V
C97	4510003860	ELECTROLYTIC 50 MV 3R3 SW
C99	4010000520	CERAMIC DD108 B 472K 50V
C100	4510003910	ELECTROLYTIC 16 MV 47 HW
C101	4040000260	BARRIER UZE 08X 104M
C102	4010000500	CERAMIC DD104 B 102K 50V
C109	4510003790	ELECTROLYTIC 16 MV 10 SW
C110	4310000400	MYLER 50 F2D 223J
C111	4510005240	ELECTROLYTIC 16 MV 22 SWB
C112	4510003790	ELECTROLYTIC 16 MV 10 SW
C113	4510003830	ELECTROLYTIC 50 MV R47 SW
C114	4040000150	BARRIER UAT 05X 472K
C115	4510003910	ELECTROLYTIC 16 MV 47 HW
C116	4010000330	CERAMIC DD105 SL 101J 50V
C117	4010000350	CERAMIC DD106 SL 151J 50V
C118	4040000150	BARRIER UAT 05X 472K
C119	4010000520	CERAMIC DD108 B 472K 50V
C120	4010004840	CERAMIC DD305 F 104Z 12V
C121	4010000520	CERAMIC DD108 B 472K 50V
C122	4040000390	BARRIER UAT 06V 103K
C123	4010000380	CERAMIC DD107 SL 221J 50V
C124	4510003840	ELECTROLYTIC 50 MV 1 SW
C125	4040000260	BARRIER UZE 08X 104M
C126	4010004840	CERAMIC DD305 F 104Z 12V
C127	4010004840	CERAMIC DD305 F 104Z 12V
C129	4010000340	CERAMIC DD105 SL 121J 50V
C130	4010004840	CERAMIC DD305 F 104Z 12V
C132	4010000520	CERAMIC DD108 B 472K 50V
C133	4010004840	CERAMIC DD305 F 104Z 12V
C135	4040000260	BARRIER UZE 08X 104M
C136	4310000400	MYLER 50 F2D 223J
C137	4010000160	CERAMIC DD104 SL 180J 50V
C138	4010000520	CERAMIC DD108 B 472K 50V
C139	4040000250	BARRIER UAT 08X 473M
C140	4010000520	CERAMIC DD108 B 472K 50V
C141	4010000520	CERAMIC DD108 B 472K 50V
C142	4010000080	CERAMIC DD104 SL 060D 50V
C143	4040000090	BARRIER UAT 04X 152K
C144	4040000130	BARRIER UAT 05X 332K
C145	4040000460	BARRIER RAU 08SA 821K
C146	4040000180	BARRIER UAT 05X 822K
C147	4040000130	BARRIER UAT 05X 332K
C148	4040000070	BARRIER UAT 04X 102K
C149	4020000630	CYLINDER UP050 B 101K
C150	4040000070	BARRIER UAT 04X 102K
C151	4040000250	BARRIER UAT 08X 473M
C152	4040000260	BARRIER UZE 08X 104M
C153	4040000260	BARRIER UZE 08X 104M
C154	4010000520	CERAMIC DD108 B 472K 50V

[MAIN UNIT]

REF. NO.	ORDER NO.	DESCRIPTION
C155	4040000100	BARRIER UAT 04X 182K
C156	4040000100	BARRIER UAT 04X 182K
C157	4010000410	CERAMIC DD107 SL 331J 50V
C158	4040000260	BARRIER UZE 08X 104M
C159	4040000080	BARRIER UAT 04X 122K
C160	4010000330	CERAMIC DD105 SL 101J 50V
C161	4040000080	BARRIER UAT 04X 122K
C162	4040000170	BARRIER UAT 05X 682K
C163	4040000180	BARRIER UAT 05X 822K
C164	4040000080	BARRIER UAT 04X 122K
C165	4040000250	BARRIER UAT 08X 473M
C166	4040000260	BARRIER UZE 08X 104M
C167	4010000440	CERAMIC DD109 SL 511J 50V
C168	4010000330	CERAMIC DD105 SL 101J 50V
C169	4010000430	CERAMIC DD109 SL 471J 50V
C170	4040000080	BARRIER UAT 04X 122K
C171	4040000160	BARRIER UAT 05X 822K
C172	4040000440	BARRIER RAU 06SA 561K
C173	4040000250	BARRIER UAT 08X 473M
C174	4040000260	BARRIER UZE 08X 104M
C175	4010000410	CERAMIC DD107 SL 331J 50V
C176	4010000270	CERAMIC DD104 SL 510J 50V
C177	4010000410	CERAMIC DD107 SL 331J 50V
C178	4010000410	CERAMIC DD107 SL 331J 50V
C179	4040000120	BARRIER UAT 05X 272K
C180	4010000410	CERAMIC DD107 SL 331J 50V
C181	4040000250	BARRIER UAT 08X 473M
C182	4040000260	BARRIER UZE 08X 104M
C183	4010000410	CERAMIC DD107 SL 331J 50V
C184	4010000260	CERAMIC DD104 SL 470J 50V
C185	4010000380	CERAMIC DD107 SL 221J 50V
C186	4010000380	CERAMIC DD107 SL 221J 50V
C187	4040000100	BARRIER UAT 04X 182K
C188	4010000370	CERAMIC DD106 SL 201J 50V
C189	4040000250	BARRIER UAT 08X 473M
C190	4040000260	BARRIER UZE 08X 104M
C191	4010000380	CERAMIC DD107 SL 221J 50V
C192	4010000160	CERAMIC DD104 SL 180J 50V
C193	4010000330	CERAMIC DD105 SL 101J 50V
C194	4010000380	CERAMIC DD107 SL 221J 50V
C195	4040000080	BARRIER UAT 04X 122K
C196	4010000350	CERAMIC DD106 SL 151J 50V
C197	4040000250	BARRIER UAT 08X 473M
C198	4040000260	BARRIER UZE 08X 104M
C199	4010000220	CERAMIC DD104 SL 330J 50V
C200	4010000340	CERAMIC DD105 SL 121J 50V
C201	4010000240	CERAMIC DD104 SL 390J 50V
C202	4010000300	CERAMIC DD104 SL 680J 50V
C203	4010000340	CERAMIC DD105 SL 121J 50V
C204	4040000460	BARRIER RAU 08SA 821K
C205	4010000330	CERAMIC DD105 SL 101J 50V
C206	4040000250	BARRIER UAT 08X 473M
C207	4010000520	CERAMIC DD108 B 472K 50V
C208	4530000350	ARRAY B8ZC0111-32N
C209	4010000520	CERAMIC DD108 B 472K 50V
C210	4510004590	ELECTROLYTIC 16 MV 470 HC
C211	4040000260	BARRIER UZE 08X 104M
C212	4510004990	ELECTROLYTIC 16 MV 100 HC
C213	4510004600	ELECTROLYTIC 16 MV 1000 HC
C214	4510004990	ELECTROLYTIC 16 MV 100 HC
C215	4510005000	ELECTROLYTIC 16 MV 220 HC
C216	4040000250	BARRIER UAT 08X 473M
C217	4510003820	ELECTROLYTIC 50 MV R22 SW
C218	4510004990	ELECTROLYTIC 16 MV 100 HC
C219	4040000110	BARRIER UAT 04X 222K
C220	4310000400	MYLER 50 F2D 223J
C221	4510003820	ELECTROLYTIC 50 MV R22 SW
C222	4510003910	ELECTROLYTIC 16 MV 47 HW
C223	4510003820	ELECTROLYTIC 50 MV R22 SW
C226	4040000210	BARRIER UAT 06X 153K
C228	4010000520	CERAMIC DD108 B 472K 50V
C229	4040000150	BARRIER UAT 05X 472K
C230	4010000840	CERAMIC DD105 CH 390J 50V
C231	4010001020	CERAMIC DD111 CH 221J 50V
C232	4010001020	CERAMIC DD111 CH 221J 50V

[MAIN UNIT]

REF. NO.	ORDER NO.	DESCRIPTION
C233	4010000520	CERAMIC DD108 B 472K 50V
C234	4010000520	CERAMIC DD108 B 472K 50V
C235	4010000520	CERAMIC DD108 B 472K 50V
C236	4010004840	CERAMIC DD305 F 104Z 12V
C237	4010000180	CERAMIC DD104 SL 220J 50V
C238	4040000150	BARRIER UAT 05X 472K
C239	4040000150	BARRIER UAT 05X 472K
C240	4010000520	CERAMIC DD108 B 472K 50V
C241	4010000180	CERAMIC DD104 SL 220J 50V
C242	4310000400	MYLER 50 F2D 223J
C243	4310000400	MYLER 50 F2D 223J
C244	4310000400	MYLER 50 F2D 223J
C245	4040000250	BARRIER UAT 08X 473M
C246	4550002120	TANTALUM DN 1C 220M
C247	4040000150	BARRIER UAT 05X 472K
C248	4510003910	ELECTROLYTIC 16 MV 47 HW
C249	4510003840	ELECTROLYTIC 50 MV 1 SW
C250	4510003840	ELECTROLYTIC 50 MV 1 SW
C251	4510003830	ELECTROLYTIC 50 MV R47 SW
C252	4510003840	ELECTROLYTIC 50 MV 1 SW
C253	4010000520	CERAMIC DD108 B 472K 50V
C254	4010000520	CERAMIC DD108 B 472K 50V
C255	4010000520	CERAMIC DD108 B 472K 50V
C256	4010000520	CERAMIC DD108 B 472K 50V
C257	4010000520	CERAMIC DD108 B 472K 50V
C258	4010000330	CERAMIC DD105 SL 101J 50V
C259	4010000520	CERAMIC DD108 B 472K 50V
C260	4010004840	CERAMIC DD305 F 104Z 12V
C261	4510005540	ELECTROLYTIC 10 MV 33 SWB
C262	4040000250	BARRIER UAT 08X 473M
C263	4010000500	CERAMIC DD104 B 102K 50V
C264	4510003840	ELECTROLYTIC 50 MV 1 SW
C265	4040000190	BARRIER UAT 05X 103K
C266	4040000190	BARRIER UAT 05X 103K
C267	4510003830	ELECTROLYTIC 50 MV R47 SW
C268	4510003830	ELECTROLYTIC 50 MV R47 SW
C269	4510003910	ELECTROLYTIC 16 MV 47 HW
C270	4040000260	BARRIER UZE 08X 104M
C271	4510003910	ELECTROLYTIC 16 MV 47 HW
C274	4010000460	CERAMIC DD104 B 471K 50V
C279	4040000150	BARRIER UAT 05X 472K
C280	4040000150	BARRIER UAT 05X 472K
C281	4020000670	CYLINDER UP050 SL 470J
C283	4510003840	ELECTROLYTIC 50 MV 1 SW
C284	4010000520	CERAMIC DD108 B 472K 50V
C285	4010000520	CERAMIC DD108 B 472K 50V
C286	4010000520	CERAMIC DD108 B 472K 50V
C287	4010000520	CERAMIC DD108 B 472K 50V
C288	4010000520	CERAMIC DD108 B 472K 50V
C289	4010000520	CERAMIC DD108 B 472K 50V
C290	4010000520	CERAMIC DD108 B 472K 50V
C291	4010000460	CERAMIC DD104 B 471K 50V
C292	4010000520	CERAMIC DD108 B 472K 50V
C293	4310000400	MYLER 50 F2D 223J
C294	4610001200	TRIMMER CVSSE3001
C295	4010000500	CERAMIC DD104 B 102K 50V
C296	4010000520	CERAMIC DD108 B 472K 50V
C297	4040000250	BARRIER UAT 08X 473M
C298	4010004840	CERAMIC DD305 F 104Z 12V
C299	4040000260	BARRIER UZE 08X 104M
C301	4040000150	BARRIER UAT 05X 472K
C302	4010000520	CERAMIC DD108 B 472K 50V
C303	4010000940	CERAMIC DD107 CH 101J 50V
C304	4010004840	CERAMIC DD305 F 104Z 12V
C305	4010000940	CERAMIC DD107 CH 101J 50V
C306	4010000060	CERAMIC DD104 SL 040C 50V
C307	4010000350	CERAMIC DD106 SL 151J 50V
C308	4010000520	CERAMIC DD108 B 472K 50V
C309	4010004840	CERAMIC DD305 F 104Z 12V
C310	4010004840	CERAMIC DD305 F 104Z 12V
C311	4010004840	CERAMIC DD305 F 104Z 12V
C312	4040000440	BARRIER RAU 06SA 561K
C314	4010004840	CERAMIC DD305 F 104Z 12V
C315	4010004840	CERAMIC DD305 F 104Z 12V
C316	4010000350	CERAMIC DD106 SL 151J 50V

[MAIN UNIT]

REF. NO.	ORDER NO.	DESCRIPTION
C317	4020000340	CYLINDER UP125 B 151K
C318	4010004840	CERAMIC DD305 F 104Z 12V
C319	4010000500	CERAMIC DD104 B 102K 50V
C320	4010000500	CERAMIC DD104 B 102K 50V
C321	4010000520	CERAMIC DD108 B 472K 50V
C323	4040000260	BARRIER UZE 08X 104M
C324	4010000500	CERAMIC DD104 B 102K 50V
C325	4010000520	CERAMIC DD108 B 472K 50V
C327	4010000500	CERAMIC DD104 B 102K 50V
C328	4010000500	CERAMIC DD104 B 102K 50V
C329	4010000500	CERAMIC DD104 B 102K 50V
C330	4040000150	BARRIER UAT 05X 472K
C331	4010000520	CERAMIC DD108 B 472K 50V
C332	4010000330	CERAMIC DD105 SL 101J 50V
C333	4010000520	CERAMIC DD108 B 472K 50V
C334	4040000260	BARRIER UZE 08X 104M
C335	4010004840	CERAMIC DD305 F 104Z 12V
C336	4010004840	CERAMIC DD305 F 104Z 12V
C337	4510004990	ELECTROLYTIC 16 MV 100 HC
C338	4510004990	ELECTROLYTIC 16 MV 100 HC
C339	4010000520	CERAMIC DD108 B 472K 50V
C340	4010000520	CERAMIC DD108 B 472K 50V
C341	4010000520	CERAMIC DD108 B 472K 50V
C342	4010000520	CERAMIC DD108 B 472K 50V
C343	4010000520	CERAMIC DD108 B 472K 50V
C406	4040000150	BARRIER UAT 05X 472K
C410	4040000150	BARRIER UAT 05X 472K
C412	4040000260	BARRIER UZE 08X 104M
C413	4040000260	BARRIER UZE 08X 104M
C414	4010004840	CERAMIC DD305 F 104Z 12V
C415	4010000260	CERAMIC DD104 SL 470J 50V
C417	4010000040	CERAMIC DD104 SL 020C 50V
C418	4510003830	ELECTROLYTIC 50 MV R47 SW
C419	4040000190	BARRIER UAT 05X 103K
C420	4040000250	BARRIER UAT 08X 473M
C421	4040000260	BARRIER UZE 08X 104M
S2	2230000700	SWITCH SPPJ31309A [ELEKEY]
S3	2220000360	SWITCH ESD-1111212
S4	2220000360	SWITCH ESD-1111212
S5	2220000360	SWITCH ESD-1111212
RL1	6330000180	RELAY MZ-12HG
RL2	6330000560	RELAY OUC-SH-114D
J1	6510003460	CONNECTOR B10B-EH-S
J2	6510003410	CONNECTOR B05B-EH-S
J3	6510003450	CONNECTOR B09B-EH-S
J4	6510003250	CONNECTOR TMP-J01X-A2
J5	6510003250	CONNECTOR TMP-J01X-A2
J6	6510003430	CONNECTOR B07B-EH-S
J7	6510003410	CONNECTOR B05B-EH-S
J8	6510003420	CONNECTOR B06B-EH-S
J9	6510003430	CONNECTOR B07B-EH-S
J10	6510003450	CONNECTOR B09B-EH-S
J11	6510003250	CONNECTOR TMP-J01X-A2
J12	6510003250	CONNECTOR TMP-J01X-A2
J13	6510003390	CONNECTOR B03B-EH-S
J14	6450000140	CONNECTOR HSJ0807-01-010 [EXT SP]
J15	6450001260	CONNECTOR HLJ4306-01-3080 [KEY]
J16	6450000150	CONNECTOR JPJ2545-01-510 [SEND]
J17	6450000150	CONNECTOR JPJ2545-01-510 [ALC]
J18	6450000160	CONNECTOR TCS4470-01-1111 [ACC(2)]
J19	6450000170	CONNECTOR TCS4480-01-1111 [ACC(1)]
J20	6510001110	CONNECTOR 3024-10CH
J21	6510003390	CONNECTOR B03B-EH-S
J22	6510003390	CONNECTOR B03B-EH-S
J24	6510013780	CONNECTOR PDK-2081-65
J25	6510013780	CONNECTOR PDK-2081-65
J26	6510003430	CONNECTOR B07B-EH-S
J32	6510003390	CONNECTOR B03B-EH-S
J33	6510006790	CONNECTOR TSL-P03P-V2

[MAIN UNIT]

REF. NO.	ORDER NO.	DESCRIPTION	
J34	6510003430	CONNECTOR	B07B-EH-S
J35	6510003430	CONNECTOR	B07B-EH-S
EP1	0910037325	PCB	B 3663E (MAIN)

[FMAM UNIT]

REF. NO.	ORDER NO.	DESCRIPTION	
IC1	1110000630	IC	MC3357 P
IC2	1110001310	IC	μPC577HA
IC3	1110000250	IC	BA401
IC4	1110001320	IC	μPC1037HA
IC5	1110002500	IC	M5218AL
Q1	1530000591	TRANSISTOR	2SC2785 EL
Q2	1590000340	TRANSISTOR	RN1202
Q3	1590000340	TRANSISTOR	RN1202
Q4	1510000080	TRANSISTOR	2SA1048-GR
Q5	1590000340	TRANSISTOR	RN1202
Q6	1590000360	TRANSISTOR	RN2202
Q7	1590000340	TRANSISTOR	RN1202
Q8	1590000340	TRANSISTOR	RN1202
Q9	1590000360	TRANSISTOR	RN2202
Q10	1590000340	TRANSISTOR	RN1202
Q11	1530000110	TRANSISTOR	2SC2458-GR
Q12	1590000360	TRANSISTOR	RN2202
Q13	1530000110	TRANSISTOR	2SC2458-GR
D1	1710000050	DIODE	1SS53
D2	1730000120	ZENER	RD6.2E B2
D3	1790000070	DIODE	1SS237
D4	1790000070	DIODE	1SS237
D8	1720000060	VARICAP	1SV50 (1) E
D9	1710000050	DIODE	1SS53
D10	1710000160	DIODE	1SS133
D11	1710000160	DIODE	1SS133
D12	1710000160	DIODE	1SS133
D13	1710000160	DIODE	1SS133
X1	6050008190	XTAL	CR-404 9.46500MHz
X2	6070000010	DISCRIMINATOR	CDB455C7A
X3	6050000280	XTAL	HC-12/U 9.0105MHz
F11	2020000120	CERAMIC	CFW455E
L1	6180001710	COIL	LAL 03NA 561K
L2	6180001680	COIL	LAL 03NA 151K
L3	6150001200	COIL	LS-133
L4	6180000950	COIL	LAL 03NA 150K
L5	6180000880	COIL	LAL 03NA 100K
L6	6180000880	COIL	LAL 03NA 100K
L7	6180000900	COIL	LAL 03NA 101K
L8	6180000900	COIL	LAL 03NA 101K
L9	6180000960	COIL	LAL 03NA 102K
R1	7010003400	RESISTOR	ELR20J 1 kΩ
R2	7010001030	RESISTOR	R25XJ 100 Ω
R3	7010003420	RESISTOR	ELR20J 1.5 kΩ
R4	7010003420	RESISTOR	ELR20J 1.5 kΩ
R5	7010003620	RESISTOR	ELR20J 47 kΩ
R6	7010003420	RESISTOR	ELR20J 1.5 kΩ
R7	7010003540	RESISTOR	ELR20J 12 kΩ
R8	7010003580	RESISTOR	ELR20J 22 kΩ
R10	7510000320	THERMISTOR	ERT-D22ZGL 202S
R11	7010003360	RESISTOR	ELR20J 470 Ω
R14	7310000720	TRIMMER	RH0651CJ3J0CA (222)
R16	7010003280	RESISTOR	ELR20J 100 Ω
R17	7510000240	THERMISTOR	ERT-D22ZGL 332S
R18	7010003510	RESISTOR	ELR20J 6.8 kΩ
R19	7010003580	RESISTOR	ELR20J 22 kΩ
R20	7010003740	RESISTOR	ELR20J 470 kΩ
R21	7010003480	RESISTOR	ELR20J 4.7 kΩ
R22	7010003510	RESISTOR	ELR20J 6.8 kΩ
R23	7010001320	RESISTOR	R25XJ 22 kΩ
R24	7010004370	RESISTOR	R20J 22 kΩ
R25	7010003420	RESISTOR	ELR20J 1.5 kΩ
R26	7310000710	TRIMMER	RH0651C13J1YA (102)

[NOTCH BOARD]

REF. NO.	ORDER NO.	DESCRIPTION	
IC1	1110001220	S. IC	BA4558F T1
IC2	1130005640	S. IC	TC4W53F (TE12L)
IC3	1130005640	S. IC	TC4W53F (TE12L)
Q1	1530002060	S. TRANSISTOR	2SC4081 T107 R
Q2	1530002060	S. TRANSISTOR	2SC4081 T107 R
R1	7030003410	S. RESISTOR	ERJ3GEYJ 561 V (560 Ω)
R2	7030003640	S. RESISTOR	ERJ3GEYJ 473 V (47 kΩ)
R3	7030003680	S. RESISTOR	ERJ3GEYJ 104 V (100 kΩ)
R4	7030003680	S. RESISTOR	ERJ3GEYJ 104 V (100 kΩ)
R5	7030003780	S. RESISTOR	ERJ3GEYJ 684 V (680 kΩ)
R6	7030003680	S. RESISTOR	ERJ3GEYJ 104 V (100 kΩ)
R7	7030003670	S. RESISTOR	ERJ3GEYJ 823 V (82 kΩ)
R8	7310003560	S. TRIMMER	RV-220 (RH03AVAJ4) 223
R9	7030003680	S. RESISTOR	ERJ3GEYJ 104 V (100 kΩ)
R10	7030003680	S. RESISTOR	ERJ3GEYJ 104 V (100 kΩ)
R11	7030003680	S. RESISTOR	ERJ3GEYJ 104 V (100 kΩ)
R12	7030003680	S. RESISTOR	ERJ3GEYJ 104 V (100 kΩ)
R13	7030003680	S. RESISTOR	ERJ3GEYJ 104 V (100 kΩ)
R14	7030003510	S. RESISTOR	ERJ3GEYJ 392 V (3.9 kΩ)
R15	7030003680	S. RESISTOR	ERJ3GEYJ 104 V (100 kΩ)
R16	7030003440	S. RESISTOR	ERJ3GEYJ 102 V (1 kΩ)
R17	7030003240	S. RESISTOR	ERJ3GEYJ 220 V (22 Ω)
R18	7030003480	S. RESISTOR	ERJ3GEYJ 222 V (2.2 kΩ)
R19	7030003440	S. RESISTOR	ERJ3GEYJ 102 V (1 kΩ)
R20	7030003560	S. RESISTOR	ERJ3GEYJ 103 V (10 kΩ)
R21	7030003680	S. RESISTOR	ERJ3GEYJ 104 V (100 kΩ)
C1	4030009880	S. CERAMIC	C1608 JB 1H 682K-T-A
C2	4030009880	S. CERAMIC	C1608 JB 1H 682K-T-A
C3	4030006810	S. CERAMIC	C1608 SL 1H 271J-T-A
C4	4550000270	S. TANTALUM	TESVA 1E 474M1-8L
C5	4550000550	S. TANTALUM	TESVA 1V 224M1-8L
C6	4550000460	S. TANTALUM	TESVA 1C 105M1-8L
C7	4030008920	S. CERAMIC	C1608 JB 1C 473K-T-A
C8	4030006880	S. CERAMIC	C1608 JB 1H 472K-T-A
W1	7030003860	S. JUMPER	ERJ3GE JPW V
W2	7030003860	S. JUMPER	ERJ3GE JPW V
W3	7030003860	S. JUMPER	ERJ3GE JPW V
W4	7030003860	S. JUMPER	ERJ3GE JPW V
W5	7030003860	S. JUMPER	ERJ3GE JPW V
W6	7030003860	S. JUMPER	ERJ3GE JPW V
W7	7030003860	S. JUMPER	ERJ3GE JPW V
W8	7030003860	S. JUMPER	ERJ3GE JPW V
W9	7030003860	S. JUMPER	ERJ3GE JPW V
W10	7030003860	S. JUMPER	ERJ3GE JPW V
W11	7030003860	S. JUMPER	ERJ3GE JPW V
EP1	0910037332	PCB	B 3664B (NOTCH)
EP2	6910002720	LEADFRAME	HFB2.54-0.9-8 (N)

S. = Surface mount

[FMAM UNIT]

REF. NO.	ORDER NO.	DESCRIPTION	
R27	7010003420	RESISTOR	ELR20J 1.5 kΩ
R28	7010004190	RESISTOR	R20J 1 kΩ
R29	7010004950	RESISTOR	R20J 1.5 MΩ
R30	7010003400	RESISTOR	ELR20J 1 kΩ
R31	7010003780	RESISTOR	ELR20J 1 MΩ
R32	7010004190	RESISTOR	R20J 1 kΩ
R33	7010003410	RESISTOR	ELR20J 1.2 kΩ
R34	7010005090	RESISTOR	ELR20J 910 Ω
R35	7010003440	RESISTOR	ELR20J 2.2 kΩ
R36	7010003530	RESISTOR	ELR20J 10 kΩ
R37	7010004430	RESISTOR	R20J 68 kΩ
R38	7010004430	RESISTOR	R20J 68 kΩ
R39	7010003640	RESISTOR	ELR20J 68 kΩ
R40	7010000910	RESISTOR	R25XJ 10 Ω
R41	7310000740	TRIMMER	RH0651CS3J2KA (472)
R42	7010004230	RESISTOR	R20J 2.2 kΩ
R43	7010004270	RESISTOR	R20J 4.7 kΩ
R44	7310000750	TRIMMER	RH0651C14J2WA (103)
R45	7010003530	RESISTOR	ELR20J 10 kΩ
R46	7010003470	RESISTOR	ELR20J 3.9 kΩ
R47	7310000750	TRIMMER	RH0651C14J2WA (103)
R48	7010004310	RESISTOR	R20J 8.2 kΩ
R49	7010003580	RESISTOR	ELR20J 22 kΩ
R50	7010003810	RESISTOR	ELR20J 2.2 MΩ
R51	7010003550	RESISTOR	ELR20J 15 kΩ
R52	7010003400	RESISTOR	ELR20J 1 kΩ
R53	7310000740	TRIMMER	RH0651CS3J2KA (472)
R54	7010003360	RESISTOR	ELR20J 470 Ω
R55	7010003400	RESISTOR	ELR20J 1 kΩ
R58	7010004270	RESISTOR	R20J 4.7 kΩ
C1	4010000260	CERAMIC	DD104 SL 470J 50V
C2	4010000520	CERAMIC	DD108 B 472K 50V
C3	4010000760	CERAMIC	DD104 CH 180J 50V
C4	4010000360	CERAMIC	DD106 SL 181J 50V
C5	4040000260	BARRIER	UZE 08X 104M
C6	4040000260	BARRIER	UZE 08X 104M
C7	4010000320	CERAMIC	DD104 SL 820J 50V
C8	4040000260	BARRIER	UZE 08X 104M
C9	4510003800	ELECTROLYTIC	25 MV 4R7 SW
C10	4010000150	CERAMIC	DD104 SL 150J 50V
C11	4040000250	BARRIER	UAT 08X 473M
C12	4040000460	BARRIER	RAU 08SA 821K
C13	4040000250	BARRIER	UAT 08X 473M
C14	4040000250	BARRIER	UAT 08X 473M
C15	4040000250	BARRIER	UAT 08X 473M
C16	4040000190	BARRIER	UAT 05X 103K
C17	4040000260	BARRIER	UZE 08X 104M
C19	4310000400	MYLER	50 F2D 223J
C20	4310000400	MYLER	50 F2D 223J
C21	4040000250	BARRIER	UAT 08X 473M
C22	4010000520	CERAMIC	DD108 B 472K 50V
C23	4010000520	CERAMIC	DD108 B 472K 50V
C24	4010000150	CERAMIC	DD104 SL 150J 50V
C25	4010000090	CERAMIC	DD104 SL 070D 50V
C26	4010000940	CERAMIC	DD107 CH 101J 50V
C27	4010000940	CERAMIC	DD107 CH 101J 50V
C28	4010000520	CERAMIC	DD108 B 472K 50V
C29	4040000150	BARRIER	UAT 05X 472K
C30	4010000520	CERAMIC	DD108 B 472K 50V
C31	4010000460	CERAMIC	DD104 B 471K 50V
C32	4510003820	ELECTROLYTIC	50 MV R22 SW
C33	4010000520	CERAMIC	DD108 B 472K 50V
C34	4010000520	CERAMIC	DD108 B 472K 50V
C35	4010000520	CERAMIC	DD108 B 472K 50V
C36	4010000520	CERAMIC	DD108 B 472K 50V
C37	4510003830	ELECTROLYTIC	50 MV R47 SW
C38	4310000570	MYLER	50 F2D 222J
C39	4510003790	ELECTROLYTIC	16 MV 10 SW
C40	4510003790	ELECTROLYTIC	16 MV 10 SW
C41	4510003790	ELECTROLYTIC	16 MV 10 SW
C42	4010000500	CERAMIC	DD104 B 102K 50V
C43	4040000310	BARRIER	UAT 04V 222K
C44	4010000340	CERAMIC	DD105 SL 121J 50V

[FMAM UNIT]

REF. NO.	ORDER NO.	DESCRIPTION	
C45	4510003820	ELECTROLYTIC	50 MV R22 SW
C46	4510004950	ELECTROLYTIC	50 MV R47 SWNP
C48	4510003840	ELECTROLYTIC	50 MV 1 SW
C49	4010000330	CERAMIC	DD105 SL 101J 50V
C50	4510003860	ELECTROLYTIC	50 MV 3R3 SW
C51	4510004910	ELECTROLYTIC	16 MV 10 SWNP
C52	4010000520	CERAMIC	DD108 B 472K 50V
C53	4010000520	CERAMIC	DD108 B 472K 50V
C58	4040000190	BARRIER	UAT 05X 103K
J1	6510007990	CONNECTOR	3022-10B
J2	6510008000	CONNECTOR	TSL-P03P-D2
J3	6510007010	CONNECTOR	001P-1100
W17	7120000020	JUMPER	JPW 02H
EP1	0910036132	PCB	B 3608B (FMAM)

[PLL UNIT]

REF. NO.	ORDER NO.	DESCRIPTION	
IC6	1110000240	IC	BA222-V
IC9	1120000970	IC	M54562P
IC13	1130002960	IC	TC9181P
IC14	1120001620	IC	M74ALS74AP
IC15	1120001620	IC	M74ALS74AP
IC16	1110001320	IC	μPC1037HA
IC17	1110001320	IC	μPC1037HA
IC22	1110000290	IC	BA618
IC23	1130000180	IC	TC4094BP
IC24	1130000180	IC	TC4094BP
IC25	1130000180	IC	TC4094BP
Q12	1530000940	TRANSISTOR	2SC1571G
Q13	1530000110	TRANSISTOR	2SC2458-GR
Q14	1530000110	TRANSISTOR	2SC2458-GR
Q15	1560000090	FET	2SK192A-GR
Q16	1530000110	TRANSISTOR	2SC2458-GR
Q17	1560000090	FET	2SK192A-GR
Q18	1530000110	TRANSISTOR	2SC2458-GR
Q19	1560000090	FET	2SK192A-GR
Q20	1530000110	TRANSISTOR	2SC2458-GR
Q21	1560000090	FET	2SK192A-GR
Q22	1530000110	TRANSISTOR	2SC2458-GR
Q23	1530000150	TRANSISTOR	2SC2668-O
Q24	1530000150	TRANSISTOR	2SC2668-O
Q25	1590000340	TRANSISTOR	RN1202
Q26	1530000150	TRANSISTOR	2SC2668-O
Q27	1530000150	TRANSISTOR	2SC2668-O
Q29	1560000090	FET	2SK192A-GR
Q30	1530000150	TRANSISTOR	2SC2668-O
Q31	1590000360	TRANSISTOR	RN2202
Q32	1530000100	TRANSISTOR	2SC2458-Y
Q33	1530000110	TRANSISTOR	2SC2458-GR
Q34	1530000150	TRANSISTOR	2SC2668-O
Q36	1530000150	TRANSISTOR	2SC2668-O
Q46	1530000150	TRANSISTOR	2SC2668-O
Q50	1590000340	TRANSISTOR	RN1202
Q51	1590000360	TRANSISTOR	RN2202
Q52	1590000340	TRANSISTOR	RN1202
Q53	1590000340	TRANSISTOR	RN1202
Q54	1590000360	TRANSISTOR	RN2202

[PLL UNIT]

REF. NO.	ORDER NO.	DESCRIPTION	
D8	1710000160	DIODE	1SS133
D9	1710000160	DIODE	1SS133
D10	1730000100	ZENER	RD5.1E B2
D21	1710000160	DIODE	1SS133
D22	1710000611	DIODE	1SS133 T77 (26M/M)
D23	1710000160	DIODE	1SS133
D24	1710000160	DIODE	1SS133
D25	1710000160	DIODE	1SS133
D26	1710000160	DIODE	1SS133
D27	1710000160	DIODE	1SS133
D28	1710000160	DIODE	1SS133
D29	1710000050	DIODE	1SS53
D30	1710000050	DIODE	1SS53
D31	1710000050	DIODE	1SS53
D32	1710000050	DIODE	1SS53
D33	1710000050	DIODE	1SS53
D34	1710000050	DIODE	1SS53
D35	1710000160	DIODE	1SS133
D36	1710000160	DIODE	1SS133
D37	1710000160	DIODE	1SS133
D38	1710000160	DIODE	1SS133
D39	1710000160	DIODE	1SS133
D40	1710000160	DIODE	1SS133
D41	1710000160	DIODE	1SS133
D42	1710000611	DIODE	1SS133 T77 (26M/M)
D47	1710000050	DIODE	1SS53
D48	1720000230	VARICAP	1SV101
D49	1710000050	DIODE	1SS53
D50	1720000230	VARICAP	1SV101
D51	1710000050	DIODE	1SS53
D52	1720000230	VARICAP	1SV101
D53	1710000050	DIODE	1SS53
D54	1720000230	VARICAP	1SV101
D55	1710000050	DIODE	1SS53
D56	1720000120	VARICAP	FC52M
D82	1710000160	DIODE	1SS133
D83	1710000611	DIODE	1SS133 T77 (26M/M)
D84	1710000611	DIODE	1SS133 T77 (26M/M)
X2	6050005710	XTAL	CR-275
L2	6140000580	COIL	LR-79
L3	6110002740	COIL	LA-472
L4	6170000230	COIL	LW-25
L5	6140000580	COIL	LR-79
L6	6110002740	COIL	LA-472
L7	6170000230	COIL	LW-25
L8	6140000580	COIL	LR-79
L9	6110002740	COIL	LA-472
L10	6170000230	COIL	LW-25
L11	6140000580	COIL	LR-79
L12	6110002740	COIL	LA-472
L13	6170000230	COIL	LW-25
L14	6180000900	COIL	LAL 03NA 101K
L15	6180000900	COIL	LAL 03NA 101K
L16	6180000740	COIL	LAL 03NA R56M
L17	6110001560	COIL	LA-236
L18	6110001560	COIL	LA-236
L19	6110001550	COIL	LA-235
L20	6180000900	COIL	LAL 03NA 101K
L23	6180000700	COIL	LAL 03NA R27M
L24	6180000700	COIL	LAL 03NA R27M
L25	6180000690	COIL	LAL 03NA R22M
L26	6180000960	COIL	LAL 03NA 102K
L27	6180000900	COIL	LAL 03NA 101K
L28	6180000900	COIL	LAL 03NA 101K
L29	6180000900	COIL	LAL 03NA 101K
L30	6150003100	COIL	LS-316
L31	6180000850	COIL	LAL 03NA 4R7K
L32	6180000850	COIL	LAL 03NA 4R7K
L33	6910000670	COIL	BT01RN1-A61-001
L34	6170000180	COIL	LW-19
L35	6150000760	COIL	LS-94

[PLL UNIT]

REF. NO.	ORDER NO.	DESCRIPTION	
L36	6180001510	COIL	LAL 02NA 101K
L37	6180000900	COIL	LAL 03NA 101K
L38	6150000990	COIL	LS-114
L39	6150000990	COIL	LS-114
L41	6110001650	COIL	LA-248
L42	6140000580	COIL	LR-79
L43	6180000900	COIL	LAL 03NA 101K
L47	6180000900	COIL	LAL 03NA 101K
L48	6180000960	COIL	LAL 03NA 102K
L49	6110001560	COIL	LA-236
L63	6180000900	COIL	LAL 03NA 101K
L64	6180000900	COIL	LAL 03NA 101K
L65	6180000900	COIL	LAL 03NA 101K
L66	6180000960	COIL	LAL 03NA 102K
L69	6180000900	COIL	LAL 03NA 101K
L70	6180000860	COIL	LAL 03NA 5R6K
L71	6180000900	COIL	LAL 03NA 101K
L72	6180000880	COIL	LAL 03NA 100K
L73	6180000960	COIL	LAL 03NA 102K
R29	7010001111	RESISTOR	R25X T-24J 470 Ω
R30	7010001111	RESISTOR	R25X T-24J 470 Ω
R31	7010001111	RESISTOR	R25X T-24J 470 Ω
R32	7010004191	RESISTOR	R20 T-24J 1 kΩ
R33	7010001151	RESISTOR	R25X T-24J 1 kΩ
R34	7010004191	RESISTOR	R20 T-24J 1 kΩ
R35	7010005230	RESISTOR	ELR20J 750 Ω
R36	7010003430	RESISTOR	ELR20J 1.8 kΩ
R37	7010003460	RESISTOR	ELR20J 3.3 kΩ
R38	7010003490	RESISTOR	ELR20J 5.6 kΩ
R39	7010003540	RESISTOR	ELR20J 12 kΩ
R40	7010004271	RESISTOR	R20 T-24J 4.7 kΩ
R51	7010003240	RESISTOR	ELR20J 47 Ω
R52	7010003660	RESISTOR	ELR20J 100 kΩ
R53	7010003530	RESISTOR	ELR20J 10 kΩ
R54	7010004031	RESISTOR	R20 T-24J 47 Ω
R71	7010003550	RESISTOR	ELR20J 15 kΩ
R72	7010004071	RESISTOR	R20 T-24J 100 Ω
R74	7010003400	RESISTOR	ELR20J 1 kΩ
R75	7010003700	RESISTOR	ELR20J 220 kΩ
R76	7010003440	RESISTOR	ELR20J 2.2 kΩ
R77	7010001190	RESISTOR	R25XJ 2.2 kΩ
R78	7010003660	RESISTOR	ELR20J 100 kΩ
R79	7010003660	RESISTOR	ELR20J 100 kΩ
R80	7010004101	RESISTOR	R20 T-24J 180 Ω
R82	7010003660	RESISTOR	ELR20J 100 kΩ
R83	7010003660	RESISTOR	ELR20J 100 kΩ
R85	7010003660	RESISTOR	ELR20J 100 kΩ
R86	7010004451	RESISTOR	R20 T-24J 100 kΩ
R88	7010003660	RESISTOR	ELR20J 100 kΩ
R89	7010003660	RESISTOR	ELR20J 100 kΩ
R91	7010004101	RESISTOR	R20 T-24J 180 Ω
R92	7010004251	RESISTOR	R20 T-24J 3.3 kΩ
R93	7010004091	RESISTOR	R20 T-24J 150 Ω
R94	7010004251	RESISTOR	R20 T-24J 3.3 kΩ
R95	7010003300	RESISTOR	ELR20J 150 Ω
R96	7010004251	RESISTOR	R20 T-24J 3.3 kΩ
R97	7010003300	RESISTOR	ELR20J 150 Ω
R98	7010003460	RESISTOR	ELR20J 3.3 kΩ
R101	7010003360	RESISTOR	ELR20J 470 Ω
R103	7010000991	RESISTOR	R25X T-24J 47 Ω
R104	7010003480	RESISTOR	ELR20J 4.7 kΩ
R105	7010004111	RESISTOR	R20 T-24J 220 Ω
R106	7010003340	RESISTOR	ELR20J 330 Ω
R107	7010003991	RESISTOR	R20 T-24J 22 Ω
R108	7010003400	RESISTOR	ELR20J 1 kΩ
R109	7010003490	RESISTOR	ELR20J 5.6 kΩ
R110	7010004031	RESISTOR	R20 T-24J 47 Ω
R111	7010003220	RESISTOR	ELR20J 33 Ω
R112	7010003320	RESISTOR	ELR20J 220 Ω
R113	7010003390	RESISTOR	ELR20J 820 Ω
R114	7010003921	RESISTOR	R20 T-24J 5.6 Ω
R115	7010003390	RESISTOR	ELR20J 820 Ω
R116	7010004191	RESISTOR	R20 T-24J 1 kΩ

[PLL UNIT]

REF. NO.	ORDER NO.	DESCRIPTION
R117	7010004191	RESISTOR R20 T-24J 1 kΩ
R118	7010004191	RESISTOR R20 T-24J 1 kΩ
R119	7010001071	RESISTOR R25X T-24J 220 Ω
R121	7010003480	RESISTOR ELR20J 4.7 kΩ
R123	7010003280	RESISTOR ELR20J 100 Ω
R124	7010004151	RESISTOR R20 T-24J 470 Ω
R125	7010003620	RESISTOR ELR20J 47 kΩ
R126	7010003510	RESISTOR ELR20J 6.8 kΩ
R127	7010000951	RESISTOR R25X T-24J 22 Ω
R128	7010003360	RESISTOR ELR20J 470 Ω
R129	7010004111	RESISTOR R20 T-24J 220 Ω
R130	7010004191	RESISTOR R20 T-24J 1 kΩ
R131	7010004191	RESISTOR R20 T-24J 1 kΩ
R132	7010004191	RESISTOR R20 T-24J 1 kΩ
R133	7010004271	RESISTOR R20 T-24J 4.7 kΩ
R134	7010003160	RESISTOR ELR20J 10 Ω
R137	7010003660	RESISTOR ELR20J 100 kΩ
R138	7010003300	RESISTOR ELR20J 150 Ω
R141	7010003460	RESISTOR ELR20J 3.3 kΩ
R142	7010004131	RESISTOR R20 T-24J 330 Ω
R143	7010003280	RESISTOR ELR20J 100 Ω
R144	7010003280	RESISTOR ELR20J 100 Ω
R145	7010003240	RESISTOR ELR20J 47 Ω
R146	7010004071	RESISTOR R20 T-24J 100 Ω
R149	7010004071	RESISTOR R20 T-24J 100 Ω
R150	7010004191	RESISTOR R20 T-24J 1 kΩ
R151	7010003640	RESISTOR ELR20J 68 kΩ
R152	7010003440	RESISTOR ELR20J 2.2 kΩ
R155	7010001151	RESISTOR R25X T-24J 1 kΩ
R156	7010003480	RESISTOR ELR20J 4.7 kΩ
R157	7010003550	RESISTOR ELR20J 15 kΩ
R158	7010003360	RESISTOR ELR20J 470 Ω
R159	7010003240	RESISTOR ELR20J 47 Ω
R160	7010003320	RESISTOR ELR20J 220 Ω
R161	7010003530	RESISTOR ELR20J 10 kΩ
R162	7010003410	RESISTOR ELR20J 1.2 kΩ
R163	7010003580	RESISTOR ELR20J 22 kΩ
R164	7010004431	RESISTOR R20 T-24J 68 kΩ
R165	7010003330	RESISTOR ELR20J 270 Ω
R166	7010004071	RESISTOR R20 T-24J 100 Ω
R167	7010001281	RESISTOR R25X T-24J 10 kΩ
R168	7010001281	RESISTOR R25X T-24J 10 kΩ
R169	7010001281	RESISTOR R25X T-24J 10 kΩ
R170	7010001281	RESISTOR R25X T-24J 10 kΩ
R171	7010003620	RESISTOR ELR20J 47 kΩ
R172	7010003620	RESISTOR ELR20J 47 kΩ
R173	7010004151	RESISTOR R20 T-24J 470 Ω
R176	7010003360	RESISTOR ELR20J 470 Ω
R177	7010003360	RESISTOR ELR20J 470 Ω
R178	7010003360	RESISTOR ELR20J 470 Ω
R181	7010003760	RESISTOR ELR20J 680 kΩ
R182	7010003530	RESISTOR ELR20J 10 kΩ
R205	7010004111	RESISTOR R20 T-24J 220 Ω
R206	7010003530	RESISTOR ELR20J 10 kΩ
R207	7010003580	RESISTOR ELR20J 22 kΩ
R208	7010003360	RESISTOR ELR20J 470 Ω
R209	7010003280	RESISTOR ELR20J 100 Ω
R213	7410000530	ARRAY RMX- 7 103K
R214	7010004071	RESISTOR R20 T-24J 100 Ω
R215	7010003660	RESISTOR ELR20J 100 kΩ
R223	7510000260	THERMISTOR ERT-D2ZGL 102S
R224	7010003470	RESISTOR ELR20J 3.9 kΩ
R225	7010003320	RESISTOR ELR20J 220 Ω
R227	7010003400	RESISTOR ELR20J 1 kΩ
R228	7010003400	RESISTOR ELR20J 1 kΩ
R229	7010003400	RESISTOR ELR20J 1 kΩ
R230	7010003400	RESISTOR ELR20J 1 kΩ
R231	7010003400	RESISTOR ELR20J 1 kΩ
R232	7010003400	RESISTOR ELR20J 1 kΩ
R233	7010003400	RESISTOR ELR20J 1 kΩ
R234	7010003400	RESISTOR ELR20J 1 kΩ
R235	7010003400	RESISTOR ELR20J 1 kΩ
R236	7010003400	RESISTOR ELR20J 1 kΩ
R237	7010003400	RESISTOR ELR20J 1 kΩ
R238	7010003400	RESISTOR ELR20J 1 kΩ

[PLL UNIT]

REF. NO.	ORDER NO.	DESCRIPTION
R239	7010003400	RESISTOR ELR20J 1 kΩ
R240	7010001231	RESISTOR R25X T-24J 4.7 kΩ
R241	7010003040	RESISTOR ELR20J 1 Ω
R242	7010003660	RESISTOR ELR20J 100 kΩ
C8	4010000500	CERAMIC DD104 B 102K 50V
C9	4310000330	MYLER 50 F2D 102J
C10	45100003790	ELECTROLYTIC 16 MV 10 SW
C11	4550000340	TANTALUM DN 1C 100M
C12	4550000340	TANTALUM DN 1C 100M
C13	4550000400	TANTALUM DN 1C 2R2M
C21	4530000380	ARRAY B9HC0114-33N
C24	4040000250	BARRIER UAT 08X 473M
C25	4010004840	CERAMIC DD305 F 104Z 12V
C26	4010000520	CERAMIC DD108 B 472K 50V
C27	4510004990	ELECTROLYTIC 16 MV 100 HC
C28	4010000500	CERAMIC DD104 B 102K 50V
C29	4510004950	ELECTROLYTIC 50 MV R47 SWNP
C31	4010003460	CERAMIC DD104 UJ 330J 50V
C32	4040000250	BARRIER UAT 08X 473M
C33	4010000940	CERAMIC DD107 CH 101J 50V
C34	4010000770	CERAMIC DD104 CH 200J 50V
C35	4610001130	TRIMMER CVSSA1001
C36	4010000900	CERAMIC DD107 CH 680J 50V
C38	4010000720	CERAMIC DD104 CH 120J 50V
C39	4010000720	CERAMIC DD104 CH 120J 50V
C40	4010000520	CERAMIC DD108 B 472K 50V
C41	4010000520	CERAMIC DD108 B 472K 50V
C42	4010000060	CERAMIC DD104 SL 040C 50V
C43	4010000500	CERAMIC DD104 B 102K 50V
C44	4010000900	CERAMIC DD107 CH 680J 50V
C45	4010000740	CERAMIC DD104 CH 150J 50V
C46	4610001130	TRIMMER CVSSA1001
C47	4010000860	CERAMIC DD106 CH 470J 50V
C49	4010000720	CERAMIC DD104 CH 120J 50V
C50	4010000720	CERAMIC DD104 CH 120J 50V
C51	4010000520	CERAMIC DD108 B 472K 50V
C52	4010000520	CERAMIC DD108 B 472K 50V
C53	4010000060	CERAMIC DD104 SL 040C 50V
C54	4010000880	CERAMIC DD106 CH 560J 50V
C55	4010000850	CERAMIC DD106 CH 430J 50V
C56	4010000500	CERAMIC DD104 B 102K 50V
C57	4010000870	CERAMIC DD106 CH 510J 50V
C58	4010000700	CERAMIC DD104 CH 100D 50V
C59	4610001000	TRIMMER CVSSA0701
C60	4010000860	CERAMIC DD106 CH 470J 50V
C62	4010000680	CERAMIC DD104 CH 080D 50V
C63	4010000720	CERAMIC DD104 CH 120J 50V
C64	4010000520	CERAMIC DD108 B 472K 50V
C65	4010000520	CERAMIC DD108 B 472K 50V
C66	4010000050	CERAMIC DD104 SL 030C 50V
C67	4010000500	CERAMIC DD104 B 102K 50V
C68	4010000860	CERAMIC DD106 CH 470J 50V
C69	4010000630	CERAMIC DD104 CJ 030C 50V
C70	4610001000	TRIMMER CVSSA0701
C71	4010000820	CERAMIC DD105 CH 330J 50V
C73	4010000660	CERAMIC DD104 CH 060D 50V
C74	4010000720	CERAMIC DD104 CH 120J 50V
C75	4010000520	CERAMIC DD108 B 472K 50V
C76	4010004840	CERAMIC DD305 F 104Z 12V
C77	4510004990	ELECTROLYTIC 16 MV 100 HC
C78	4010000520	CERAMIC DD108 B 472K 50V
C79	4010000050	CERAMIC DD104 SL 030C 50V
C80	4010000500	CERAMIC DD104 B 102K 50V
C81	4010000260	CERAMIC DD104 SL 470J 50V
C82	4040000150	BARRIER UAT 05X 472K
C83	4010000460	CERAMIC DD104 B 471K 50V
C84	4040000250	BARRIER UAT 08X 473M
C85	4010000380	CERAMIC DD107 SL 221J 50V
C86	4010000500	CERAMIC DD104 B 102K 50V
C87	4010000240	CERAMIC DD104 SL 390J 50V
C88	4010000150	CERAMIC DD104 SL 150J 50V
C89	4010000240	CERAMIC DD104 SL 390J 50V
C90	4010000160	CERAMIC DD104 SL 180J 50V

[PLL UNIT]

REF. NO.	ORDER NO.	DESCRIPTION
C91	4010000200	CERAMIC DD104 SL 270J 50V
C92	4010000230	CERAMIC DD104 SL 360J 50V
C93	4010000180	CERAMIC DD104 SL 220J 50V
C94	4010000120	CERAMIC DD104 SL 100D 50V
C95	4040000150	BARRIER UAT 05X 472K
C96	4010000520	CERAMIC DD108 B 472K 50V
C97	4010000520	CERAMIC DD108 B 472K 50V
C98	4010000520	CERAMIC DD108 B 472K 50V
C99	4010000300	CERAMIC DD104 SL 680J 50V
C100	4010000080	CERAMIC DD104 SL 060D 50V
C101	4010000320	CERAMIC DD104 SL 820J 50V
C102	4010000160	CERAMIC DD104 SL 180J 50V
C103	4010000310	CERAMIC DD104 SL 750J 50V
C104	4010000520	CERAMIC DD108 B 472K 50V
C105	4010004840	CERAMIC DD305 F 104Z 12V
C106	4010000520	CERAMIC DD108 B 472K 50V
C107	4040000250	BARRIER UAT 08X 473M
C108	4010000520	CERAMIC DD108 B 472K 50V
C109	4010000430	CERAMIC DD109 SL 471J 50V
C110	4010000020	CERAMIC DD104 SL 010C 50V
C111	4010000410	CERAMIC DD107 SL 331J 50V
C112	4040000190	BARRIER UAT 05X 103K
C113	4010004840	CERAMIC DD305 F 104Z 12V
C114	4550000400	TANTALUM DN 1C 2R2M
C115	4010000520	CERAMIC DD108 B 472K 50V
C116	4010000780	CERAMIC DD104 CH 220J 50V
C117	4010000890	CERAMIC DD106 CH 620J 50V
C118	4010000900	CERAMIC DD107 CH 680J 50V
C119	4010000720	CERAMIC DD104 CH 120J 50V
C120	4010000740	CERAMIC DD104 CH 150J 50V
C121	4040000150	BARRIER UAT 05X 472K
C122	4510003790	ELECTROLYTIC 16 MV 10 SW
C123	4010000500	CERAMIC DD104 B 102K 50V
C124	4010000520	CERAMIC DD108 B 472K 50V
C125	4010000520	CERAMIC DD108 B 472K 50V
C126	4010000380	CERAMIC DD107 SL 221J 50V
C127	4010004840	CERAMIC DD305 F 104Z 12V
C128	4010004840	CERAMIC DD305 F 104Z 12V
C129	4040000150	BARRIER UAT 05X 472K
C130	4010000500	CERAMIC DD104 B 102K 50V
C131	4040000260	BARRIER UZE 08X 104M
C132	4510003910	ELECTROLYTIC 16 MV 47 HW
C133	4010000270	CERAMIC DD104 SL 510J 50V
C134	4610001120	TRIMMER CVSSC2001
C135	4010003100	CERAMIC DD106 TH 820J 50V
C136	4010000520	CERAMIC DD108 B 472K 50V
C137	4010000520	CERAMIC DD108 B 472K 50V
C138	4010003120	CERAMIC DD107 TH 101J 50V
C139	4550000320	TANTALUM DN 1V 0R1M
C140	4040000150	BARRIER UAT 05X 472K
C141	4010000500	CERAMIC DD104 B 102K 50V
C143	4010000500	CERAMIC DD104 B 102K 50V
C144	4010000380	CERAMIC DD107 SL 221J 50V
C145	4010004840	CERAMIC DD305 F 104Z 12V
C146	4010000100	CERAMIC DD104 SL 080D 50V
C147	4010000520	CERAMIC DD108 B 472K 50V
C148	4010000010	CERAMIC DD104 SL 0R5C 50V
C149	4010000100	CERAMIC DD104 SL 080D 50V
C151	4010004840	CERAMIC DD305 F 104Z 12V
C157	4010000520	CERAMIC DD108 B 472K 50V
C158	4040000150	BARRIER UAT 05X 472K
C159	4010000520	CERAMIC DD108 B 472K 50V
C162	4010000210	CERAMIC DD104 SL 300J 50V
C163	4010000180	CERAMIC DD104 SL 220J 50V
C164	4010000210	CERAMIC DD104 SL 300J 50V
C165	4020000260	CYLINDER TP125 X 103M
C169	4010000010	CERAMIC DD104 SL 0R5C 50V
C190	4510003850	ELECTROLYTIC 50 MV 2R2 SW
C196	4550000400	TANTALUM DN 1C 2R2M
C197	4010000050	CERAMIC DD104 SL 030C 50V
C199	4010000500	CERAMIC DD104 B 102K 50V
C200	4010000520	CERAMIC DD108 B 472K 50V
C201	4010000520	CERAMIC DD108 B 472K 50V
C202	4530000270	ARRAY B8XC0114-32N
C203	4010000520	CERAMIC DD108 B 472K 50V

[PLL UNIT]

REF. NO.	ORDER NO.	DESCRIPTION
C204	4010000520	CERAMIC DD108 B 472K 50V
C205	4610001120	TRIMMER CVSSC2001
C207	4010000520	CERAMIC DD108 B 472K 50V
C209	4010004840	CERAMIC DD305 F 104Z 12V
C210	4010000520	CERAMIC DD108 B 472K 50V
C211	4040000190	BARRIER UAT 05X 103K
C213	4010000520	CERAMIC DD108 B 472K 50V
C214	4010000520	CERAMIC DD108 B 472K 50V
C215	4010000520	CERAMIC DD108 B 472K 50V
C216	4040000160	BARRIER UAT 05X 472K
C217	4530000190	ARRAY B7ZC0716-32N
C218	4010000520	CERAMIC DD108 B 472K 50V
C219	4010000500	CERAMIC DD104 B 102K 50V
C220	4510003790	ELECTROLYTIC 16 MV 10 SW
J22	6510003390	CONNECTOR B03B-EH-S
J23	6510003400	CONNECTOR B04B-EH-S
J24	6510003430	CONNECTOR B07B-EH-S
J25	6510003420	CONNECTOR B06B-EH-S
W243	7120000010	JUMPER JPW 02A
EP2	0910037274	PCB B 3661D (PLL)

[DDS BOARD]

REF. NO.	ORDER NO.	DESCRIPTION
IC1	1140000500	S. IC SC1051
IC2	1130000570	S. IC SC1052
IC3	1130000580	S. IC SC1053
IC4	11300006580	S. IC TC74HCT374AF (TP1)
IC5	11300006580	S. IC TC74HCT374AF (TP1)
IC6	1130003830	S. IC TC7S04F (TE85R)
X1	6050003230	XTAL CR-180
L1	6200000040	S. COIL LQN 5N 331K
L2	6200000040	S. COIL LQN 5N 331K
L3	6200000040	S. COIL LQN 5N 331K
R1	7030000740	S. RESISTOR MCR10EZHZ 1 MΩ (105)
R2	7030000360	S. RESISTOR MCR10EZHZ 680 Ω (681)
R3	7030000420	S. RESISTOR MCR10EZHZ 2.2 kΩ (222)
R4	7410000320	ARRAY GF 5096
R5	7030000500	S. RESISTOR MCR10EZHZ 10 kΩ (103)
R6	7030000500	S. RESISTOR MCR10EZHZ 10 kΩ (103)
R7	7030000500	S. RESISTOR MCR10EZHZ 10 kΩ (103)
C1	4610000520	S. TRIMMER TZB04N100BA006
C2	4030000950	S. CERAMIC GRM40 CH 330J 50PT
C3	4030001150	S. CERAMIC GRM40 F 104Z 25PT
C7	4030000720	S. CERAMIC GRM40 SL 680J 50PT
C8	4030000560	S. CERAMIC GRM40 SL 020C 50PT
C9	4030000750	S. CERAMIC GRM40 SL 121J 50PT
C10	4030000610	S. CERAMIC GRM40 SL 070D 50PT
C11	4030000750	S. CERAMIC GRM40 SL 121J 50PT
C12	4030000640	S. CERAMIC GRM40 SL 120J 50PT
C13	4030000720	S. CERAMIC GRM40 SL 680J 50PT
C14	4030001150	S. CERAMIC GRM40 F 104Z 25PT
C15	4030001150	S. CERAMIC GRM40 F 104Z 25PT

S.=Surface mount

[DDS BOARD]

REF. NO.	ORDER NO.	DESCRIPTION	
C16	4030001150	S. CERAMIC	GRM40 F 104Z 25PT
C17	4030001150	S. CERAMIC	GRM40 F 104Z 25PT
C18	4030002430	S. CERAMIC	GRM40 TH 220J 50PT
C19	4030001100	S. CERAMIC	GRM40 B 102K 50PT
C20	4030001100	S. CERAMIC	GRM40 B 102K 50PT
C21	4030001150	S. CERAMIC	GRM40 F 104Z 25PT
J1	6510004950	CONNECTOR	3022-06B
J2	6510004960	CONNECTOR	3022-02B
EP1	0910028230	PCB	B 2853 (DDS)

[LOGIC UNIT]

REF. NO.	ORDER NO.	DESCRIPTION	
IC1	1110001550	S. IC	S-8054ALB-LM-T1
IC2	1110002020	IC	TA7805S
IC3	1140000930	S. IC	HD64180R1F6
IC4	1140003011	IC	SC-1225-1 (NMC27C256BQ150)
IC5	1130004050	S. IC	LC3517AML-15-TRM
IC6	1140003230	S. IC	TMP82C265BF-2
IC7	1130005890	S. IC	μPD4024BG-T1
IC8	1130005770	S. IC	MB4052PF-G-BND-TR
IC9	1130001920	S. IC	μPD4071BG-T1
IC10	1130004921	S. IC	TC74HC04AF (TP1)
IC11	1130005311	S. IC	TC74HC32AF (TP1)
IC12	1130005251	S. IC	TC74HC08AF (TP1)
IC13	1130001920	S. IC	μPD4071BG-T1
IC14	1130002660	S. IC	μPD4030BG-T1
IC15	1130001230	S. IC	μPD4001BG-T1
IC16	1130000830	S. IC	μPD4094BG-T1
Q1	1530002060	S. TRANSISTOR	2SC4081 T107 R
Q2	1530002060	S. TRANSISTOR	2SC4081 T107 R
Q3	1530002060	S. TRANSISTOR	2SC4081 T107 R
Q4	1510000510	S. TRANSISTOR	2SA1576 T107 R
Q5	1530002060	S. TRANSISTOR	2SC4081 T107 R
Q6	1590000680	S. TRANSISTOR	DTC114EU T107
Q7	1590000680	S. TRANSISTOR	DTC114EU T107
Q8	1590000680	S. TRANSISTOR	DTC114EU T107
Q9	1590000680	S. TRANSISTOR	DTC114EU T107
Q10	1590000680	S. TRANSISTOR	DTC114EU T107
Q11	1590000680	S. TRANSISTOR	DTC114EU T107
Q12	1590000680	S. TRANSISTOR	DTC114EU T107
Q13	1590000680	S. TRANSISTOR	DTC114EU T107
Q14	1590000680	S. TRANSISTOR	DTC114EU T107
Q15	1590000680	S. TRANSISTOR	DTC114EU T107
Q16	1590000680	S. TRANSISTOR	DTC114EU T107
Q17	1590000680	S. TRANSISTOR	DTC114EU T107
Q18	1530002060	S. TRANSISTOR	2SC4081 T107 R
Q19	1510000510	S. TRANSISTOR	2SA1576 T107 R
Q20	1510000510	S. TRANSISTOR	2SA1576 T107 R
Q21	1510000510	S. TRANSISTOR	2SA1576 T107 R
Q22	1590000680	S. TRANSISTOR	DTC114EU T107
Q23	1540000150	TRANSISTOR	2SD1225M R
Q24	1530002060	S. TRANSISTOR	2SC4081 T107 R
D1	1750000160	S. DIODE	DA114 T107
D3	1710000160	DIODE	1SS133
D6	1750000160	S. DIODE	DA114 T107
D7	1750000160	S. DIODE	DA114 T107
D8	1750000160	S. DIODE	DA114 T107

[LOGIC UNIT]

REF. NO.	ORDER NO.	DESCRIPTION	
D9	1750000160	S. DIODE	DA114 T107
D10	1750000160	S. DIODE	DA114 T107
D11	1750000160	S. DIODE	DA114 T107
D12	1750000160	S. DIODE	DA114 T107
D13	1750000160	S. DIODE	DA114 T107
D14	1750000160	S. DIODE	DA114 T107
D15	1750000160	S. DIODE	DA114 T107
D16	1750000160	S. DIODE	DA114 T107
D17	1750000160	S. DIODE	DA114 T107 (FRA)
X1	6050005760	XTAL	CR-276
L1	6180000960	COIL	LAL 03NA 102K
L2	6180000960	COIL	LAL 03NA 102K
L3	6910003570	COIL	2943-666663
L4	6910003570	COIL	2943-666663
L5	6910000670	COIL	BT01RN1-A61-001
R1	7030003640	S. RESISTOR	ERJ3GEYJ 473 V (47 kΩ)
R2	7030003680	S. RESISTOR	ERJ3GEYJ 104 V (100 kΩ)
R3	7030003640	S. RESISTOR	ERJ3GEYJ 473 V (47 kΩ)
R4	7030003640	S. RESISTOR	ERJ3GEYJ 473 V (47 kΩ)
R5	7030003560	S. RESISTOR	ERJ3GEYJ 103 V (100 kΩ)
R6	7030003680	S. RESISTOR	ERJ3GEYJ 104 V (100 kΩ)
R7	7030003680	S. RESISTOR	ERJ3GEYJ 104 V (100 kΩ)
R8	7010004670	RESISTOR	R50XJ 22 Ω
R9	7010004670	RESISTOR	R50XJ 22 Ω
R10	7030003560	S. RESISTOR	ERJ3GEYJ 103 V (10 kΩ)
R11	7030003570	S. RESISTOR	ERJ3GEYJ 123 V (12 kΩ)
R12	7030003440	S. RESISTOR	ERJ3GEYJ 102 V (1 kΩ)
R13	7030003680	S. RESISTOR	ERJ3GEYJ 104 V (100 kΩ)
R14	7030003640	S. RESISTOR	ERJ3GEYJ 473 V (47 kΩ)
R15	7030003640	S. RESISTOR	ERJ3GEYJ 473 V (47 kΩ)
R16	7030003520	S. RESISTOR	ERJ3GEYJ 472 V (4.7 kΩ)
R17	7510000310	THERMISTOR	ERT-D2ZHL 802S
R18	7030003560	S. RESISTOR	ERJ3GEYJ 103 V (10 kΩ)
R19	7310003250	TRIMMER	EVN-D2AA03 B33 (302)
R20	7030003680	S. RESISTOR	ERJ3GEYJ 104 V (100 kΩ)
R21	7030003720	S. RESISTOR	ERJ3GEYJ 224 V (220 kΩ)
R22	7030003680	S. RESISTOR	ERJ3GEYJ 104 V (100 kΩ)
R23	7030003800	S. RESISTOR	ERJ3GEYJ 105 V (1 MΩ)
R24	7030003580	S. RESISTOR	ERJ3GEYJ 153 V (15 kΩ)
R25	7030003600	S. RESISTOR	ERJ3GEYJ 223 V (22 kΩ)
R26	7030003680	S. RESISTOR	ERJ3GEYJ 104 V (100 kΩ)
R27	7030003720	S. RESISTOR	ERJ3GEYJ 224 V (220 kΩ)
R28	7030003680	S. RESISTOR	ERJ3GEYJ 104 V (100 kΩ)
R29	7030003800	S. RESISTOR	ERJ3GEYJ 105 V (1 MΩ)
R30	7030003580	S. RESISTOR	ERJ3GEYJ 153 V (15 kΩ)
R31	7030003560	S. RESISTOR	ERJ3GEYJ 103 V (10 kΩ)
R32	7030003840	S. RESISTOR	ERJ3GEYJ 225 V (2.2 MΩ)
R33	7030003560	S. RESISTOR	ERJ3GEYJ 103 V (10 kΩ)
R35	7030003640	S. RESISTOR	ERJ3GEYJ 473 V (47 kΩ)
R36	7030003660	S. RESISTOR	ERJ3GEYJ 683 V (68 kΩ)
R37	7030003560	S. RESISTOR	ERJ3GEYJ 103 V (10 kΩ)
R38	7030003800	S. RESISTOR	ERJ3GEYJ 105 V (1 MΩ)
R39	7030003640	S. RESISTOR	ERJ3GEYJ 473 V (47 kΩ)
R40	7030003640	S. RESISTOR	ERJ3GEYJ 473 V (47 kΩ)
R41	7030003640	S. RESISTOR	ERJ3GEYJ 473 V (47 kΩ)
R42	7030003640	S. RESISTOR	ERJ3GEYJ 473 V (47 kΩ)
R43	7030003640	S. RESISTOR	ERJ3GEYJ 473 V (47 kΩ)
R44	7030003640	S. RESISTOR	ERJ3GEYJ 473 V (47 kΩ)
R45	7030003640	S. RESISTOR	ERJ3GEYJ 473 V (47 kΩ)
R46	7030003640	S. RESISTOR	ERJ3GEYJ 473 V (47 kΩ)
R47	7030003640	S. RESISTOR	ERJ3GEYJ 473 V (47 kΩ)
R48	7030003640	S. RESISTOR	ERJ3GEYJ 473 V (47 kΩ)
R49	7030003640	S. RESISTOR	ERJ3GEYJ 473 V (47 kΩ)
R50	7030003640	S. RESISTOR	ERJ3GEYJ 473 V (47 kΩ)
R51	7030003640	S. RESISTOR	ERJ3GEYJ 473 V (47 kΩ)
R52	7030003440	S. RESISTOR	ERJ3GEYJ 102 V (1 kΩ)
R53	7030003440	S. RESISTOR	ERJ3GEYJ 102 V (1 kΩ)
R54	7030003440	S. RESISTOR	ERJ3GEYJ 102 V (1 kΩ)
R55	7030003440	S. RESISTOR	ERJ3GEYJ 102 V (1 kΩ)

S.=Surface mount

[LOGIC UNIT]

REF. NO.	ORDER NO.	DESCRIPTION	
R56	7030003440	S. RESISTOR	ERJ3GEYJ 102 V (1 kΩ)
R57	7030003440	S. RESISTOR	ERJ3GEYJ 102 V (1 kΩ)
R58	7030003440	S. RESISTOR	ERJ3GEYJ 102 V (1 kΩ)
R59	7030003440	S. RESISTOR	ERJ3GEYJ 102 V (1 kΩ)
R60	7030003440	S. RESISTOR	ERJ3GEYJ 102 V (1 kΩ)
R61	7030003440	S. RESISTOR	ERJ3GEYJ 102 V (1 kΩ)
R62	7030003440	S. RESISTOR	ERJ3GEYJ 102 V (1 kΩ)
R63	7030003440	S. RESISTOR	ERJ3GEYJ 102 V (1 kΩ)
R64	7030003440	S. RESISTOR	ERJ3GEYJ 102 V (1 kΩ)
R65	7030003440	S. RESISTOR	ERJ3GEYJ 102 V (1 kΩ)
R66	7030003440	S. RESISTOR	ERJ3GEYJ 102 V (1 kΩ)
R67	7030003440	S. RESISTOR	ERJ3GEYJ 102 V (1 kΩ)
R68	7030003440	S. RESISTOR	ERJ3GEYJ 102 V (1 kΩ)
R69	7030003440	S. RESISTOR	ERJ3GEYJ 102 V (1 kΩ)
R71	7030003440	S. RESISTOR	ERJ3GEYJ 102 V (1 kΩ)
R72	7030003440	S. RESISTOR	ERJ3GEYJ 102 V (1 kΩ)
R73	7030003440	S. RESISTOR	ERJ3GEYJ 102 V (1 kΩ)
R74	7030003440	S. RESISTOR	ERJ3GEYJ 102 V (1 kΩ)
R75	7030003440	S. RESISTOR	ERJ3GEYJ 102 V (1 kΩ)
R77	7030003440	S. RESISTOR	ERJ3GEYJ 102 V (1 kΩ)
R78	7030003440	S. RESISTOR	ERJ3GEYJ 102 V (1 kΩ)
R79	7030003440	S. RESISTOR	ERJ3GEYJ 102 V (1 kΩ)
R81	7030003440	S. RESISTOR	ERJ3GEYJ 102 V (1 kΩ)
R82	7030003440	S. RESISTOR	ERJ3GEYJ 102 V (1 kΩ)
R83	7030003440	S. RESISTOR	ERJ3GEYJ 102 V (1 kΩ)
R84	7030003440	S. RESISTOR	ERJ3GEYJ 102 V (1 kΩ)
R85	7030003440	S. RESISTOR	ERJ3GEYJ 102 V (1 kΩ)
R86	7030003440	S. RESISTOR	ERJ3GEYJ 102 V (1 kΩ)
R87	7030003440	S. RESISTOR	ERJ3GEYJ 102 V (1 kΩ)
R88	7030003440	S. RESISTOR	ERJ3GEYJ 102 V (1 kΩ)
R89	7030003440	S. RESISTOR	ERJ3GEYJ 102 V (1 kΩ)
R90	7030003440	S. RESISTOR	ERJ3GEYJ 102 V (1 kΩ)
R91	7030003440	S. RESISTOR	ERJ3GEYJ 102 V (1 kΩ)
R92	7030003560	S. RESISTOR	ERJ3GEYJ 103 V (10 kΩ)
R93	7030003640	S. RESISTOR	ERJ3GEYJ 473 V (47 kΩ)
R94	7030003480	S. RESISTOR	ERJ3GEYJ 222 V (2.2 kΩ)
R95	7030003400	S. RESISTOR	ERJ3GEYJ 471 V (470 Ω)
R96	7030003640	S. RESISTOR	ERJ3GEYJ 473 V (47 kΩ)
R97	7030003640	S. RESISTOR	ERJ3GEYJ 473 V (47 kΩ)
R98	7030003640	S. RESISTOR	ERJ3GEYJ 473 V (47 kΩ)
R99	7030003640	S. RESISTOR	ERJ3GEYJ 473 V (47 kΩ)
R100	7030003480	S. RESISTOR	ERJ3GEYJ 222 V (2.2 kΩ)
R101	7030003630	S. RESISTOR	ERJ3GEYJ 393 V (39 kΩ)
R102	7030003560	S. RESISTOR	ERJ3GEYJ 103 V (10 kΩ)
R103	7030003440	S. RESISTOR	ERJ3GEYJ 102 V (1 kΩ)
R104	7030003640	S. RESISTOR	ERJ3GEYJ 473 V (47 kΩ)
R105	7030003640	S. RESISTOR	ERJ3GEYJ 473 V (47 kΩ)
C1	4040000260	BARRIER	UZE 08X 104M
C2	4030006650	S. CERAMIC	C1608 SL 1H 200J-T-A
C3	4030006650	S. CERAMIC	C1608 SL 1H 200J-T-A
C4	4510003800	ELECTROLYTIC	25 MV 4R7 SW
C5	4030006880	S. CERAMIC	C1608 JB 1H 472K-T-A
C6	4510003800	ELECTROLYTIC	25 MV 4R7 SW
C7	4030006880	S. CERAMIC	C1608 JB 1H 472K-T-A
C8	4030008630	S. CERAMIC	C1608 JF 1C 104Z-T-A
C9	4030008630	S. CERAMIC	C1608 JF 1C 104Z-T-A
C10	4030006710	S. CERAMIC	C1608 SL 1H 470J-T-A
C11	4030008630	S. CERAMIC	C1608 JF 1C 104Z-T-A
C12	4030008630	S. CERAMIC	C1608 JF 1C 104Z-T-A
C13	4030006860	S. CERAMIC	C1608 JB 1H 102K-T-A
C14	4030006860	S. CERAMIC	C1608 JB 1H 102K-T-A
C15	4030006860	S. CERAMIC	C1608 JB 1H 102K-T-A
C16	4030006860	S. CERAMIC	C1608 JB 1H 102K-T-A
C17	4030006860	S. CERAMIC	C1608 JB 1H 102K-T-A
C18	4550000270	S. TANTALUM	TESVA 1E 474M1-8L
C19	4030008630	S. CERAMIC	C1608 JF 1C 104Z-T-A
C21	4030006880	S. CERAMIC	C1608 JB 1H 472K-T-A
C22	4030008630	S. CERAMIC	C1608 JF 1C 104Z-T-A
C23	4030006880	S. CERAMIC	C1608 JB 1H 472K-T-A
C24	4030006880	S. CERAMIC	C1608 JB 1H 472K-T-A
C25	4030006880	S. CERAMIC	C1608 JB 1H 472K-T-A
C26	4510004600	ELECTROLYTIC	16 MV 1000 HC
C27	4030006880	S. CERAMIC	C1608 JB 1H 472K-T-A

[LOGIC UNIT]

REF. NO.	ORDER NO.	DESCRIPTION	
C28	4030006880	S. CERAMIC	C1608 JB 1H 472K-T-A
C29	4030008630	S. CERAMIC	C1608 JF 1C 104Z-T-A
C30	4030008630	S. CERAMIC	C1608 JF 1C 104Z-T-A
C31	4030008630	S. CERAMIC	C1608 JF 1C 104Z-T-A
C32	4030008630	S. CERAMIC	C1608 JF 1C 104Z-T-A
C33	4030008630	S. CERAMIC	C1608 JF 1C 104Z-T-A
C34	4030008630	S. CERAMIC	C1608 JF 1C 104Z-T-A
C35	4030008630	S. CERAMIC	C1608 JF 1C 104Z-T-A
C36	4030006880	S. CERAMIC	C1608 JB 1H 472K-T-A
C38	4030006880	S. CERAMIC	C1608 JB 1H 472K-T-A
C39	4030006880	S. CERAMIC	C1608 JB 1H 472K-T-A
C40	4030006880	S. CERAMIC	C1608 JB 1H 472K-T-A
C41	4030006880	S. CERAMIC	C1608 JB 1H 472K-T-A
C43	4030008630	S. CERAMIC	C1608 JF 1C 104Z-T-A
BT1	3020000110	LITHIUM	CR2032
J1	6450000140	CONNECTOR	HSJ0807-01-010 [REMOTE]
J2	6510003390	CONNECTOR	B03B-EH-S
J3	6510007170	CONNECTOR	PI28A-03M
J4	6510007090	CONNECTOR	PI28A-04M
J5	6510011180	CONNECTOR	PI28A-14M
J7	6510007110	CONNECTOR	PI28A-10M
J12	6510008370	CONNECTOR	BBH-1
J13	6510010920	CONNECTOR	PI28A-11M
J14	2610000200	CONNECTOR	ICC05-028 360T
J15	6510001920	CONNECTOR	1490R [TUNER]
EP1	0910037284	PCB	B 3662D (LOGIC)
EP2	6910000600	BEAD	FSOH050RN

[PA PARTS]

REF. NO.	ORDER NO.	DESCRIPTION	
Q1	1520000290	TRANSISTOR	2SB1015-Y
SP1	2510000040	SPEAKER	C065K12I0810

[PA UNIT]

REF. NO.	ORDER NO.	DESCRIPTION	
Q1	1530000790	TRANSISTOR	2SC1971
Q2	1530000190	TRANSISTOR	2SC3133
Q3	1530000190	TRANSISTOR	2SC3133
Q4	1540000200	TRANSISTOR	2SD1406 Y
Q5	1530000200	TRANSISTOR	2SC2904
Q6	1530000200	TRANSISTOR	2SC2904
Q7	1520000060	TRANSISTOR	2SB562C
Q8	1590000340	TRANSISTOR	RN1202
D1	1790000710	VARISTOR	MA29B
D2	1790000710	VARISTOR	MA29B
D3	1790000710	VARISTOR	MA29B
D4	1710000010	DIODE	15CD11

S.=Surface mount

[PA UNIT]

REF. NO.	ORDER NO.	DESCRIPTION	
D5	1710000030	DIODE	1S1555
D6	1710000030	DIODE	1S1555
L1	6140001170	COIL	LR-142
L2	6910000670	COIL	BT01RN1-A61-001
L3	6910000670	COIL	BT01RN1-A61-001
L4	6140001300	COIL	LR-155
L5	6140000610	COIL	LR-83
L6	6140001310	COIL	LR-156
L7	6140002030	COIL	LR-230 (SK-10M-15Y 120)
L8	6180001230	COIL	LAL 04NA 8R2K
L9	6180001570	COIL	LAL 04NA 4R7K
L10	6910000670	COIL	BT01RN1-A61-001
L11	6910000670	COIL	BT01RN1-A61-001
L12	6180000880	COIL	LAL 03NA 100K
L13	6910000670	COIL	BT01RN1-A61-001
L14	6910000670	COIL	BT01RN1-A61-001
L15	6910000670	COIL	BT01RN1-A61-001
L16	6910000670	COIL	BT01RN1-A61-001
L17	6180000900	COIL	LAL 03NA 101K
L18	6180000900	COIL	LAL 03NA 101K
L19	6110001670	COIL	LA-253
R1	7010000310	RESISTOR	ELR25J 330 Ω
R2	7010001050	RESISTOR	R25XJ 150 Ω
R3	7010000290	RESISTOR	ELR25J 220 Ω
R4	7010000330	RESISTOR	ELR25J 470 Ω
R5	7010004830	RESISTOR	R50XJ 4.7 Ω
R6	7010004110	RESISTOR	R20J 220 Ω
R7	7010004720	RESISTOR	R50XJ 100 Ω
R8	7310003750	TRIMMER	EVN-2ACA00 B52 (501)
R9	7010000990	RESISTOR	R25XJ 47 Ω
R10	7010000990	RESISTOR	R25XJ 47 Ω
R11	7010004730	RESISTOR	R50XJ 120 Ω
R12	7010004730	RESISTOR	R50XJ 120 Ω
R13	7010004650	RESISTOR	R50XJ 10 Ω
R14	7080000650	RESISTOR	RSS1P 3R3 Ω
R15	7080000650	RESISTOR	RSS1P 3R3 Ω
R16	7080000650	RESISTOR	RSS1P 3R3 Ω
R17	7080000650	RESISTOR	RSS1P 3R3 Ω
R18	7010005240	RESISTOR	R50XJ 820 Ω
R19	7310003240	TRIMMER	EVN-2ACA00 B23 (202)
R20	7010004650	RESISTOR	R50XJ 10 Ω
R21	7010004650	RESISTOR	R50XJ 10 Ω
R22	7080000650	RESISTOR	RSS1P 3R3 Ω
R23	7080000650	RESISTOR	RSS1P 3R3 Ω
R24	7070000520	RESISTOR	CRH300 R-02J 2.7 Ω (2R7)
R25	7010000370	RESISTOR	ELR25J 1 kΩ
R26	7100000640	RESISTOR	5 SI 0.012 Ω (J)
R27	7010000370	RESISTOR	ELR25J 1 kΩ
R28	7010000990	RESISTOR	R25XJ 47 Ω
R29	7010004060	RESISTOR	R20J 82 Ω
R30	7010004190	RESISTOR	R20J 1 kΩ
R31	7010003490	RESISTOR	ELR20J 5.6 kΩ
R32	7510000070	THERMISTOR	ERT-D2FHL 503S
R33	7010003610	RESISTOR	ELR20J 39 kΩ
R35	7070000270	RESISTOR	CRH100X R-02J 100 Ω (101)
C1	4010000520	CERAMIC	DD108 B 472K 50V
C2	4010000510	CERAMIC	DD106 B 222K 50V
C3	4040000250	BARRIER	UAT 08X 473M
C4	4040000250	BARRIER	UAT 08X 473M
C5	4040000250	BARRIER	UAT 08X 473M
C6	4040000250	BARRIER	UAT 08X 473M
C7	4310000610	MYLER	50 F2D 472J
C8	4310000610	MYLER	50 F2D 472J
C9	4010000380	CERAMIC	DD107 SL 221J 50V
C10	4040000250	BARRIER	UAT 08X 473M
C11	4010000500	CERAMIC	DD104 B 102K 50V
C12	4030001370	S. CERAMIC	GR44 CH 682K
C13	4030001370	S. CERAMIC	GR44 CH 682K

[PA UNIT]

REF. NO.	ORDER NO.	DESCRIPTION	
C14	4040000250	BARRIER	UAT 08X 473M
C15	4040000250	BARRIER	UAT 08X 473M
C16	4510003880	ELECTROLYTIC	10 MV 47 HW
C17	4030001340	S. CERAMIC	GR44 CH 102K
C18	4010000420	CERAMIC	DD108 SL 391J 50V
C19	4010004070	CERAMIC	DD12 SL 221K 500V
C20	4320000220	DIP MICA	DM19C 681J5
C21	4030001340	S. CERAMIC	GR44 CH 102K
C22	4010004070	CERAMIC	DD12 SL 221K 500V
C23	4510003910	ELECTROLYTIC	16 MV 47 HW
C24	4010000520	CERAMIC	DD108 B 472K 50V
C25	4510004600	ELECTROLYTIC	16 MV 1000 HC
C26	4040000260	BARRIER	UZE 08X 104M
C27	4010000380	CERAMIC	DD107 SL 221J 50V
C28	4040000250	BARRIER	UAT 08X 473M
C29	4510004600	ELECTROLYTIC	16 MV 1000 HC
C30	4040000250	BARRIER	UAT 08X 473M
C31	4040000260	BARRIER	UZE 08X 104M
C32	4010000380	CERAMIC	DD107 SL 221J 50V
C33	4010000520	CERAMIC	DD108 B 472K 50V
C34	4510003790	ELECTROLYTIC	16 MV 10 SW
C35	4010000520	CERAMIC	DD108 B 472K 50V
C36	4510005000	ELECTROLYTIC	16 MV 220 HC
C37	4040000250	BARRIER	UAT 08X 473M
C38	4010000520	CERAMIC	DD108 B 472K 50V
C39	4010000520	CERAMIC	DD108 B 472K 50V
C40	4030001340	S. CERAMIC	GR44 CH 102K
C41	4510003910	ELECTROLYTIC	16 MV 47 HW
C42	4010000520	CERAMIC	DD108 B 472K 50V
C43	4010000520	CERAMIC	DD108 B 472K 50V
C44	4010000520	CERAMIC	DD108 B 472K 50V
S1	6910000060	THERMAL	OHD-3 90M
F1	5210000130	FUSE	FGB 4A
F2	5220000020	HOLDER	S-N5051
F3	5220000020	HOLDER	S-N5051
J1	6510003780	CONNECTOR	LLR-06 [DC13.8V]
J2	6510013150	CONNECTOR	SB3P-HVQ-B
J4	6510006790	CONNECTOR	TSL-P03P-V2
J5	6510006790	CONNECTOR	TSL-P03P-V2
J6	6510006790	CONNECTOR	TSL-P03P-V2
J7	6510006790	CONNECTOR	TSL-P03P-V2
J9	6510003080	CONNECTOR	RT01T-1.0B
J10	6510003080	CONNECTOR	RT01T-1.0B
J11	6510003390	CONNECTOR	B03B-EH-S
W6	7120000020	JUMPER	JPW 02H
EP1	6910000600	BEAD	FSOH050RN
EP2	6910000600	BEAD	FSOH050RN
EP3	6910000600	BEAD	FSOH050RN
EP4	6910000600	BEAD	FSOH050RN
EP5	6910000600	BEAD	FSOH050RN
EP6	6910000600	BEAD	FSOH050RN
EP13	0910035731	PCB	B 3370A (PA)
EP15	6910000600	BEAD	FSOH050RN
EP16	6910000600	BEAD	FSOH050RN
EP20	6910000630	BEAD	FSOH070RN
EP21	6910000630	BEAD	FSOH070RN

S.=Surface mount

[FILTER UNIT]

REF. NO.	ORDER NO.	DESCRIPTION	
D1	1790000070	DIODE	1SS237
D2	1790000070	DIODE	1SS237
D3	1710000030	DIODE	1S1555
D4	1710000030	DIODE	1S1555
D5	1710000030	DIODE	1S1555
D6	1710000030	DIODE	1S1555
D7	1710000030	DIODE	1S1555
D8	1710000030	DIODE	1S1555
D10	1790000070	DIODE	1SS237
L1	6140001990	COIL	LR-226
L2	6140002000	COIL	LR-227
L3	6140001780	COIL	LR-214
L4	6140001790	COIL	LR-215
L5	6140001800	COIL	LR-216
L6	6140001800	COIL	LR-216
L7	6140002010	COIL	LR-228
L8	6140001810	COIL	LR-217
L9	6140001810	COIL	LR-217
L10	6140002020	COIL	LR-229
L11	6110001490	COIL	LA-196
L12	6110001500	COIL	LA-197
L13	6180000900	COIL	LAL 03NA 101K
L14	6180000900	COIL	LAL 03NA 101K
L15	6180000900	COIL	LAL 03NA 101K
L16	6180000900	COIL	LAL 03NA 101K
L17	6180000900	COIL	LAL 03NA 101K
L18	6180000900	COIL	LAL 03NA 101K
L19	6180000900	COIL	LAL 03NA 101K
L20	6180000900	COIL	LAL 03NA 101K
L21	6180000880	COIL	LAL 03NA 100K
L22	6180000880	COIL	LAL 03NA 100K
L23	6180000880	COIL	LAL 03NA 100K
L24	6180000880	COIL	LAL 03NA 100K
L27	6140001340	COIL	LR-163
L28	6140001820	COIL	LR-218
R1	7010004020	RESISTOR	R20J 39 Ω
R2	7010004320	RESISTOR	R20J 10 kΩ
R3	7010003530	RESISTOR	ELR20J 10 kΩ
R4	7010003620	RESISTOR	ELR20J 47 kΩ
R6	7010003530	RESISTOR	ELR20J 10 kΩ
R7	7010003660	RESISTOR	ELR20J 100 kΩ
C1	4320000290	DIP MICA	DM20C 152J5
C2	4010004040	CERAMIC	DD10 SL 151K 500V
C3	4010004100	CERAMIC	DD14 SL 331K 500V
C5	4010004030	CERAMIC	DD10 SL 121K 500V
C6	4320000290	DIP MICA	DM20C 152J5
C7	4010004070	CERAMIC	DD12 SL 221K 500V
C8	4010004050	CERAMIC	DD12 SL 181K 500V
C9	4010004040	CERAMIC	DD10 SL 151K 500V
C10	4010004070	CERAMIC	DD12 SL 221K 500V
C12	4010003990	CERAMIC	DD09 SL 680K 500V
C13	4010004070	CERAMIC	DD12 SL 221K 500V
C14	4010004070	CERAMIC	DD12 SL 221K 500V
C15	4010004070	CERAMIC	DD12 SL 221K 500V
C16	4010004070	CERAMIC	DD12 SL 221K 500V
C17	4010004050	CERAMIC	DD12 SL 181K 500V
C18	4010004010	CERAMIC	DD09 SL 101K 500V
C19	4010004070	CERAMIC	DD12 SL 221K 500V
C20	4010004070	CERAMIC	DD12 SL 221K 500V
C21	4010004070	CERAMIC	DD12 SL 221K 500V
C22	4010003950	CERAMIC	DD06 SL 330K 500V
C23	4010004070	CERAMIC	DD12 SL 221K 500V
C24	4010004050	CERAMIC	DD12 SL 181K 500V
C25	4010004010	CERAMIC	DD09 SL 101K 500V
C28	4010004020	CERAMIC	DD09 SL 111K 500V
C29	4010004030	CERAMIC	DD10 SL 121K 500V
C30	4010004020	CERAMIC	DD09 SL 111K 500V
C31	4010004050	CERAMIC	DD12 SL 181K 500V
C32	4010004000	CERAMIC	DD09 SL 820K 500V

[FILTER UNIT]

REF. NO.	ORDER NO.	DESCRIPTION	
C33	4010003840	CERAMIC	DD06 SL 070D 500V
C34	4010004070	CERAMIC	DD12 SL 221K 500V
C35	4010003950	CERAMIC	DD06 SL 330K 500V
C36	4010004010	CERAMIC	DD09 SL 101K 500V
C37	4010003990	CERAMIC	DD09 SL 680K 500V
C38	4010003960	CERAMIC	DD06 SL 390K 500V
C39	4010004040	CERAMIC	DD10 SL 151K 500V
C40	4010003870	CERAMIC	DD06 SL 120K 500V
C41	4010003990	CERAMIC	DD09 SL 680K 500V
C42	4040000250	BARRIER	UAT 08X 473M
C43	4040000250	BARRIER	UAT 08X 473M
C44	4040000250	BARRIER	UAT 08X 473M
C45	4040000250	BARRIER	UAT 08X 473M
C46	4040000250	BARRIER	UAT 08X 473M
C47	4040000250	BARRIER	UAT 08X 473M
C48	4010000520	CERAMIC	DD108 B 472K 50V
C49	4010000520	CERAMIC	DD108 B 472K 50V
C50	4010000520	CERAMIC	DD108 B 472K 50V
C51	4010000520	CERAMIC	DD108 B 472K 50V
C52	4010000520	CERAMIC	DD108 B 472K 50V
C53	4010000520	CERAMIC	DD108 B 472K 50V
C54	4610001120	TRIMMER	CVSSC2001
C55	4010000410	CERAMIC	DD107 SL 331J 50V
C56	4010000410	CERAMIC	DD107 SL 331J 50V
C57	4010000430	CERAMIC	DD109 SL 471J 50V
C58	4010000430	CERAMIC	DD109 SL 471J 50V
C63	4010003960	CERAMIC	DD06 SL 390K 500V
C64	4010004030	CERAMIC	DD10 SL 121K 500V
C65	4010004050	CERAMIC	DD12 SL 181K 500V
C66	4010004090	CERAMIC	DD14 SL 301K 500V
C67	4010004090	CERAMIC	DD14 SL 301K 500V
C68	4010004090	CERAMIC	DD14 SL 301K 500V
C69	4010004090	CERAMIC	DD14 SL 301K 500V
C72	4010004070	CERAMIC	DD12 SL 221K 500V
C73	4010005290	CERAMIC	DD12 SL 621K 500V
C74	4010005290	CERAMIC	DD12 SL 621K 500V
C75	4010005290	CERAMIC	DD12 SL 621K 500V
C76	4010005290	CERAMIC	DD12 SL 621K 500V
RL1	6330000180	RELAY	MZ-12HG
RL2	6330000180	RELAY	MZ-12HG
RL3	6330000180	RELAY	MZ-12HG
RL4	6330000180	RELAY	MZ-12HG
RL5	6330000180	RELAY	MZ-12HG
RL6	6330000180	RELAY	MZ-12HG
RL7	6330000180	RELAY	MZ-12HG
RL8	6330000180	RELAY	MZ-12HG
RL9	6330000180	RELAY	MZ-12HG
RL10	6330000180	RELAY	MZ-12HG
RL11	6330000180	RELAY	MZ-12HG
RL12	6330000180	RELAY	MZ-12HG
J2	6510007020	CONNECTOR	TMP-J01X-V6
W7	7120000010	JUMPER	JPW 02A
W19	7120000010	JUMPER	JPW 02A
EP1	0910028622	PCB	B 2918B (FILTER)
EP2	6910000630	BEAD	FSOH070RN

[TUNER PARTS]

REF. NO.	ORDER NO.	DESCRIPTION	
C1	4040000250	BARRIER	UAT 08X 473M
C2	4040000250	BARRIER	UAT 08X 473M

[TUNE UNIT]

REF. NO.	ORDER NO.	DESCRIPTION	
D1	1710000030	DIODE	1S1555
D2	1710000030	DIODE	1S1555
D3	1710000030	DIODE	1S1555
D4	1710000030	DIODE	1S1555
D5	1710000030	DIODE	1S1555
D6	1710000030	DIODE	1S1555
L1	6110001220	COIL	LA-162
L2	6140002400	COIL	LR-269
L3	6140002390	COIL	LR-268
L4	6140001710	COIL	LR-187
C1	4620000100	VARIABLE	UV44B 300PF
C2	4620000100	VARIABLE	UV44B 300PF
RL1	6330000640	RELAY	OJE-SH-112DM
RL2	6330000640	RELAY	OJE-SH-112DM
RL3	6330000640	RELAY	OJE-SH-112DM
RL4	6330000640	RELAY	OJE-SH-112DM
RL5	6330000640	RELAY	OJE-SH-112DM
RL6	6330000640	RELAY	OJE-SH-112DM
EP1	0910033693	PCB	B 3386C (TUNE)
EP2	5610000060	CONNECTOR	P-423

[CTRL UNIT]

REF. NO.	ORDER NO.	DESCRIPTION	
IC1	1110000960	S. IC	NJM4558M (T1)
IC3	1120002251	S. IC	TC74ACT32F (TP1)
IC5	1120002241	S. IC	TC74AC112F (TP1)
IC6	1110002680	S. IC	NJM2902M-T1
IC7	1130001910	S. IC	μPD4011BG-T1
IC8	1130001910	S. IC	μPD4011BG-T1
IC9	1110001791	IC	TA7279P
IC10	1140000980	IC	μPD7533C-077
IC12	1120000970	IC	M54562P
IC13	1130006560	S. IC	μPD4063BG-T1
IC14	1130002660	S. IC	μPD4030BG-T1
IC16	1130004500	S. IC	TC4S11F (TE85R)
IC17	1180000620	IC	TA78L05S
IC18	1110000960	S. IC	NJM4558M (T1)

[CTRL UNIT]

REF. NO.	ORDER NO.	DESCRIPTION	
Q1	1560000620	FET	2SK937
Q2	1560000620	FET	2SK937
Q3	1590000460	S. TRANSISTOR	RN1402 (TE85R)
Q4	1560000040	FET	2SK30ATM-Y
Q5	1590000460	S. TRANSISTOR	RN1402 (TE85R)
Q7	1590000480	S. TRANSISTOR	RN2402 (TE85R)
Q8	1590000460	S. TRANSISTOR	RN1402 (TE85R)
Q9	1590000480	S. TRANSISTOR	RN2402 (TE85R)
Q10	1590000460	S. TRANSISTOR	RN1402 (TE85R)
Q11	1590000460	S. TRANSISTOR	RN1402 (TE85R)
Q12	1520000080	TRANSISTOR	2SB909M R
Q13	1530001950	S. TRANSISTOR	2SC2712-GR (TE85R)
Q19	1510000500	S. TRANSISTOR	2SA1162-GR (TE85R)
Q22	1510000500	S. TRANSISTOR	2SA1162-GR (TE85R)
Q23	1530001950	S. TRANSISTOR	2SC2712-GR (TE85R)
Q25	1530002020	S. TRANSISTOR	2SC3770-3-TA
Q26	1530002020	S. TRANSISTOR	2SC3770-3-TA
Q34	1590000460	S. TRANSISTOR	RN1402 (TE85R)
Q35	1590000460	S. TRANSISTOR	RN1402 (TE85R)
Q39	1530002550	S. TRANSISTOR	2SC3326-B (TE85R)
Q40	1590000480	S. TRANSISTOR	RN2402 (TE85R)
Q41	1590000410	S. TRANSISTOR	RN2404 (TE85R)
Q42	1590000480	S. TRANSISTOR	RN2402 (TE85R)
Q43	1590000460	S. TRANSISTOR	RN1402 (TE85R)
Q44	1590000480	S. TRANSISTOR	RN2402 (TE85R)
Q45	1590000460	S. TRANSISTOR	RN1402 (TE85R)
Q46	1590000420	S. TRANSISTOR	RN1404 (TE85R)
D1	1790000070	DIODE	1SS237
D2	1790000070	DIODE	1SS237
D6	1790000240	DIODE	1SS99
D7	1790000240	DIODE	1SS99
D8	1790000070	DIODE	1SS237
D9	1790000070	DIODE	1SS237
D10	1750000220	S. DIODE	DA113W T107
D11	1710000030	DIODE	1S1555
D12	1750000220	S. DIODE	DA113W T107
D13	1750000220	S. DIODE	DA113W T107
D14	1160000060	S. DIODE	DAN202U T107
D16	1710000030	DIODE	1S1555
D17	1730000410	S. ZENER	RD5.1M-T2B2
D18	1730000410	S. ZENER	RD5.1M-T2B2
D19	1750000220	S. DIODE	DA113W T107
D20	1160000050	S. DIODE	DAP202U T107
D21	1160000050	S. DIODE	DAP202U T107
D22	1750000220	S. DIODE	DA113W T107
D24	1160000050	S. DIODE	DAP202U T107
D27	1750000220	S. DIODE	DA113W T107
D28	1160000050	S. DIODE	DAP202U T107
D30	1750000220	S. DIODE	DA113W T107
D31	1730000730	S. ZENER	RD6.2M-T2B2
D34	1710000040	DIODE	1S953
D35	1710000030	DIODE	1S1555
D36	1160000050	S. DIODE	DAP202U T107
D39	1710000030	DIODE	1S1555
D40	1710000030	DIODE	1S1555
D41	1160000050	S. DIODE	DAP202U T107
D42	1160000050	S. DIODE	DAP202U T107
D43	1160000050	S. DIODE	DAP202U T107
D44	1160000060	S. DIODE	DAN202U T107
D45	1750000220	S. DIODE	DA113W T107
D47	1750000220	S. DIODE	DA113W T107
D48	1790000070	DIODE	1SS237
D49	1790000070	DIODE	1SS237
D50	1730000410	S. ZENER	RD5.1M-T2B2
D51	1750000220	S. DIODE	DA113W T107
D52	1160000060	S. DIODE	DAN202U T107
D53	1160000060	S. DIODE	DAN202U T107
D54	1160000050	S. DIODE	DAP202U T107
D55	1160000050	S. DIODE	DAP202U T107
D56	1160000050	S. DIODE	DAP202U T107
D57	1160000050	S. DIODE	DAP202U T107
D58	1160000050	S. DIODE	DAP202U T107
D59	1160000060	S. DIODE	DAN202U T107

S.=Surface mount

[CTRL UNIT]

REF. NO.	ORDER NO.	DESCRIPTION	
D60	1160000060	S. DIODE	DAN202U T107
D61	1160000050	S. DIODE	DAP202U T107
X1	6060000160	CERAMIC	CSB500E
L1	6140000100	COIL	LR-22A
L2	6180000450	COIL	RFC L6 222K
L3	6200001490	S. COIL	NL 322522T-101K
L4	6200001490	S. COIL	NL 322522T-101K
L5	6200001490	S. COIL	NL 322522T-101K
L7	6180000990	COIL	LAL 04NA 101K
L8	6200001490	S. COIL	NL 322522T-101K
L9	6200001490	S. COIL	NL 322522T-101K
L10	6140000090	COIL	LR-21
L12	6140000090	COIL	LR-21
L13	6180000450	COIL	RFC L6 222K
L15	6200001490	S. COIL	NL 322522T-101K
L16	6200001490	S. COIL	NL 322522T-101K
L17	6200001490	S. COIL	NL 322522T-101K
L18	6910000670	COIL	BT01RN1-A61-001
L20	6180000900	COIL	LAL 03NA 101K
L21	6200001490	S. COIL	NL 322522T-101K
L22	6200001490	S. COIL	NL 322522T-101K
L23	6200001490	S. COIL	NL 322522T-101K
L24	6200001490	S. COIL	NL 322522T-101K
L25	6200001490	S. COIL	NL 322522T-101K
R1	7030001110	S. RESISTOR	MCR50JZHJ 68 Ω (680)
R2	7030000500	S. RESISTOR	MCR10EZHJ 10 kΩ (103)
R3	7030000500	S. RESISTOR	MCR10EZHJ 10 kΩ (103)
R4	7030000580	S. RESISTOR	MCR10EZHJ 47 kΩ (473)
R5	7030000620	S. RESISTOR	MCR10EZHJ 100 kΩ (104)
R6	7030000660	S. RESISTOR	MCR10EZHJ 220 kΩ (224)
R7	7030000660	S. RESISTOR	MCR10EZHJ 220 kΩ (224)
R8	7030000640	S. RESISTOR	MCR10EZHJ 150 kΩ (154)
R9	7030000620	S. RESISTOR	MCR10EZHJ 100 kΩ (104)
R10	7030000660	S. RESISTOR	MCR10EZHJ 220 kΩ (224)
R11	7030000260	S. RESISTOR	MCR10EZHJ 100 Ω (101)
R16	7030000580	S. RESISTOR	MCR10EZHJ 47 kΩ (473)
R17	7030000660	S. RESISTOR	MCR10EZHJ 220 kΩ (224)
R18	7030000700	S. RESISTOR	MCR10EZHJ 220 kΩ (224)
R19	7030000260	S. RESISTOR	MCR10EZHJ 100 Ω (101)
R20	7030000620	S. RESISTOR	MCR10EZHJ 100 kΩ (104)
R21	7030000360	S. RESISTOR	MCR10EZHJ 680 Ω (681)
R22	7030000560	S. RESISTOR	MCR10EZHJ 33 kΩ (333)
R23	7030000340	S. RESISTOR	MCR10EZHJ 470 Ω (471)
R24	7310003170	TRIMMER	EVN-2ACA00 B53 (502)
R25	7030000460	S. RESISTOR	MCR10EZHJ 4.7 kΩ (472)
R26	7030000260	S. RESISTOR	MCR10EZHJ 100 Ω (101)
R27	7310003710	TRIMMER	EVN-2ACA00 B33 (302)
R29	7030000500	S. RESISTOR	MCR10EZHJ 10 kΩ (103)
R30	7030000460	S. RESISTOR	MCR10EZHJ 4.7 kΩ (472)
R31	7030000260	S. RESISTOR	MCR10EZHJ 100 Ω (101)
R32	7010004410	RESISTOR	R20J 47 kΩ
R33	7010004780	RESISTOR	R50XJ 470 Ω
R34	7010004780	RESISTOR	R50XJ 470 Ω
R35	7010001360	RESISTOR	R25XJ 47 kΩ
R36	7030001070	S. RESISTOR	MCR50JZHJ 33 Ω (330)
R37	7030000620	S. RESISTOR	MCR10EZHJ 100 kΩ (104)
R38	7030000560	S. RESISTOR	MCR10EZHJ 33 kΩ (333)
R39	7030000340	S. RESISTOR	MCR10EZHJ 470 Ω (471)
R40	7030000420	S. RESISTOR	MCR10EZHJ 2.2 kΩ (222)
R42	7030001070	S. RESISTOR	MCR50JZHJ 33 Ω (330)
R43	7030000500	S. RESISTOR	MCR10EZHJ 10 kΩ (103)
R44	7030000740	S. RESISTOR	MCR10EZHJ 1 MΩ (105)
R45	7030000500	S. RESISTOR	MCR10EZHJ 10 kΩ (103)
R46	7030000500	S. RESISTOR	MCR10EZHJ 10 kΩ (103)
R47	7030000460	S. RESISTOR	MCR10EZHJ 4.7 kΩ (472)
R48	7030000380	S. RESISTOR	MCR10EZHJ 1 kΩ (102)
R49	7030000420	S. RESISTOR	MCR10EZHJ 2.2 kΩ (222)
R50	7030002960	S. RESISTOR	MCR10EZHFX 100 kΩ (104)
R51	7310003200	TRIMMER	EVN-2ACA00 B14 (103)

[CTRL UNIT]

REF. NO.	ORDER NO.	DESCRIPTION	
R52	7030003060	S. RESISTOR	MCR10EZHFX 680 kΩ (684)
R53	7030000620	S. RESISTOR	MCR10EZHJ 100 kΩ (104)
R54	7010004450	RESISTOR	R20J 100 kΩ
R55	7030000720	S. RESISTOR	MCR10EZHJ 680 kΩ (684)
R56	7030000720	S. RESISTOR	MCR10EZHJ 680 kΩ (684)
R57	7030000580	S. RESISTOR	MCR10EZHJ 47 kΩ (473)
R59	7030000500	S. RESISTOR	MCR10EZHJ 10 kΩ (103)
R60	7030002960	S. RESISTOR	MCR10EZHFX 100 kΩ (104)
R61	7310003200	TRIMMER	EVN-2ACA00 B14 (103)
R62	7030003060	S. RESISTOR	MCR10EZHFX 680 kΩ (684)
R63	7030000620	S. RESISTOR	MCR10EZHJ 100 kΩ (104)
R64	7010004450	RESISTOR	R20J 100 kΩ
R66	7030000660	S. RESISTOR	MCR10EZHJ 220 kΩ (224)
R67	7030000590	S. RESISTOR	MCR10EZHJ 56 kΩ (563)
R68	7030000590	S. RESISTOR	MCR10EZHJ 56 kΩ (563)
R69	7030000380	S. RESISTOR	MCR10EZHJ 1 kΩ (102)
R70	7030000500	S. RESISTOR	MCR10EZHJ 10 kΩ (103)
R76	7030000580	S. RESISTOR	MCR10EZHJ 47 kΩ (473)
R77	7030000580	S. RESISTOR	MCR10EZHJ 47 kΩ (473)
R79	7030000380	S. RESISTOR	MCR10EZHJ 1 kΩ (102)
R84	7030000580	S. RESISTOR	MCR10EZHJ 47 kΩ (473)
R85	7030000580	S. RESISTOR	MCR10EZHJ 47 kΩ (473)
R87	7030000580	S. RESISTOR	MCR10EZHJ 47 kΩ (473)
R88	7030000580	S. RESISTOR	MCR10EZHJ 47 kΩ (473)
R91	7030000460	S. RESISTOR	MCR10EZHJ 4.7 kΩ (472)
R93	7030000460	S. RESISTOR	MCR10EZHJ 4.7 kΩ (472)
R95	7030000590	S. RESISTOR	MCR10EZHJ 56 kΩ (563)
R96	7030000420	S. RESISTOR	MCR10EZHJ 2.2 kΩ (222)
R97	7030000580	S. RESISTOR	MCR10EZHJ 47 kΩ (473)
R98	7030000460	S. RESISTOR	MCR10EZHJ 4.7 kΩ (472)
R99	7030000500	S. RESISTOR	MCR10EZHJ 10 kΩ (103)
R100	7510000310	THERMISTOR	ERT-D2ZHL 802S
R101	7030000580	S. RESISTOR	MCR10EZHJ 47 kΩ (473)
R102	7030000580	S. RESISTOR	MCR10EZHJ 47 kΩ (473)
R105	7030000360	S. RESISTOR	MCR10EZHJ 680 Ω (681)
R120	7030000580	S. RESISTOR	MCR10EZHJ 47 kΩ (473)
R121	7030000580	S. RESISTOR	MCR10EZHJ 47 kΩ (473)
R122	7030000580	S. RESISTOR	MCR10EZHJ 47 kΩ (473)
R123	7030000500	S. RESISTOR	MCR10EZHJ 10 kΩ (103)
R124	7030000300	S. RESISTOR	MCR10EZHJ 220 Ω (221)
R125	7030000460	S. RESISTOR	MCR10EZHJ 4.7 kΩ (472)
R133	7030000580	S. RESISTOR	MCR10EZHJ 47 kΩ (473)
R134	7030000580	S. RESISTOR	MCR10EZHJ 47 kΩ (473)
R135	7030000580	S. RESISTOR	MCR10EZHJ 47 kΩ (473)
R136	7030000580	S. RESISTOR	MCR10EZHJ 47 kΩ (473)
R137	7030000580	S. RESISTOR	MCR10EZHJ 47 kΩ (473)
R138	7030000580	S. RESISTOR	MCR10EZHJ 47 kΩ (473)
R139	7030000580	S. RESISTOR	MCR10EZHJ 47 kΩ (473)
R141	7030000220	S. RESISTOR	MCR10EZHJ 47 Ω (470)
R142	7030000220	S. RESISTOR	MCR10EZHJ 47 Ω (470)
R143	7030000580	S. RESISTOR	MCR10EZHJ 47 kΩ (473)
R144	7030000500	S. RESISTOR	MCR10EZHJ 10 kΩ (103)
R145	7030000500	S. RESISTOR	MCR10EZHJ 10 kΩ (103)
R146	7030000380	S. RESISTOR	MCR10EZHJ 1 kΩ (102)
R150	7030000380	S. RESISTOR	MCR10EZHJ 1 kΩ (102)
R151	7010001150	RESISTOR	R25XJ 1 kΩ
R152	7030000380	S. RESISTOR	MCR10EZHJ 1 kΩ (102)
R153	7030000380	S. RESISTOR	MCR10EZHJ 1 kΩ (102)
R154	7030000380	S. RESISTOR	MCR10EZHJ 1 kΩ (102)
R155	7030000380	S. RESISTOR	MCR10EZHJ 1 kΩ (102)
R156	7030000380	S. RESISTOR	MCR10EZHJ 1 kΩ (102)
R157	7030000380	S. RESISTOR	MCR10EZHJ 1 kΩ (102)
R158	7030000380	S. RESISTOR	MCR10EZHJ 1 kΩ (102)
R159	7030000380	S. RESISTOR	MCR10EZHJ 1 kΩ (102)
R160	7030000220	S. RESISTOR	MCR10EZHJ 47 Ω (470)
R161	7030000210	S. RESISTOR	MCR10EZHJ 39 Ω (390)
R162	7010004680	RESISTOR	R50XJ 33 Ω
R163	7030000660	S. RESISTOR	MCR10EZHJ 220 kΩ (224)
R164	7030000440	S. RESISTOR	MCR10EZHJ 3.3 kΩ (332)
R166	7030000680	S. RESISTOR	MCR10EZHJ 330 kΩ (334)
R167	7030000700	S. RESISTOR	MCR10EZHJ 470 kΩ (474)
R168	7030000680	S. RESISTOR	MCR10EZHJ 330 kΩ (334)
R170	7030000700	S. RESISTOR	MCR10EZHJ 470 kΩ (474)
R171	7030003890	S. RESISTOR	MCR10EZHFX 1 MΩ (105)
R172	7030004640	S. RESISTOR	MCR10EZHFX 432 kΩ

S.=Surface mount

[CTRL UNIT]

REF. NO.	ORDER NO.	DESCRIPTION	
R173	7030000220	S. RESISTOR	MCR10EZHZ 47 Ω (470)
R174	7030000220	S. RESISTOR	MCR10EZHZ 47 Ω (470)
R175	7030000460	S. RESISTOR	MCR10EZHZ 4.7 kΩ (472)
R176	7030000500	S. RESISTOR	MCR10EZHZ 10 kΩ (103)
R177	7030000560	S. RESISTOR	MCR10EZHZ 33 kΩ (333)
R178	7030000620	S. RESISTOR	MCR10EZHZ 100 kΩ (104)
C1	4030004630	S. CERAMIC	C2012 SL 1H 151J-T-A
C2	4030004720	S. CERAMIC	C2012 JB 1H 102K-T-A
C11	4610001120	TRIMMER	CVSSC2001
C12	4030004720	S. CERAMIC	C2012 JB 1H 102K-T-A
C13	4510003790	ELECTROLYTIC	16 MV 10 SW
C14	4510003790	ELECTROLYTIC	16 MV 10 SW
C15	4030005110	S. CERAMIC	C2012 JB 1E 473K-T-A
C16	4030005110	S. CERAMIC	C2012 JB 1E 473K-T-A
C17	4610001000	TRIMMER	CVSSA0701
C18	4010004000	CERAMIC	DD09 SL 820K 500V
C19	4030004750	S. CERAMIC	C2012 JB 1H 103K-T-A
C20	4030004750	S. CERAMIC	C2012 JB 1H 103K-T-A
C21	4510004990	ELECTROLYTIC	16 MV 100 HC
C22	4030004660	S. CERAMIC	C2012 SL 1H 221J-T-A
C23	4030004760	S. CERAMIC	C2012 JF 1E 104Z-T-A
C24	4510003910	ELECTROLYTIC	16 MV 47 HW
C25	4030005110	S. CERAMIC	C2012 JB 1E 473K-T-A
C26	4030004740	S. CERAMIC	C2012 JB 1H 472K-T-A
C27	4510003790	ELECTROLYTIC	16 MV 10 SW
C29	4030004760	S. CERAMIC	C2012 JF 1E 104Z-T-A
C30	4030004760	S. CERAMIC	C2012 JF 1E 104Z-T-A
C31	4030004750	S. CERAMIC	C2012 JB 1H 103K-T-A
C32	4030004750	S. CERAMIC	C2012 JB 1H 103K-T-A
C33	4030004660	S. CERAMIC	C2012 SL 1H 221J-T-A
C34	4030004740	S. CERAMIC	C2012 JB 1H 472K-T-A
C36	4010003800	CERAMIC	DD06 SL 030C 500V
C37	4030004580	S. CERAMIC	C2012 SL 1H 560J-T-A
C38	4610000480	TRIMMER	BW 3P 210P
C39	4030004740	S. CERAMIC	C2012 JB 1H 472K-T-A
C40	4030004740	S. CERAMIC	C2012 JB 1H 472K-T-A
C41	4030004720	S. CERAMIC	C2012 JB 1H 102K-T-A
C42	4030004740	S. CERAMIC	C2012 JB 1H 472K-T-A
C43	4030004740	S. CERAMIC	C2012 JB 1H 472K-T-A
C44	4030005110	S. CERAMIC	C2012 JB 1E 473K-T-A
C45	4030004660	S. CERAMIC	C2012 SL 1H 221J-T-A
C46	4030004710	S. CERAMIC	C2012 JB 1H 471K-T-A
C47	4030005110	S. CERAMIC	C2012 JB 1E 473K-T-A
C49	4030004760	S. CERAMIC	C2012 JF 1E 104Z-T-A
C50	4030004760	S. CERAMIC	C2012 JF 1E 104Z-T-A
C51	4030005110	S. CERAMIC	C2012 JB 1E 473K-T-A
C52	4030005110	S. CERAMIC	C2012 JB 1E 473K-T-A
C53	4030005110	S. CERAMIC	C2012 JB 1E 473K-T-A
C54	4030004660	S. CERAMIC	C2012 SL 1H 221J-T-A
C55	4030004710	S. CERAMIC	C2012 JB 1H 471K-T-A
C56	4030004740	S. CERAMIC	C2012 JB 1H 472K-T-A
C57	4030004740	S. CERAMIC	C2012 JB 1H 472K-T-A
C58	4510005000	ELECTROLYTIC	16 MV 220 HC
C59	4030004740	S. CERAMIC	C2012 JB 1H 472K-T-A
C60	4030005110	S. CERAMIC	C2012 JB 1E 473K-T-A
C61	4510003850	ELECTROLYTIC	50 MV 2R2 SW
C62	4510003850	ELECTROLYTIC	50 MV 2R2 SW
C63	4030004660	S. CERAMIC	C2012 SL 1H 221J-T-A
C64	4030004660	S. CERAMIC	C2012 SL 1H 221J-T-A
C67	4030005110	S. CERAMIC	C2012 JB 1E 473K-T-A
C68	4510004990	ELECTROLYTIC	16 MV 100 HC
C69	4030004740	S. CERAMIC	C2012 JB 1H 472K-T-A
C75	4030004760	S. CERAMIC	C2012 JF 1E 104Z-T-A
C76	4030004740	S. CERAMIC	C2012 JB 1H 472K-T-A
C77	4030004760	S. CERAMIC	C2012 JF 1E 104Z-T-A
C80	4030005110	S. CERAMIC	C2012 JB 1E 473K-T-A
C81	4030005110	S. CERAMIC	C2012 JB 1E 473K-T-A
C83	4030004760	S. CERAMIC	C2012 JF 1E 104Z-T-A
C84	4030004760	S. CERAMIC	C2012 JF 1E 104Z-T-A
C85	4030004760	S. CERAMIC	C2012 JF 1E 104Z-T-A
C86	4030004760	S. CERAMIC	C2012 JF 1E 104Z-T-A
C87	4030004760	S. CERAMIC	C2012 JF 1E 104Z-T-A
C88	4010004010	CERAMIC	DD09 SL 101K 500V

[CTRL UNIT]

REF. NO.	ORDER NO.	DESCRIPTION	
C89	4030004760	S. CERAMIC	C2012 JF 1E 104Z-T-A
C90	4030004760	S. CERAMIC	C2012 JF 1E 104Z-T-A
C91	4030004760	S. CERAMIC	C2012 JF 1E 104Z-T-A
C92	4030004760	S. CERAMIC	C2012 JF 1E 104Z-T-A
C93	4030004760	S. CERAMIC	C2012 JF 1E 104Z-T-A
C94	4030004720	S. CERAMIC	C2012 JB 1H 102K-T-A
C95	4030004760	S. CERAMIC	C2012 JF 1E 104Z-T-A
C96	4030004720	S. CERAMIC	C2012 JB 1H 102K-T-A
C97	4030004720	S. CERAMIC	C2012 JB 1H 102K-T-A
C98	4030004760	S. CERAMIC	C2012 JF 1E 104Z-T-A
C99	4030004760	S. CERAMIC	C2012 JF 1E 104Z-T-A
C100	4030004760	S. CERAMIC	C2012 JF 1E 104Z-T-A
C101	4030004760	S. CERAMIC	C2012 JF 1E 104Z-T-A
C102	4030004760	S. CERAMIC	C2012 JF 1E 104Z-T-A
C103	4030004760	S. CERAMIC	C2012 JF 1E 104Z-T-A
C109	4030004760	S. CERAMIC	C2012 JF 1E 104Z-T-A
C110	4010003860	CERAMIC	DD06 SL 100D 500V
C111	4510003790	ELECTROLYTIC	16 MV 10 SW
C112	4030004740	S. CERAMIC	C2012 JB 1H 472K-T-A
C113	4510004990	ELECTROLYTIC	16 MV 100 HC
C114	4030004740	S. CERAMIC	C2012 JB 1H 472K-T-A
C115	4510004910	ELECTROLYTIC	16 MV 10 SWNP
C120	4030004760	S. CERAMIC	C2012 JF 1E 104Z-T-A
C121	4030004760	S. CERAMIC	C2012 JF 1E 104Z-T-A
C122	4030004760	S. CERAMIC	C2012 JF 1E 104Z-T-A
C123	4030004760	S. CERAMIC	C2012 JF 1E 104Z-T-A
C124	4030004760	S. CERAMIC	C2012 JF 1E 104Z-T-A
C125	4030004760	S. CERAMIC	C2012 JF 1E 104Z-T-A
C126	4030004760	S. CERAMIC	C2012 JF 1E 104Z-T-A
C127	4030004760	S. CERAMIC	C2012 JF 1E 104Z-T-A
C128	4030004760	S. CERAMIC	C2012 JF 1E 104Z-T-A
C129	4030004760	S. CERAMIC	C2012 JF 1E 104Z-T-A
C130	4510003790	ELECTROLYTIC	16 MV 10 SW
C131	4030004760	S. CERAMIC	C2012 JF 1E 104Z-T-A
C132	4510004590	ELECTROLYTIC	16 MV 470 HC
C133	4030004760	S. CERAMIC	C2012 JF 1E 104Z-T-A
C134	4030004740	S. CERAMIC	C2012 JB 1H 472K-T-A
C135	4030004740	S. CERAMIC	C2012 JB 1H 472K-T-A
C136	4030004740	S. CERAMIC	C2012 JB 1H 472K-T-A
C137	4030004740	S. CERAMIC	C2012 JB 1H 472K-T-A
C138	4030004740	S. CERAMIC	C2012 JB 1H 472K-T-A
C139	4030004740	S. CERAMIC	C2012 JB 1H 472K-T-A
C140	4010003790	CERAMIC	DD06 SL 020C 500V
C141	4030005110	S. CERAMIC	C2012 JB 1E 473K-T-A
C142	4030005110	S. CERAMIC	C2012 JB 1E 473K-T-A
C143	4030005110	S. CERAMIC	C2012 JB 1E 473K-T-A
C144	4030005110	S. CERAMIC	C2012 JB 1E 473K-T-A
C145	4510003840	ELECTROLYTIC	50 MV 1 SW
BT1	3020000020	LITHIUM	BR2032-1T2
RL1	6330000890	RELAY	FX-12
RL2	6330000890	RELAY	FX-12
RL3	6330000830	RELAY	JY-12H-K-DW
J1	6510007020	CONNECTOR	TMP-J01X-V6
J2	6510003390	CONNECTOR	B03B-EH-S
J3	6510003400	CONNECTOR	B04B-EH-S
J4	6510003400	CONNECTOR	B04B-EH-S
J5	6510003390	CONNECTOR	B03B-EH-S
J7	6510003430	CONNECTOR	B07B-EH-S
J8	6510003390	CONNECTOR	B03B-EH-S
J14	6510003080	CONNECTOR	RT01T-1.0B
J15	6510003390	CONNECTOR	B03B-EH-S
J16	6510003400	CONNECTOR	B04B-EH-S
J17	6510003440	CONNECTOR	B08B-EH-S
J18	6510003440	CONNECTOR	B08B-EH-S
J19	6510007020	CONNECTOR	TMP-J01X-V6
J20	6510003250	CONNECTOR	TMP-J01X-A2
W1	7120000010	JUMPER	JPW 02A

S.=Surface mount

[CTRL UNIT]

REF. NO.	ORDER NO.	DESCRIPTION	
W2	712000010	JUMPER	JPW 02A
W3	712000010	JUMPER	JPW 02A
W4	712000010	JUMPER	JPW 02A
W6	712000010	JUMPER	JPW 02A
W25	712000010	JUMPER	JPW 02A
W26	712000020	JUMPER	JPW 02H
W27	703000010	S. JUMPER	MCR10EZHZ JPW (000)
EP1	0910037584	PCB	B 3668D (CTRL)

[SWR BOARD]

REF. NO.	ORDER NO.	DESCRIPTION	
IC1	1110000960	S. IC	NJM4558M (T1)
IC2	1110000960	S. IC	NJM4558M (T1)
Q1	1560000360	S. FET	2SK209-Y (TE85R)
Q2	1560000360	S. FET	2SK209-Y (TE85R)
D1	1750000030	S. DIODE	1SS187 (TE85R)
R1	7030000620	S. RESISTOR	MCR10EZHZ 100 kΩ (104)
R2	7030000500	S. RESISTOR	MCR10EZHZ 10 kΩ (103)
R3	7030000500	S. RESISTOR	MCR10EZHZ 10 kΩ (103)
R4	7030000500	S. RESISTOR	MCR10EZHZ 10 kΩ (103)
R5	7030000600	S. RESISTOR	MCR10EZHZ 68 kΩ (683)
R6	7030000570	S. RESISTOR	MCR10EZHZ 39 kΩ (393)
R7	7030000580	S. RESISTOR	MCR10EZHZ 47 kΩ (473)
R8	7030000580	S. RESISTOR	MCR10EZHZ 47 kΩ (473)
R9	7030000540	S. RESISTOR	MCR10EZHZ 22 kΩ (223)
R10	7030000620	S. RESISTOR	MCR10EZHZ 100 kΩ (104)
R11	7030000500	S. RESISTOR	MCR10EZHZ 10 kΩ (103)
R12	7030000500	S. RESISTOR	MCR10EZHZ 10 kΩ (103)
R13	7030000630	S. RESISTOR	MCR10EZHZ 120 kΩ (124)
R14	7030000500	S. RESISTOR	MCR10EZHZ 10 kΩ (103)
R15	7030000480	S. RESISTOR	MCR10EZHZ 6.8 kΩ (682)
R16	7030000500	S. RESISTOR	MCR10EZHZ 10 kΩ (103)
R17	7030000570	S. RESISTOR	MCR10EZHZ 39 kΩ (393)
R18	7030000740	S. RESISTOR	MCR10EZHZ 1 MΩ (105)
R19	7030000570	S. RESISTOR	MCR10EZHZ 39 kΩ (393)
C1	4030005110	S. CERAMIC	C2012 JB 1E 473K-T-A
C2	4030004750	S. CERAMIC	C2012 JB 1H 103K-T-A
C3	4030005110	S. CERAMIC	C2012 JB 1E 473K-T-A
C4	4030005110	S. CERAMIC	C2012 JB 1E 473K-T-A
C5	4030005110	S. CERAMIC	C2012 JB 1E 473K-T-A
C6	4030004710	S. CERAMIC	C2012 JB 1H 471K-T-A
C7	4030008670	S. CERAMIC	C2012 JB 1H 562K-T-A
J1	6510006670	CONNECTOR	50002-8104
J2	6510006660	CONNECTOR	50002-8103
EP1	0910014862	PCB	B 1332B (SWR)

[VR-D UNIT]

REF. NO.	ORDER NO.	DESCRIPTION	
R1	7210001860	VARIABLE	EVU-F2AF20 B14 (10KB)
EP1	0910037591	PCB	B 3673A (VR-D)

[VR-E UNIT]

REF. NO.	ORDER NO.	DESCRIPTION	
R1	7210001860	VARIABLE	EVU-F2AF20 B14 (10KB)
EP1	0910037601	PCB	B 3734A (VR-E)

[ANT-SW UNIT]

REF. NO.	ORDER NO.	DESCRIPTION	
D1	1710000030	DIODE	1S1555
D2	1710000030	DIODE	1S1555
L1	6140001460	COIL	LR-170
L2	6140001460	COIL	LR-170
L3	6180000880	COIL	LAL 03NA 100K
L4	6180000880	COIL	LAL 03NA 100K
R1	7540000010	ABSORBER	DSA-301LA
C1	4010000330	CERAMIC	DD105 SL 101J 50V
C2	4010000120	CERAMIC	DD104 SL 100D 50V
C3	4010000370	CERAMIC	DD106 SL 201J 50V
C4	4010000120	CERAMIC	DD104 SL 100D 50V
C5	4010000330	CERAMIC	DD105 SL 101J 50V
C6	4010000520	CERAMIC	DD108 B 472K 50V
C7	4010000520	CERAMIC	DD108 B 472K 50V
RL1	6330000470	RELAY	NR-HD (12V) AE5343
RL2	6330000800	RELAY	G5A-237P DC12V
J4	6510000410	CONNECTOR	MR-DS-E 02 [ANT2]
J5	6510000410	CONNECTOR	MR-DS-E 02 [ANT1]
W1	7120000380	JUMPER	JPW 01 R-01
W2	7120000380	JUMPER	JPW 01 R-01
W3	7120000380	JUMPER	JPW 01 R-01
W4	7120000380	JUMPER	JPW 01 R-01
W5	7120000380	JUMPER	JPW 01 R-01
W6	7120000380	JUMPER	JPW 01 R-01
EP1	0910037255	PCB	B 3669E (ANT-SW)

S.=Surface mount

[ELEKEY UNIT]

REF. NO.	ORDER NO.	DESCRIPTION	
IC1	1140000400	IC	μPD7564CS-031
Q1	1590000350	TRANSISTOR	RN1204
D1	1730000100	ZENER	RD5.1E B2
X1	6060000160	CERAMIC	CSB500E
R1	7010004270	RESISTOR	R20J 4.7 kΩ
R2	7010004270	RESISTOR	R20J 4.7 kΩ
R3	7010004190	RESISTOR	R20J 1 kΩ
R4	7010004320	RESISTOR	R20J 10 kΩ
R5	7010004150	RESISTOR	R20J 470 Ω
R6	7010004250	RESISTOR	R20J 3.3 kΩ
R7	7010004300	RESISTOR	R20J 6.8 kΩ
R8	7310000790	TRIMMER	RH0651C15J1UA (104)
C1	4310000480	MYLER	50 F2D 104J
C2	4310000610	MYLER	50 F2D 472J
C3	4010000520	CERAMIC	DD108 B 472K 50V
C4	4510003790	ELECTROLYTIC	16 MV 10 SW
C5	4010000330	CERAMIC	DD105 SL 101J 50V
C6	4010000330	CERAMIC	DD105 SL 101J 50V
C7	4510003850	ELECTROLYTIC	50 MV 2R2 SW
J2	6510003400	CONNECTOR	B04B-EH-S
EP1	0910012511	PCB	B 1128A (ELEKEY)

SECTION 7 MECHANICAL PARTS

7-1 FRONT AND CABINET PARTS

LABEL NUMBER	ORDER NO.	DESCRIPTION	QTY.	LABEL NUMBER	ORDER NO.	DESCRIPTION	QTY.
①	8210008431	1296 front panel (A) -1 complete (incl. ⑳-㉓)	1	④①	6510000190	Connector FM214-8SS (P) [MICROPHONE] (incl. nut)	1
②	8810000990	Screw PH B0 M2 × 5	9	④②	7210001990	Variable resistor RV-233 (RK1242210) 10KB/10KA [SQL/AF] (incl. nut, washer)	1
③	8610008440	Button spacer for K201	1				
④	8930027110	Push spring (P)	1				
⑤	8930027960	1296 push spring	3	④③	7210002270	Variable resistor RV-279 (RK1242210) 250KC/10KB [KEY SPEED/MIC] (incl. nut, washer)	1
⑥	8930027120	1296 knob plate	1				
⑦	8610008420	Button K201 [POWER]	1				
⑧	8610008430	Button K202 [TRANSMIT]	1	④④	2250000110	Encoder SW-147 (EC24B50B) [MAIN DIAL] (incl. nut, washer)	1
⑨	8210008120	1296 front glass	1				
⑩	8610008450	Knob cover for N96	1				
⑪	8610008570	Knob N96 (A) assembly [MAIN DIAL]	1	④⑤	7210002300	Variable resistor RV-282 (RK0971110) 10KB [PBT] (incl. nut, washer)	1
⑫	8610008410	Button K200 [BK-IN, FULL]	2				
⑬	8610008500	Knob N69 (A) [AF, MIC]	2				
⑭	8610008510	Knob N45 (D) [SQL, KEY SPEED]	2	④⑥	7210002280	Variable resistor RV-281 (RK0971110) 10KB [RIT/ΔTX] (incl. nut, washer)	1
⑮	8930027460	1296 knob sheet	1				
⑯	8930027470	1296 brake pad	1				
⑰	8930027090	1296 brake plate	1	④⑦	7210002290	Variable resistor RV-280 (RK0971110) 100KC [NOTCH] (incl. nut, washer)	1
⑱	8810007750	Screw PH B1 M3 × 18 ZK	1				
⑲	8820000770	1296 screw	1				
⑳	8850001330	Insulate flat washer (M)	1	④⑧	8930027140	1296 LCD rubber	1
㉑	8610008470	Knob N113 (C) [M-CH]	1				
㉒	8610008460	Knob N113 (B) [PBT, NOTCH, etc.]	3				
㉓	8810002260	Screw FH B0 M3 × 6	8	④⑨	5030000910	LCD FTD-11668AAPH [FUNCTION DISPLAY]	1
㉔	8610008390	Button K-198 [TUNER, TUNE, etc.]	1				
㉕	8610008370	Button K-196 [SSB, CW/N, etc.]	1				
㉖	8610008380	Button K-197 [XFC, TS, etc.]	1	④⑩	8930027390	1296 A-LCD filter (A)	1
㉗	8610008340	Button K-193 [SEL, SCAN, etc.]	2				
㉘	8930027330	1296 meter sponge	1				
㉙	5510000400	Meter ME-32 (MG-113S) [S/RF METER]	1	④⑪	8930027040	1296 LCD holder	1
㉚	8010002990	Meter holder	1	④⑬	8810001350	Screw PH B1 M3 × 6	8
㉛	8810004010	Screw PH B0 M2 × 8	21	④⑭	8810000010	Screw PH M2 × 4	1
㉜	8810003160	Setscrew A M3 × 6	2	④⑮	8810004320	Screw OH M3 × 8 ZK BS	19
㉝	6450001230	Snap plate HLJ0999-01-480	1	④⑯	8110004960	1296 top cover (complete)	1
㉞	8930003200	Spacer (P)	1	④⑰	8110004970	1296 bottom cover (complete)	1
㉟	8950002970	1296 bushings nut	1	④⑱	6510000410	Connector MR-DS-E 02 [ANT1, ANT2]	2
㊱	8010014221	1296 sub chassis	1				
㊲	8810002250	Screw FH B0 M2.6 × 6	2	④⑲	8930027350	1296 ANT plate	1
㊳	2260001580	Switch JP22120-0101 (TV-3) [POWER]	1	④⑳	8810006070	Setscrew A M3 × 6 NI	2
㊴	6450000191	Connector HLJ4815-01-030 [PHONES]	1	④㉒	8810002910	Screw BiH M3 × 8 NI BS	4
㊵				④㉔	8850000420	Spring washer M3 NI	2
㊶				④㉖	8860000040	Rivet M2 × 6 No.2 NI (FRA)	2
㊷				④㉘	8850000440	Spring washer M5 NI	1
㊸				④㉚	8830000360	Wing nut M5 NI	1

Screw abbreviations PH: Pan head FH: Flat head OH: Oval countersunk head BiH: Binding head
B0, B1, ST: Self-tapping BS: Brass NI: Nickel ZK: Black

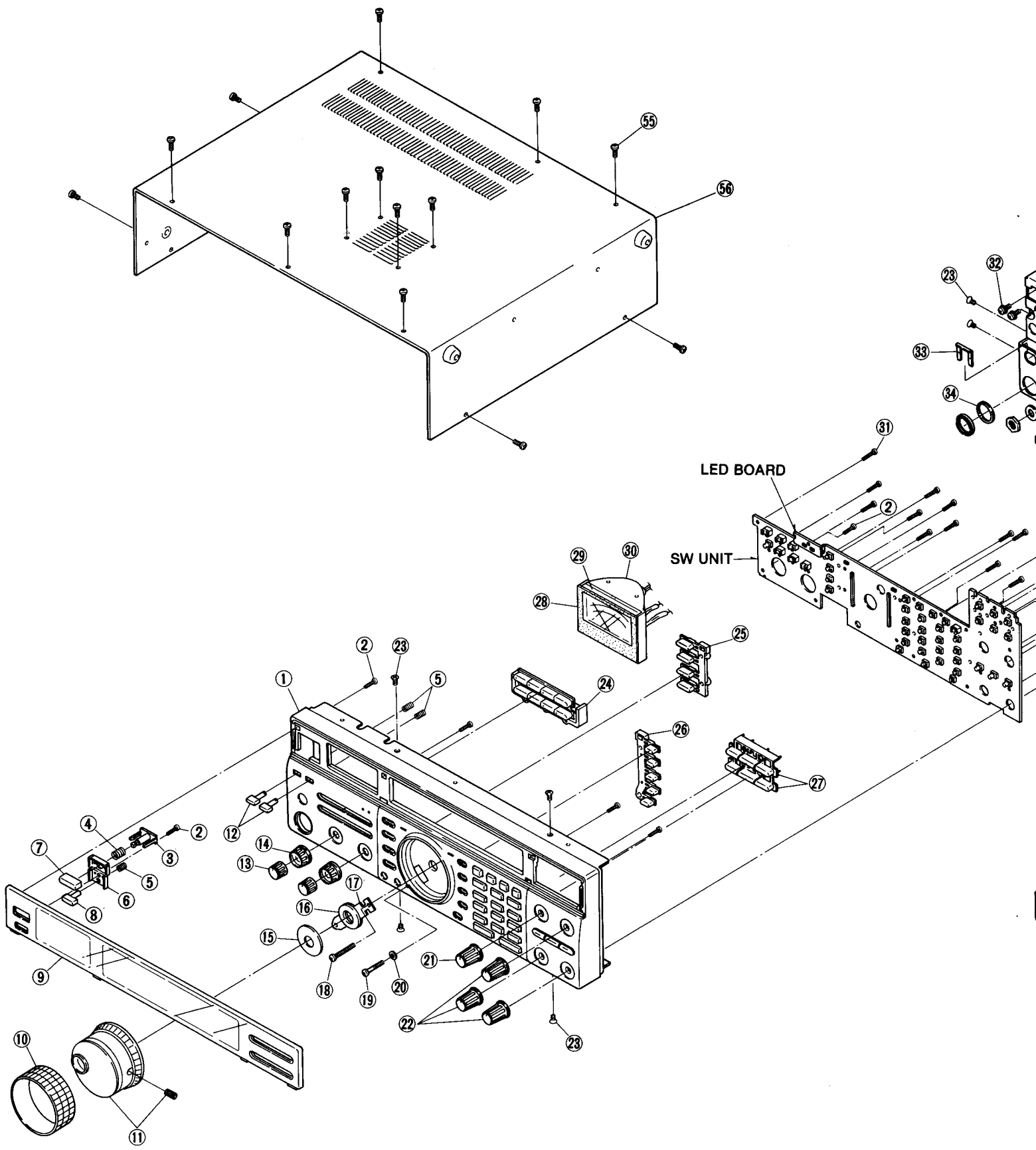

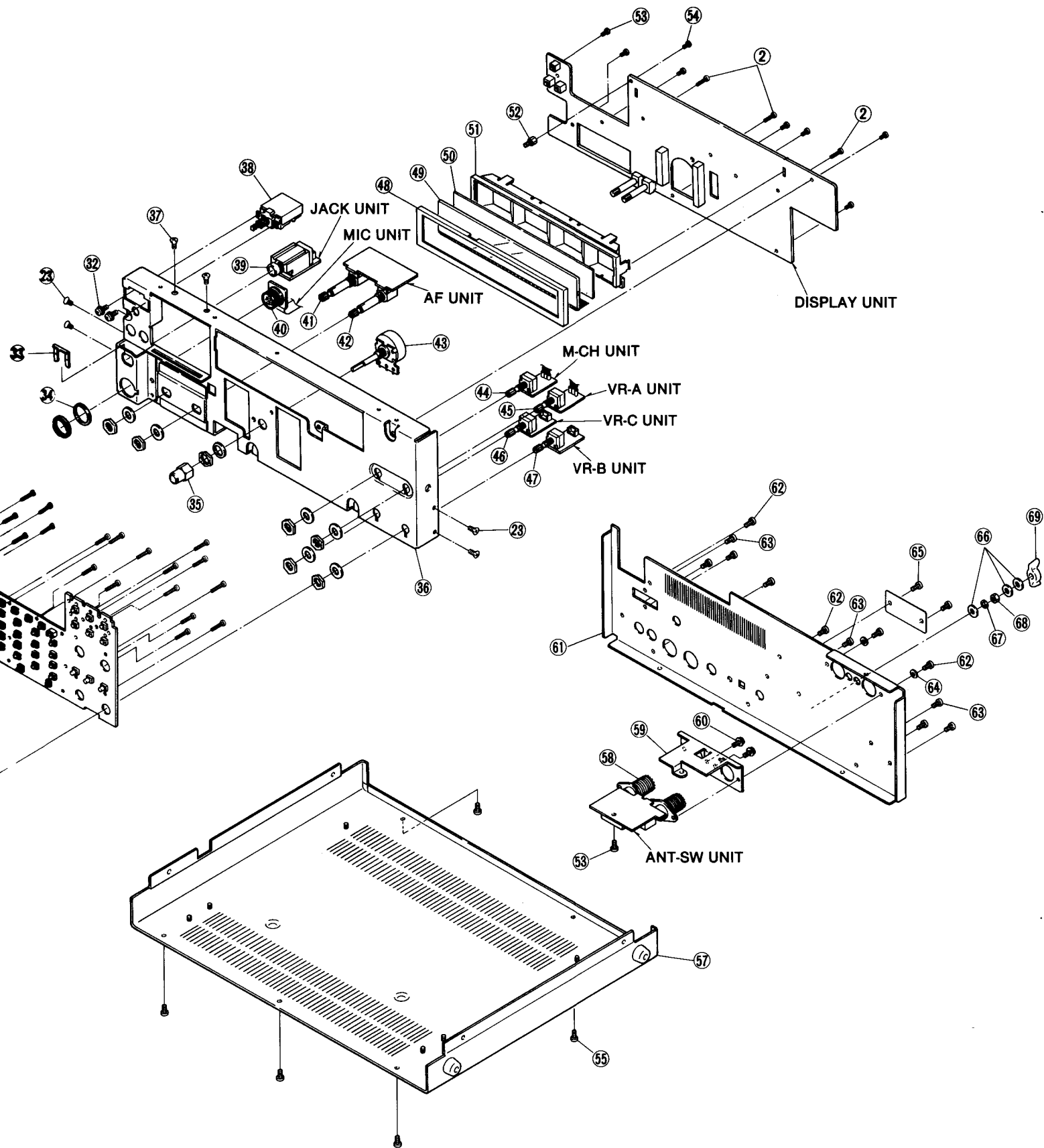

7-2 CHASSIS PARTS AND ACCESSORIES

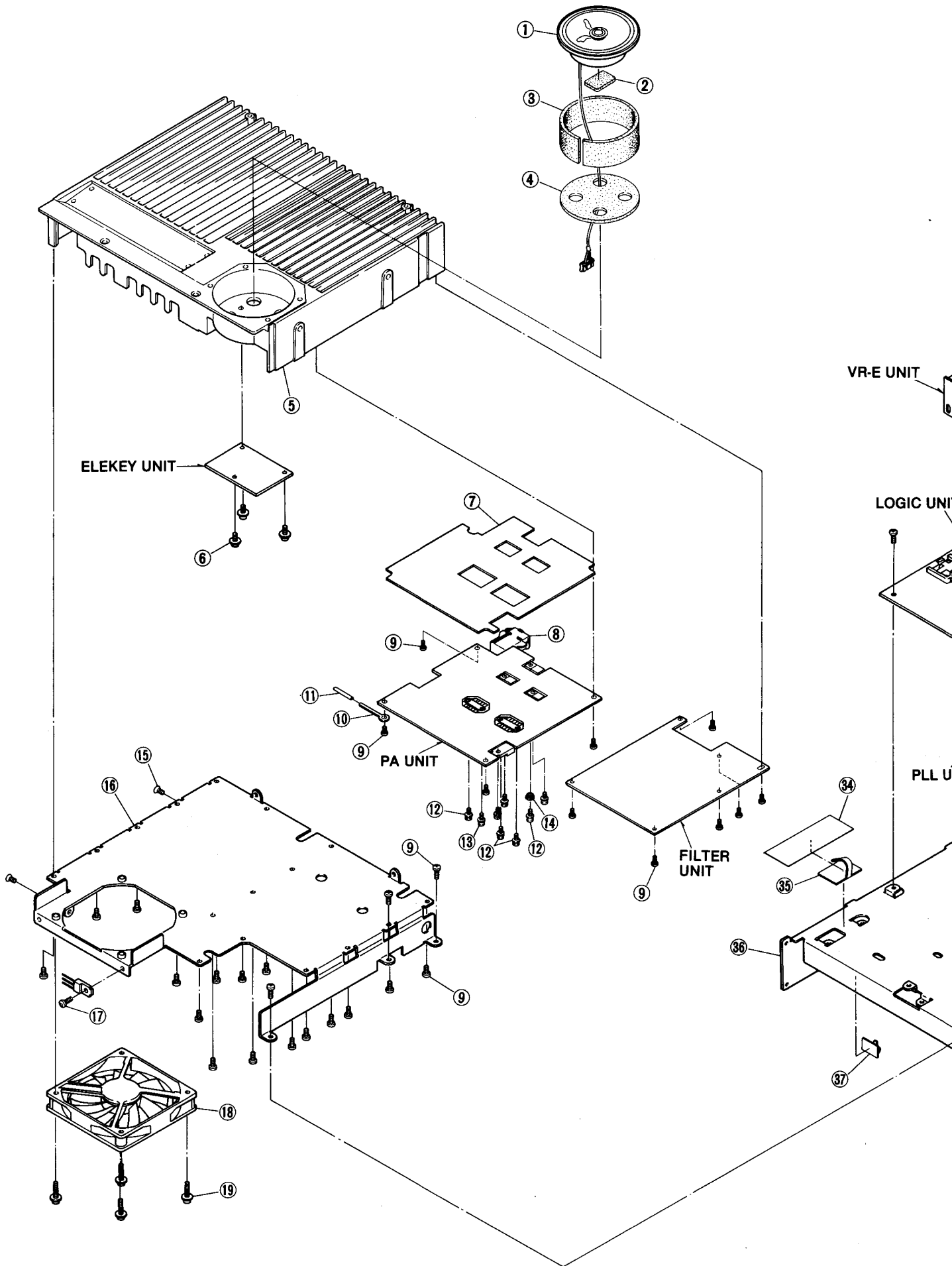

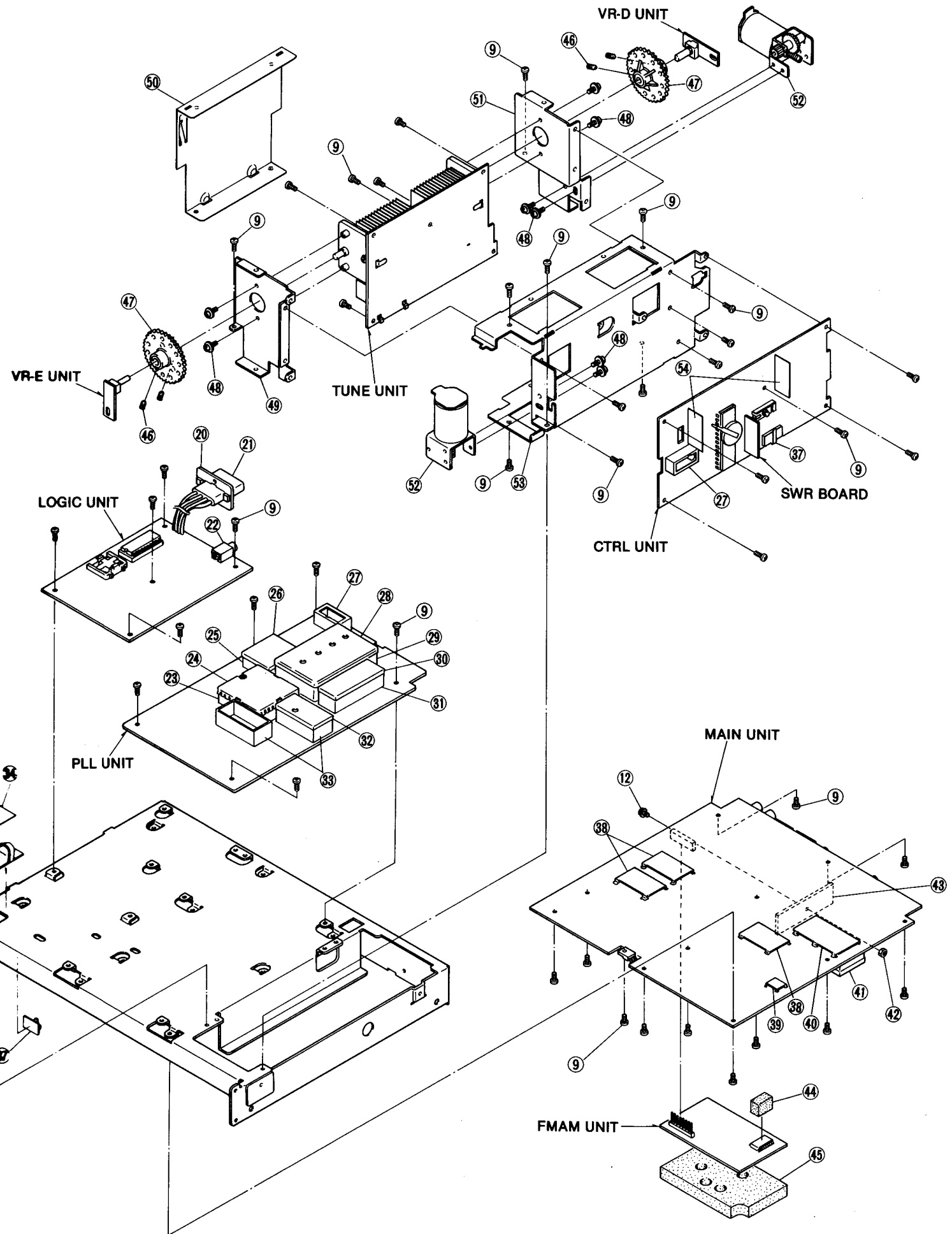

• CHASSIS PARTS

LABEL NUMBER	ORDER NO.	DESCRIPTION	QTY.	LABEL NUMBER	ORDER NO.	DESCRIPTION	QTY.
①	2510000040	Speaker C065K12I0810	1	②⑧	8510001340	79 shield case cover	1
②	8930006610	Sponge (AH)	1	②⑨	8510001330	79 shield case	1
③	8930007831	401 sponge (C) -1	1	③⑩	8510001740	Shield case cover	1
④	8930007821	401 sponge (B) -1	1	③①	8510001060	Shield case	1
⑤	8410000782	401 heatsink-2	1	③②	8510000241	220 shield case cover -1	1
⑥	8810003160	Setscrew A M3×6	3	③③	8510000230	220 shield case	2
⑦	8930007620	PA insulate plate	1	③④	8930005180	Aluminum sheet G	1
⑧	6510003780	Connector LLR-06 [DC13.8V]	1	③⑤	6910003450	Wire sticker S-50	1
⑨	8810001350	Screw PH B1 M3×6	72	③⑥	8010014200	1296 main chassis	1
⑩	6910000690	Clip 59TC4772	1	③⑦	8950002460	Wire sticker S-10 silver	2
⑪	9034003901	Tube D=2.0 L=30mm	1	③⑧	8510003160	VCO shield plate	3
⑫	8810003170	Setscrew A M3×8	8	③⑨	8510002280	VCO shield plate (A)	1
⑬	8810003210	Setscrew A M3×15	1	④⑩	8510004370	506 shield plate	1
⑭	6910000310	Insulate bush B312D	1	④①	8510001101	Shield case (A) cover (A) -1	1
⑮	8810002260	Screw FH B0 M3×6	2	④②	8830000100	Nut M3	1
⑯	8510007870	1296 PA cover	1	④③	8410000910	Heatsink	1
⑰	8810001360	Screw PH B1 M3×8	1	④④	8930014500	Sponge (BN)	1
⑱	2710000390	Fan FBA08T12L	1	④⑤	8930027130	1296 AM sponge	1
⑲	8810007740	Setscrew C M4×20	4	④⑥	8810003540	Screw enameled M4×6 ZK	4
⑳	8930026960	1296 connector plate	1	④⑦	8930005940	Gear G-16	2
㉑	6510001920	Connector 1490R [TUNER]	1	④⑧	8810003360	Setscrew C M3×6	8
㉒	6450000140	Connector HSJ0807-01-010 [REMOTE]	1	④⑨	8010014230	1296 B-chassis	1
㉓	8510005310	DDS shield case	1	⑤⑩	8110005000	1296 shield cover	1
㉔	8510005320	DDS shield case cover	1	⑤①	8010014240	1296 C-chassis	1
㉕	8510002690	PA shield case (B)	1	⑤②	8930000880	Motor HMK2601-01-030 (incl. gear)	2
㉖	8510004360	PA shield case (B) cover (A)	1	⑤③	8010014210	1296 A-chassis	1
㉗	8510002200	VCO case	2	⑤④	8510000500	PA shield plate B	2

Screw abbreviations PH: Pan head FH: Flat head B0, B1: Self-tapping ZK: Black

• ACCESSORIES

LABEL NUMBER	ORDER NO.	DESCRIPTION	QTY.
①	8900000220	DC power cable OPC-025 A	1
②	Optional product	HM-36 HAND MICROPHONE	1
③	5210000080	Spare fuse FGB 20A	1
④	5210000130	Spare fuse FGB 4A	1
⑤	5610000050	CW keyer plug AP330	1

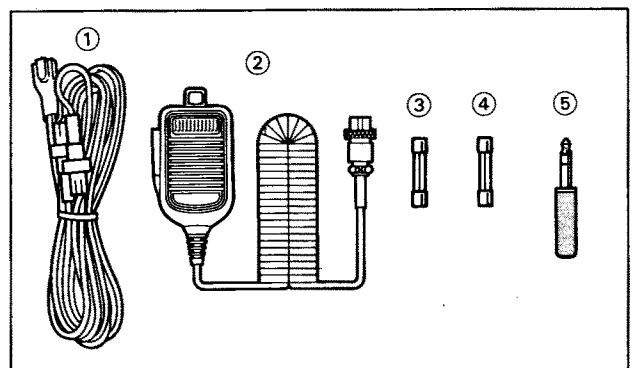

SECTION 8 BOARD LAYOUTS

8-1 MAIN UNIT

• NOTCH BOARD

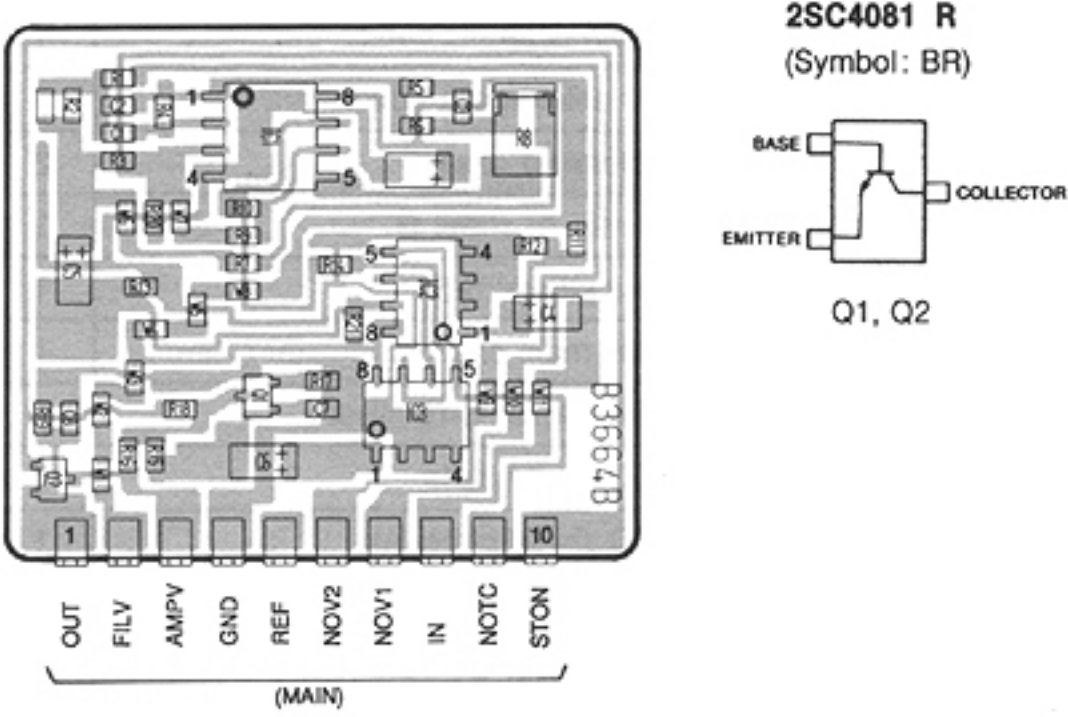

• FMAM UNIT

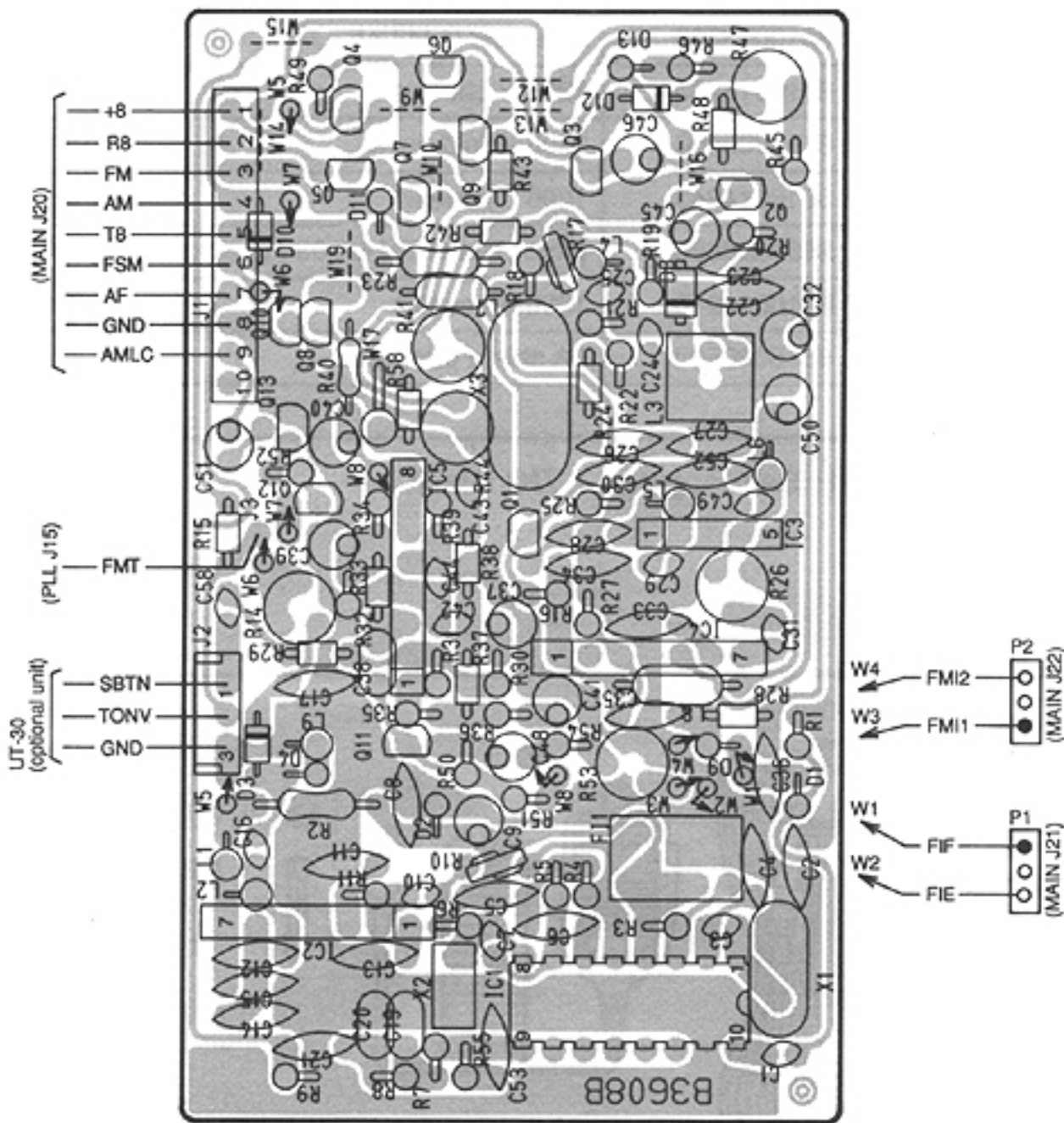

• MAIN UNIT

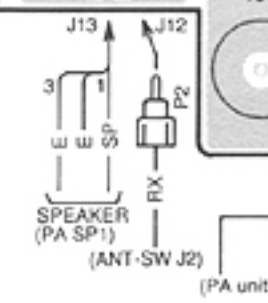
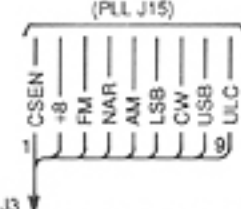
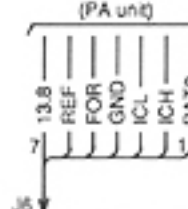
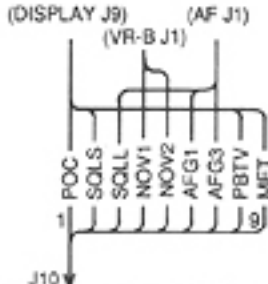
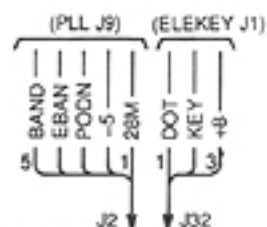
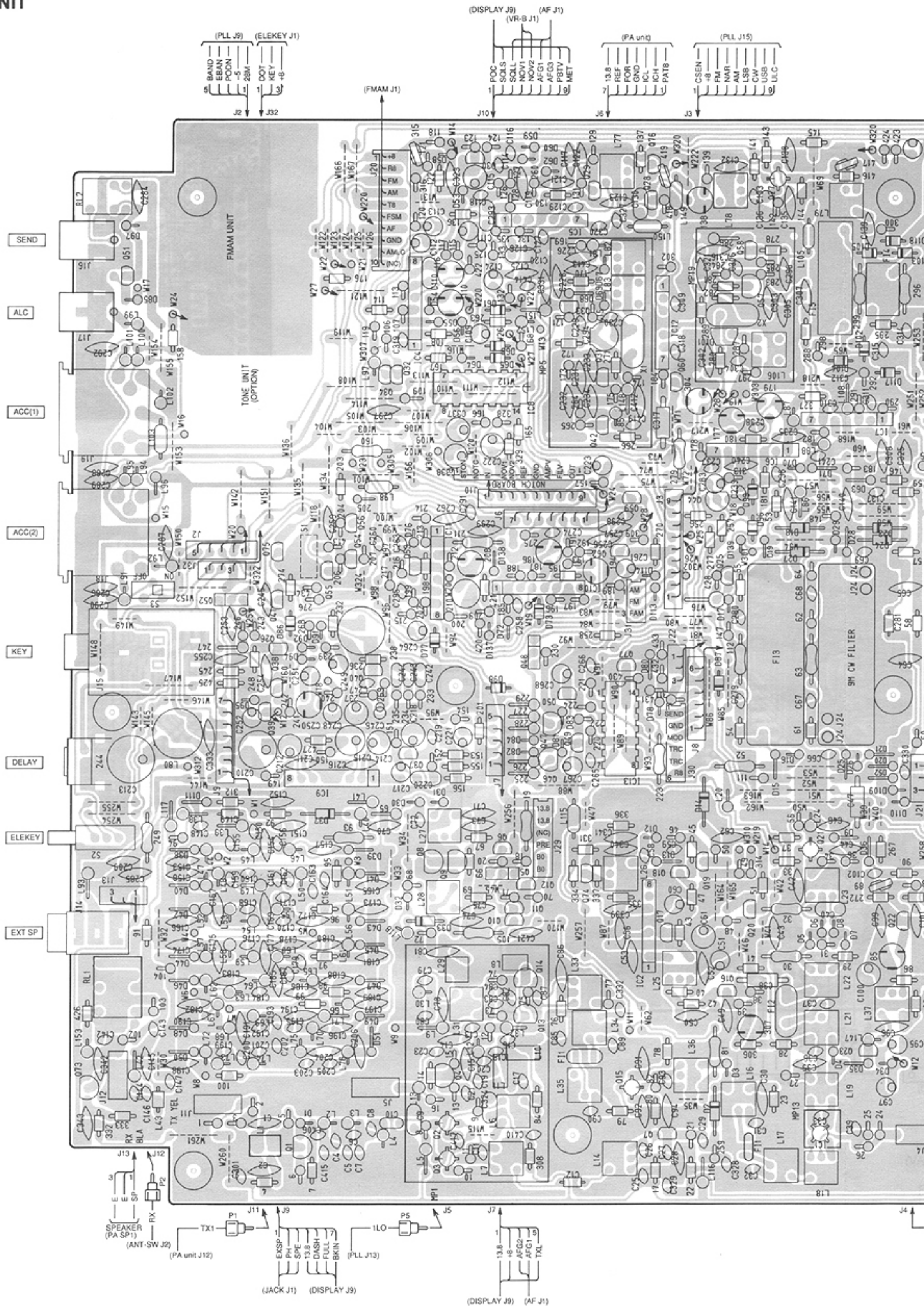

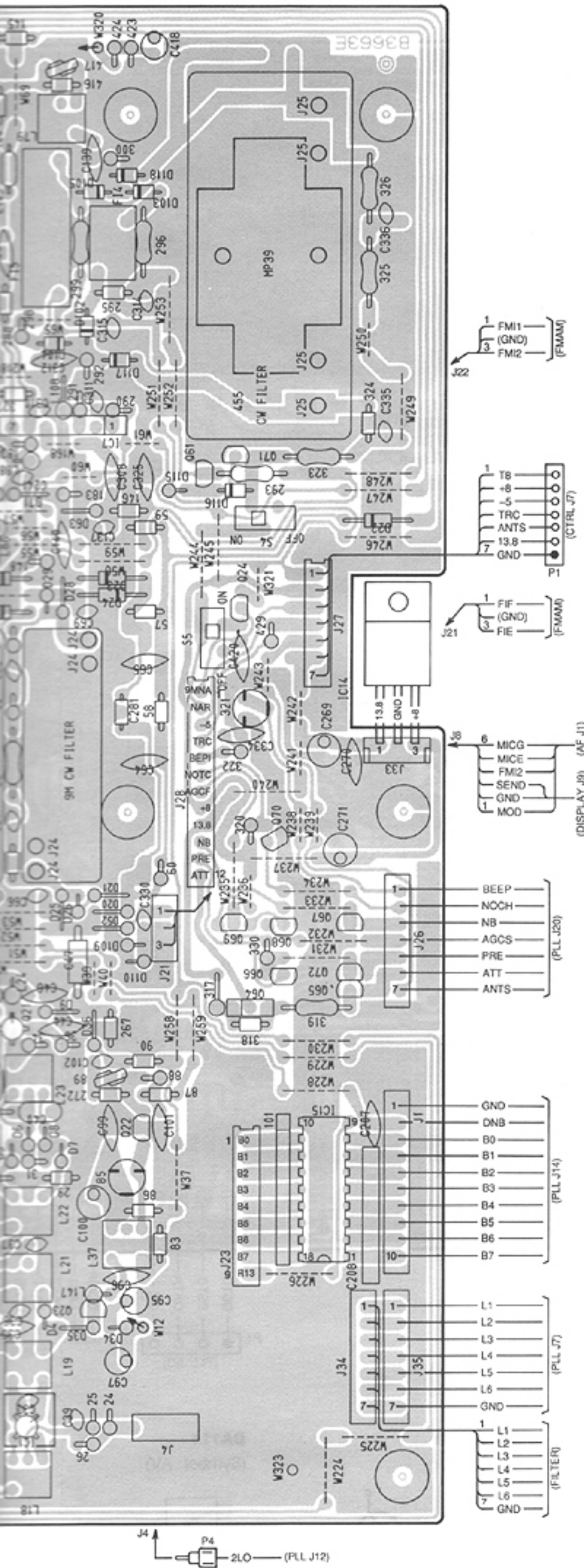

2SC2053

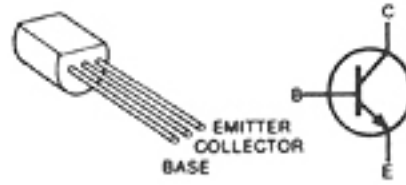

Q1, Q4

3SK122

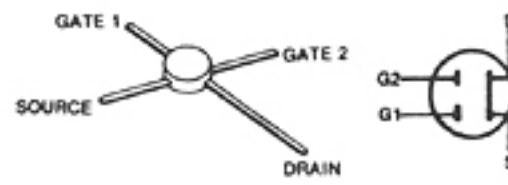

Q2, Q3

2SB909M



Q5, Q64

RN1202

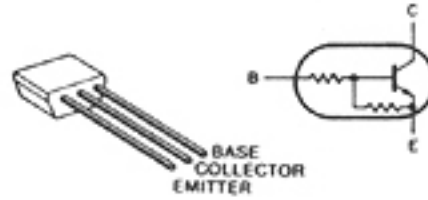

Q6, Q12, Q23, Q32,
Q34, Q51, Q61, Q65,
Q66, Q67, Q68, Q70,
Q71, Q72, Q75

2SK241

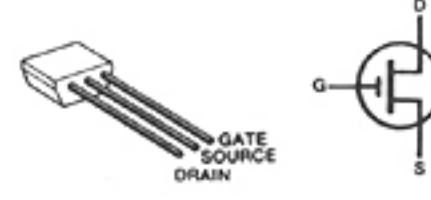

Q7, Q22, Q28

2SK937

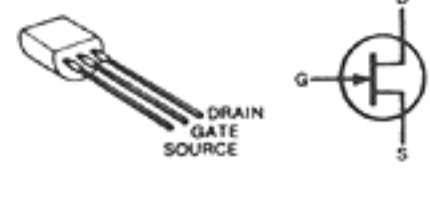

Q8, Q9, Q13, Q14

RN2202

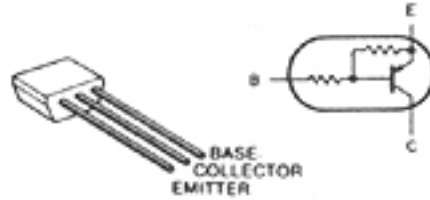

Q10, Q20, Q24, Q25,
Q41, Q69

2SC2458

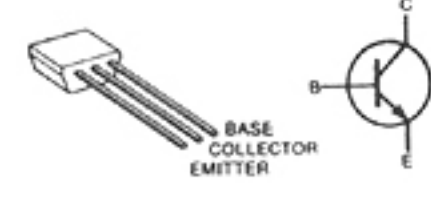

Q11, Q18, Q19, Q26,
Q29, Q30, Q31, Q37,
Q40, Q42, Q49, Q50,
Q56, Q58, Q74, Q76,
Q77

3SK101

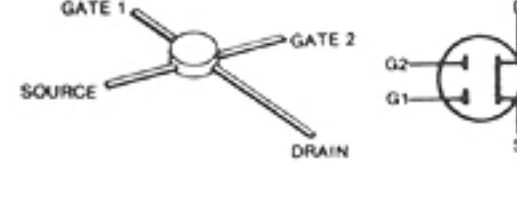

Q15, Q21, Q27

2SK192A

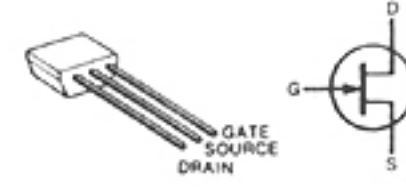

Q16

2SA1048

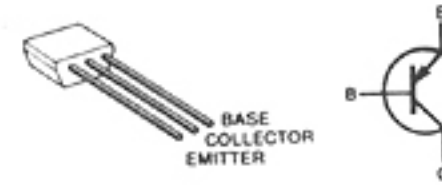

Q17, Q38, Q53

RN1204

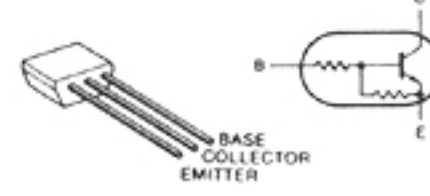

Q33, Q39, Q54, Q55,
Q60, Q62

2SC2878

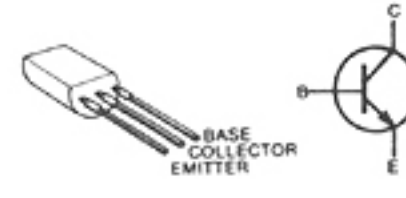

Q44, Q73

2SD468

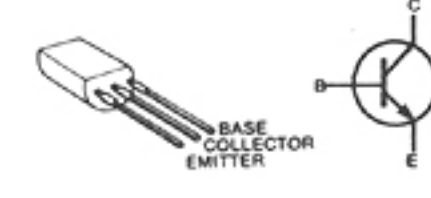

Q46, Q47

2SD1225M

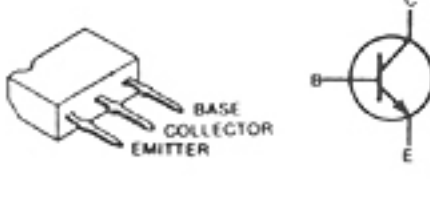

Q48, Q52

2SC1815

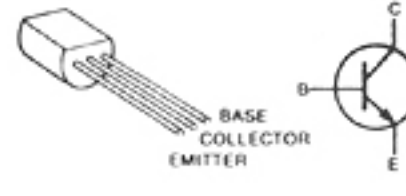

Q57

2SJ105

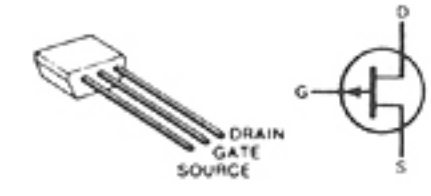

Q59

1SV101

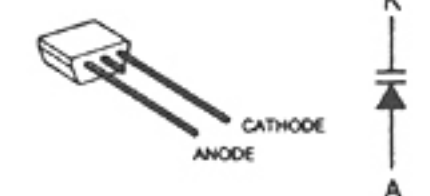

D101

8-2 LOGIC UNIT

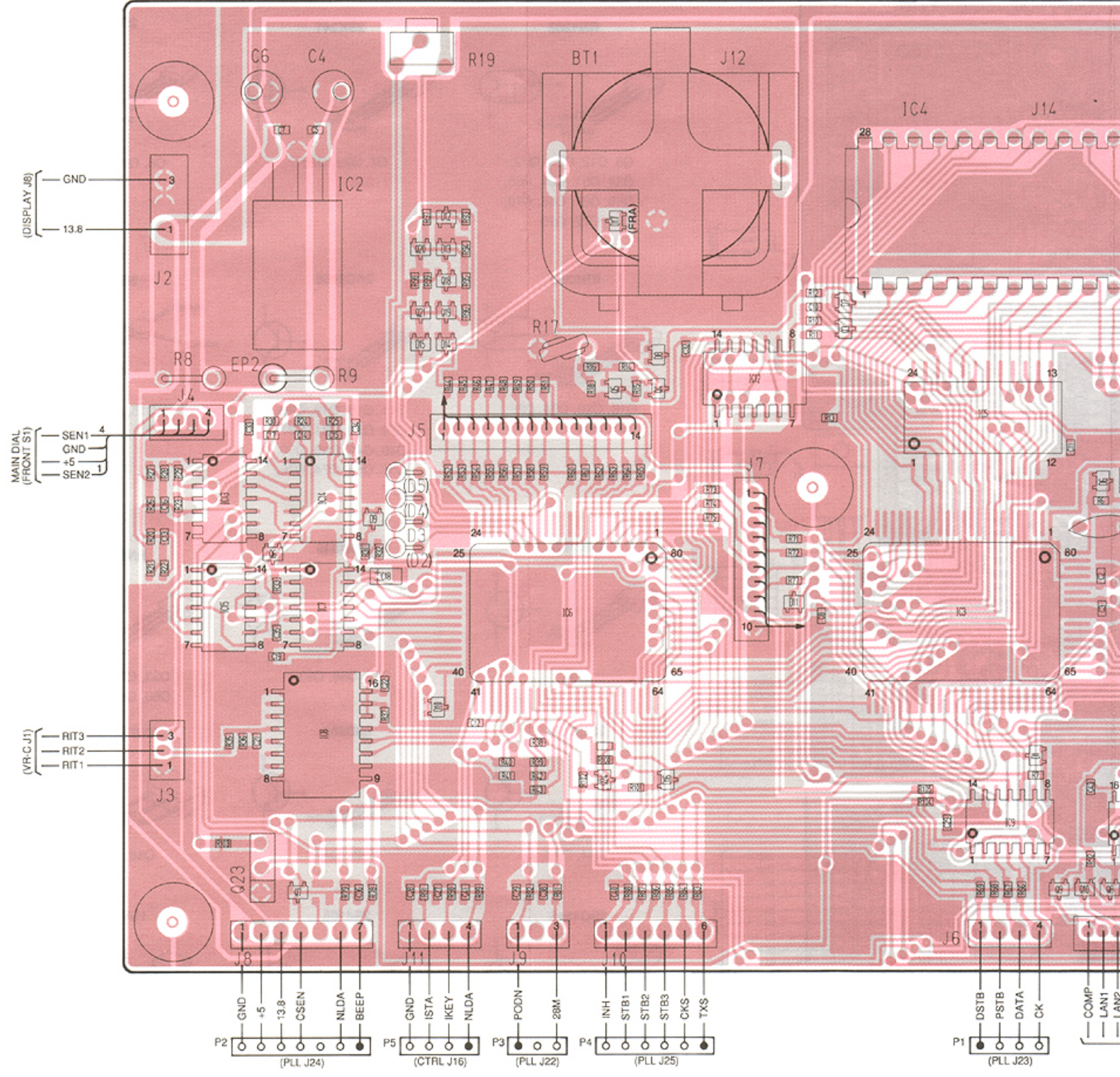
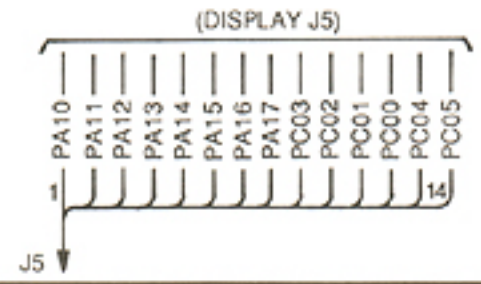

2SC4081 R
(Symbol: BR)

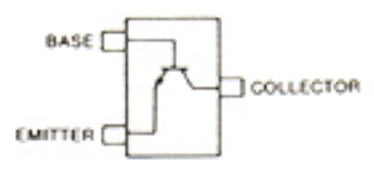

- Q1, Q2, Q3, Q5, Q18, Q24

2SA1576 R
(Symbol: FR)

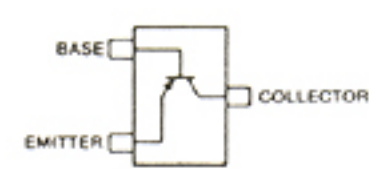

- Q4, Q19, Q20, Q21

DTC114EU
(Symbol: 24)

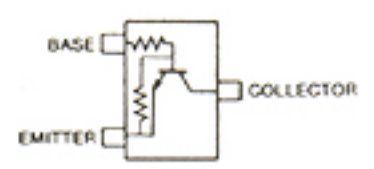

- Q6, Q7, Q8, Q9, Q10, Q11, Q12, Q13, Q14, Q15, Q16, Q17, Q22

2SD1225M

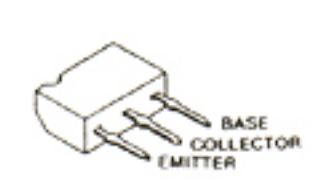

- Q23

DA114
(Symbol: AV)

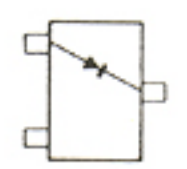

- D1, D6, D7, D8, D9, D10, D11, D12, D13, D14, D15, D16, D17 (FRA)

8-3 PLL UNIT

• DDS BOARD

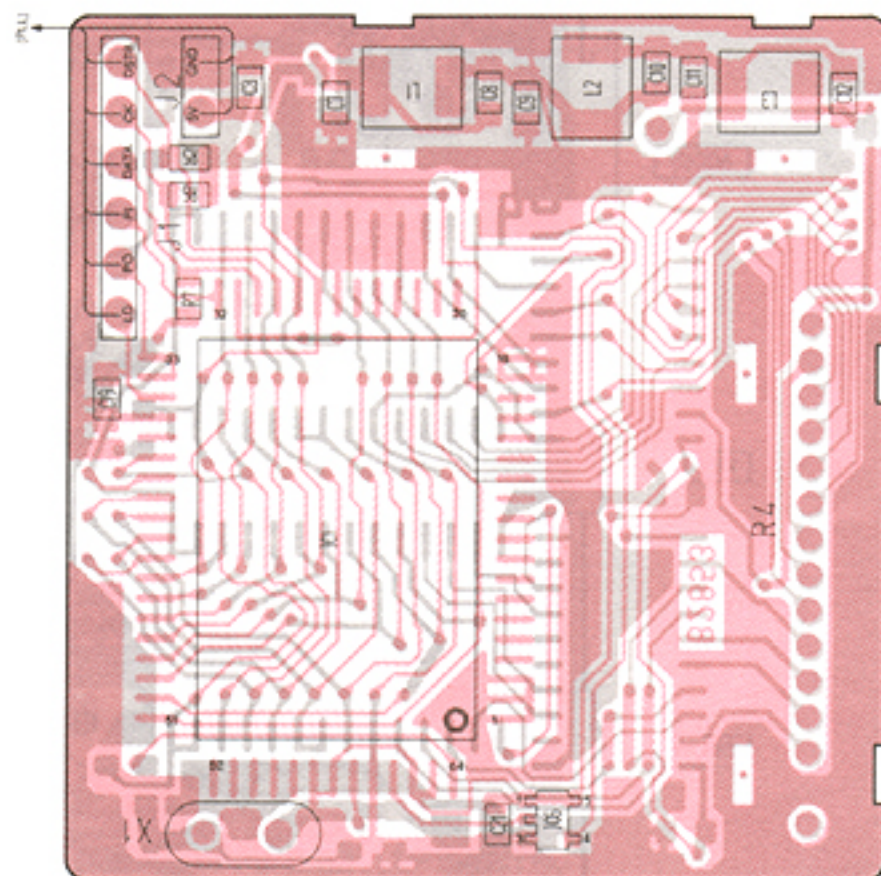
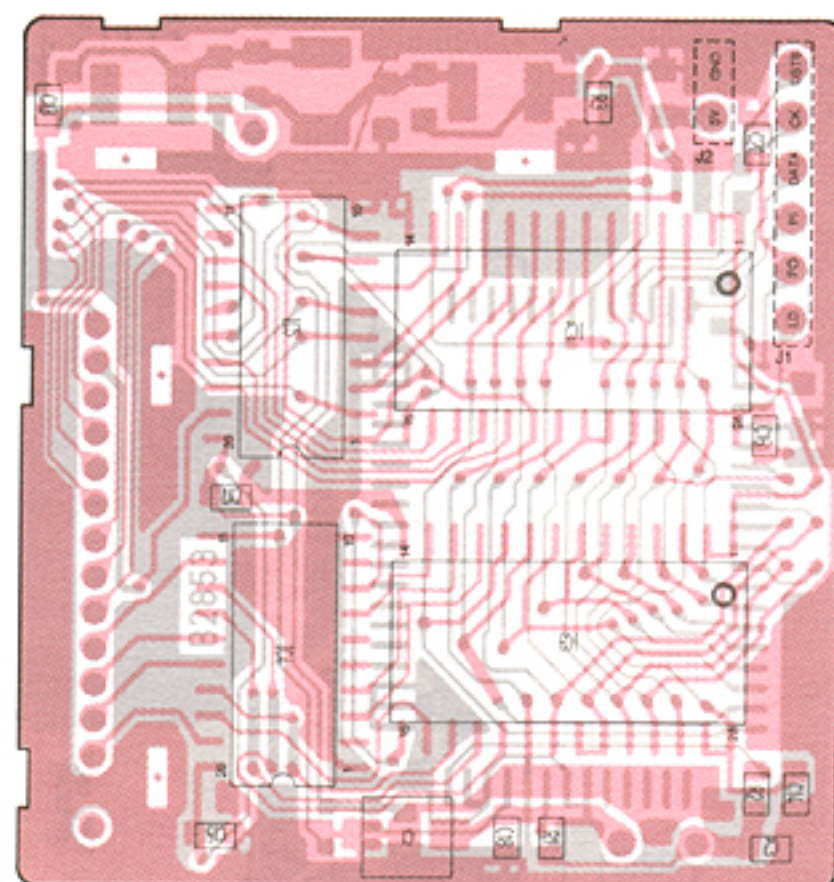
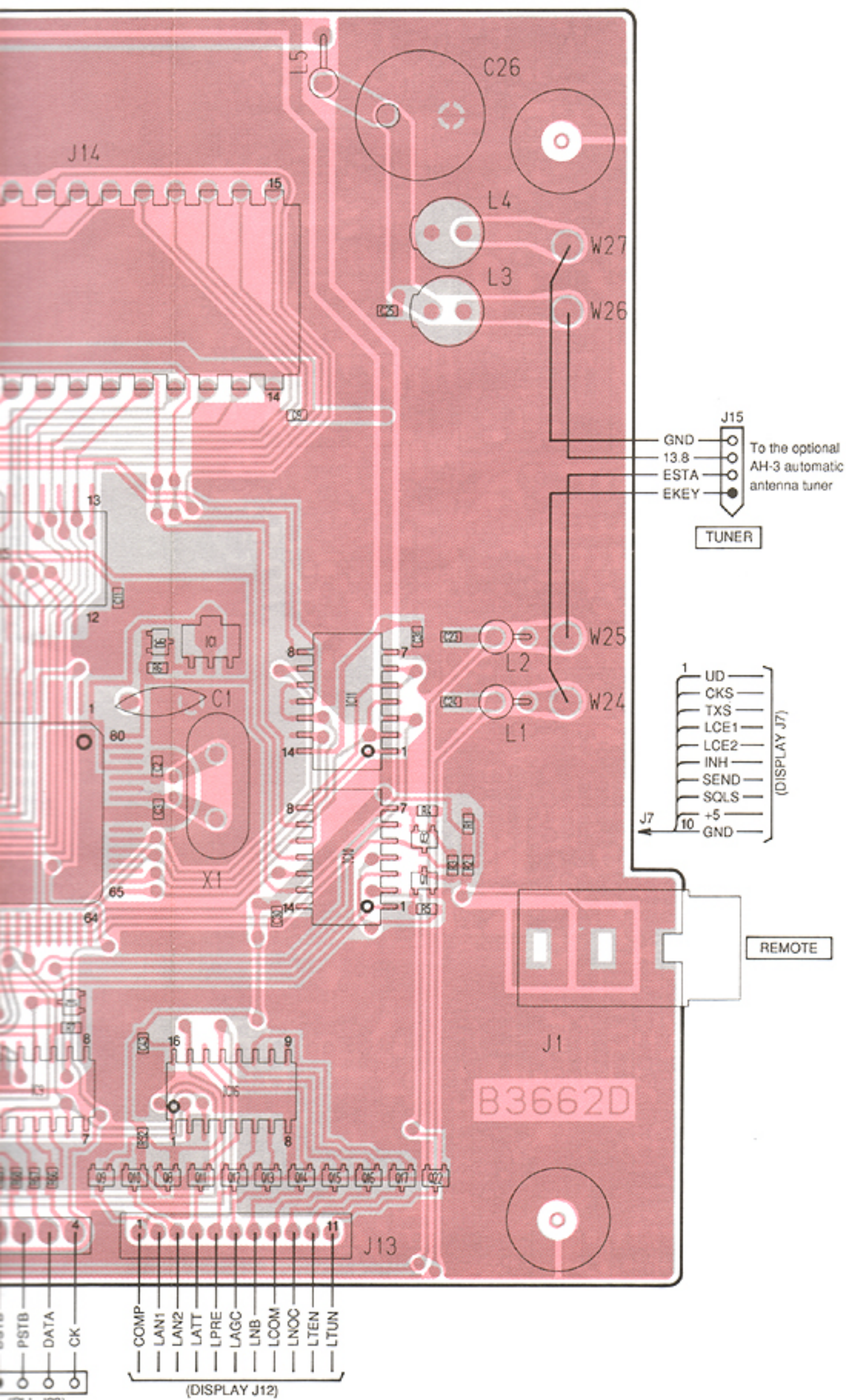

114
 Symbol: AV



D7, D8, D9,
 1, D12, D13,
 5, D16, D17 (FRA)

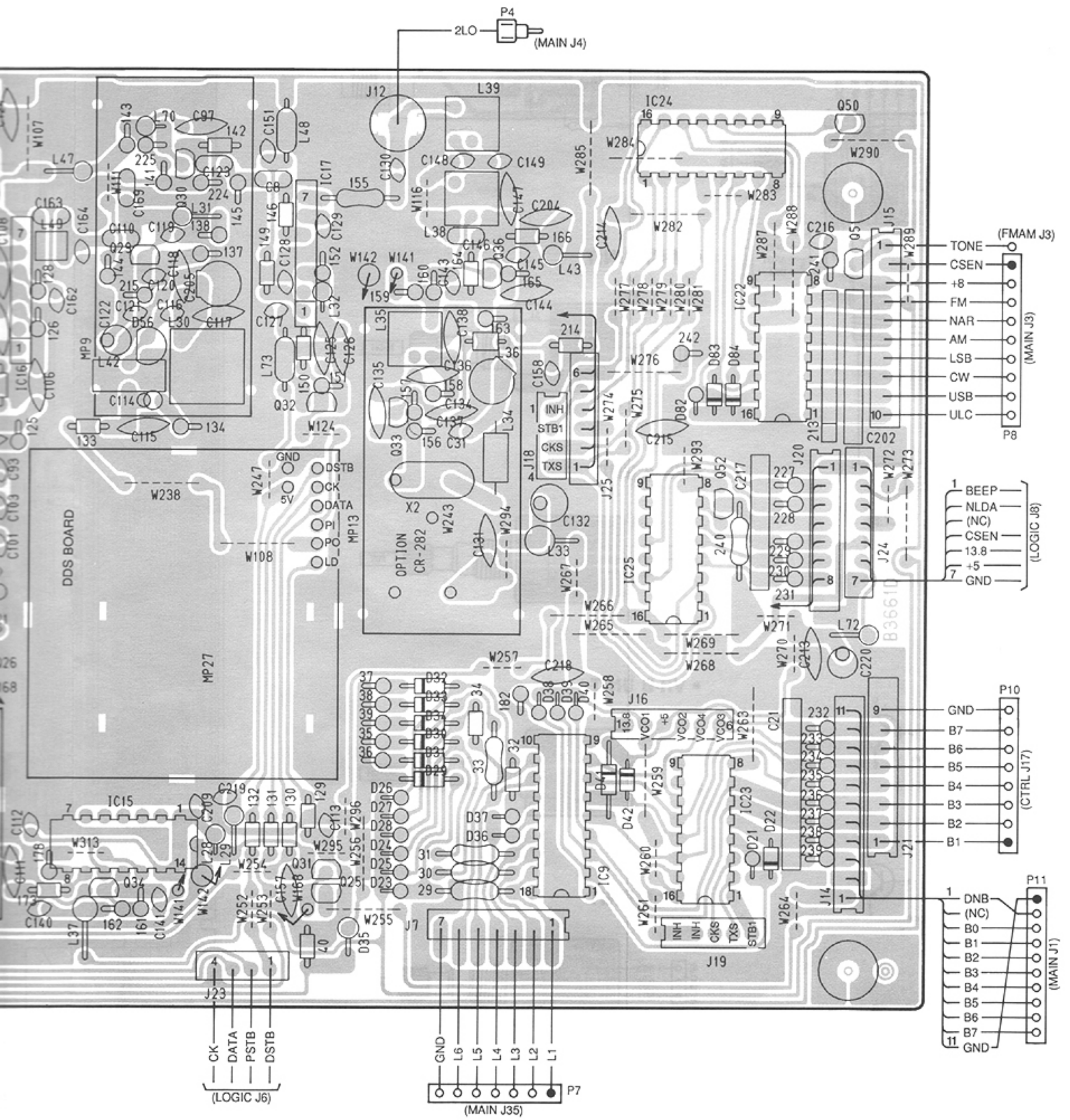

RN1202

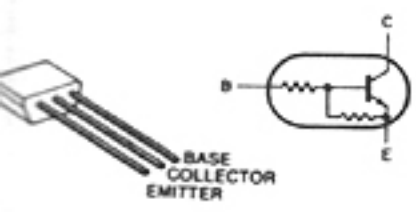

Q25, Q50, Q52, Q53

RN2202

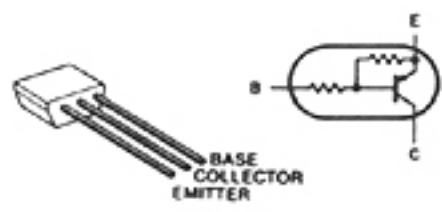

Q31, Q51, Q54

1SV101

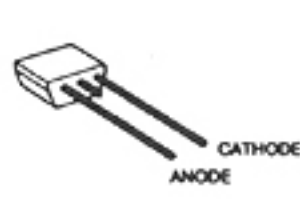

D48, D50, D52, D54

FC52M

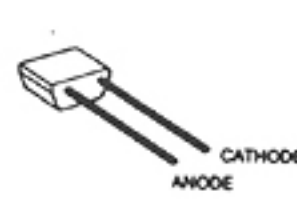

D56

8-4 SW AND DISPLAY UNITS

• AF UNIT

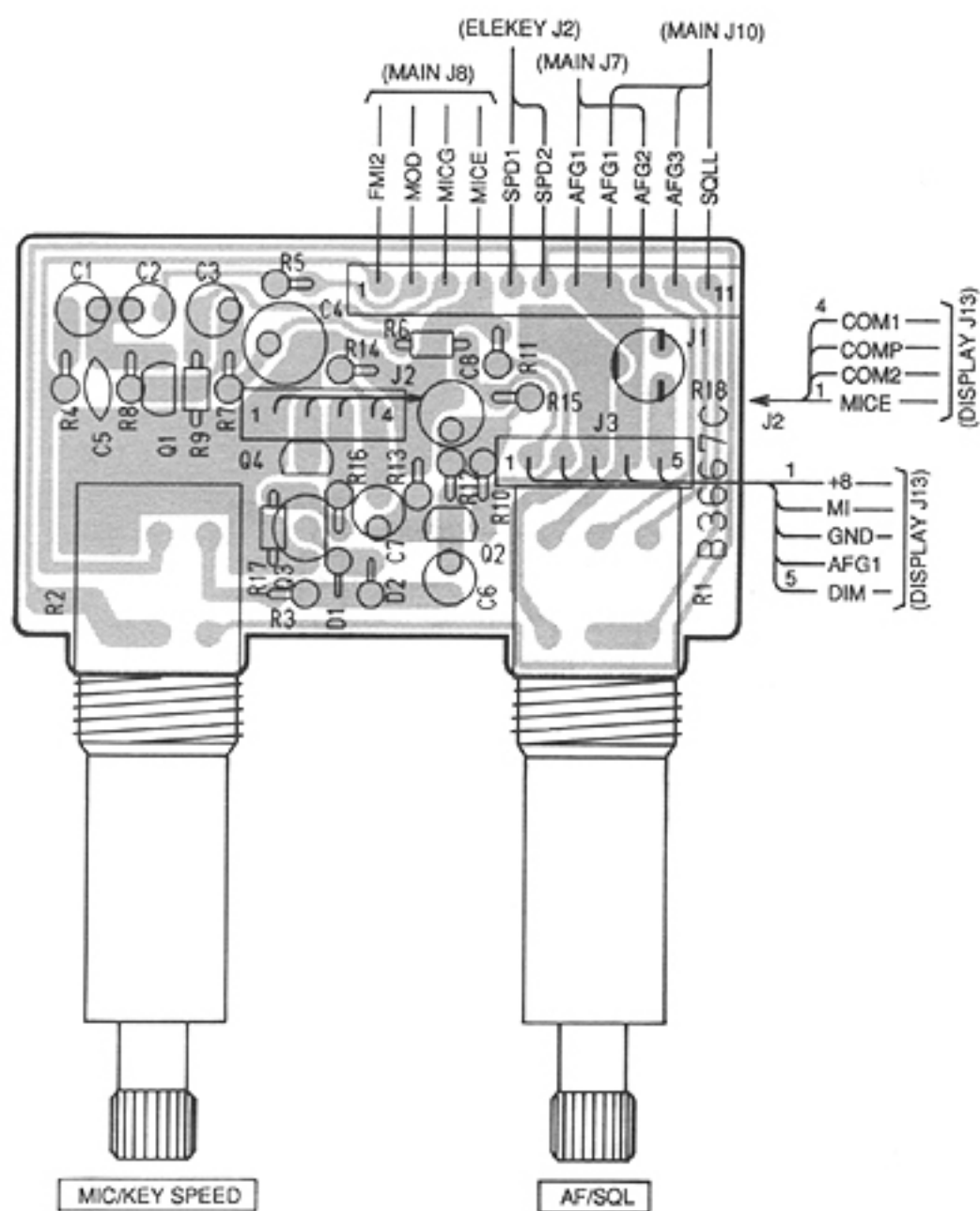

• JACK UNIT

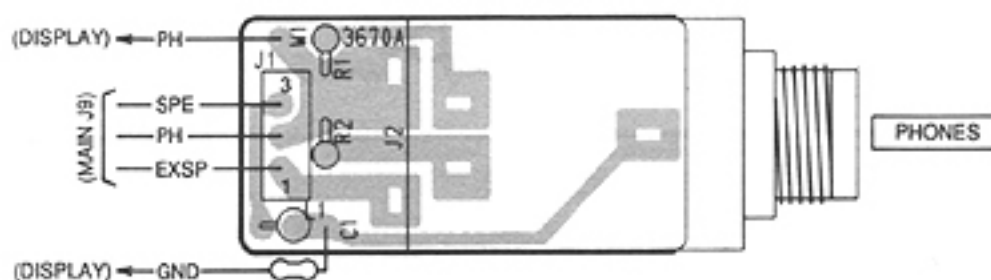

• M-CH UNIT

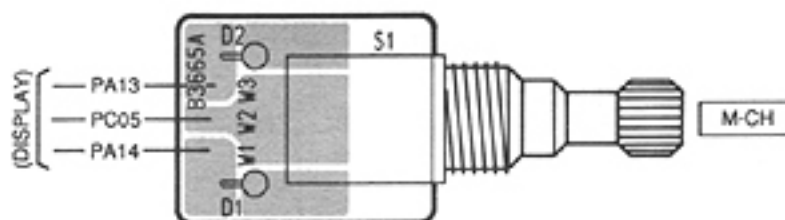

• VR-A UNIT

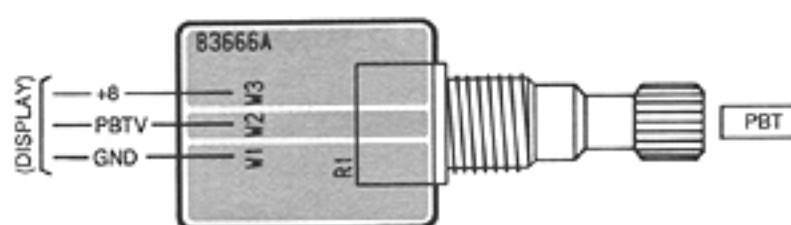

• VR-B UNIT

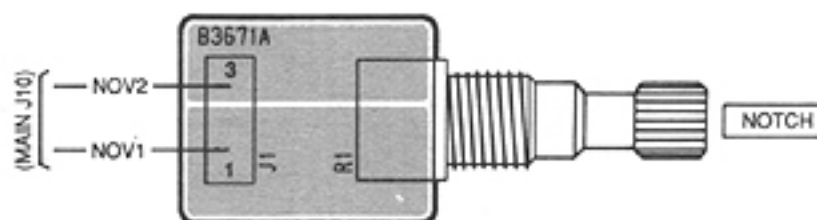

• VR-C UNIT

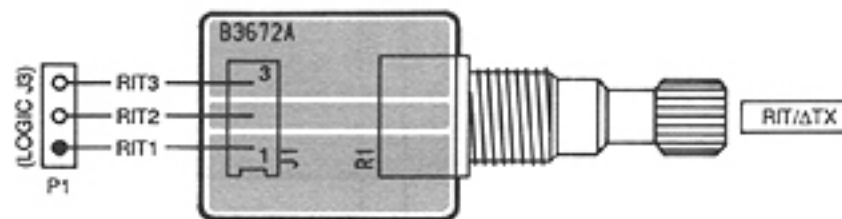

• MIC AMP BOARD

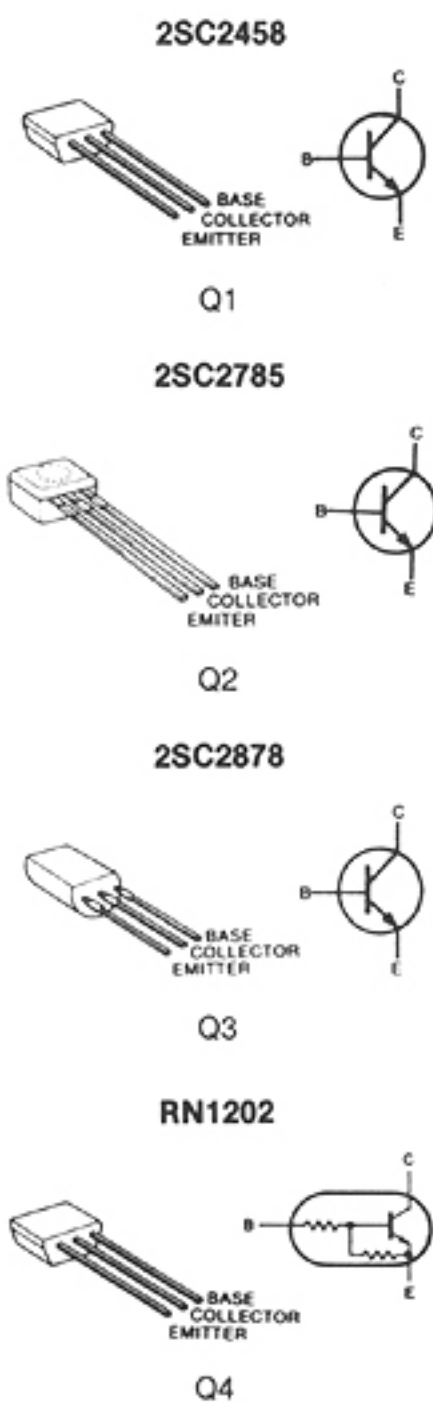

2SC3224 BL (Symbol: CBL)

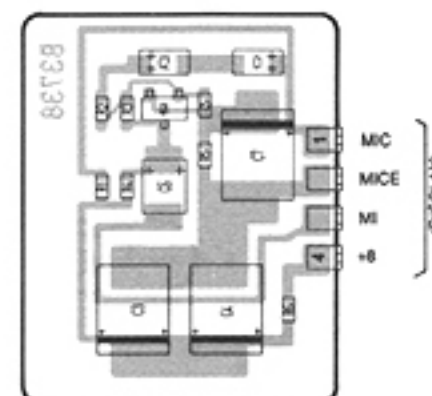
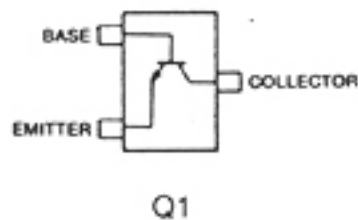

• DISPLAY UNIT

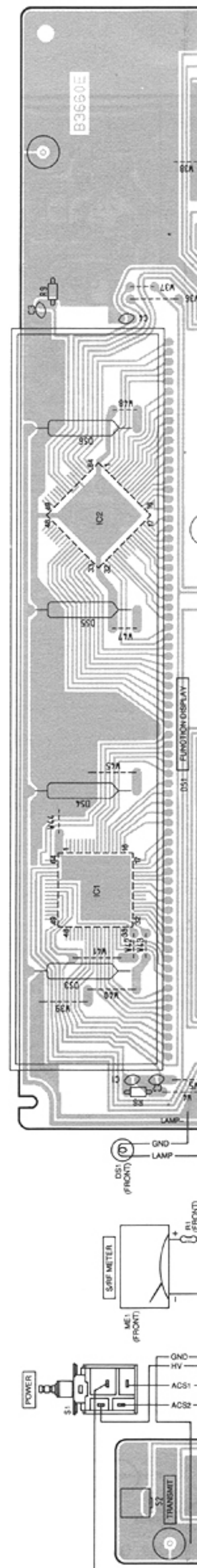

AY UNIT

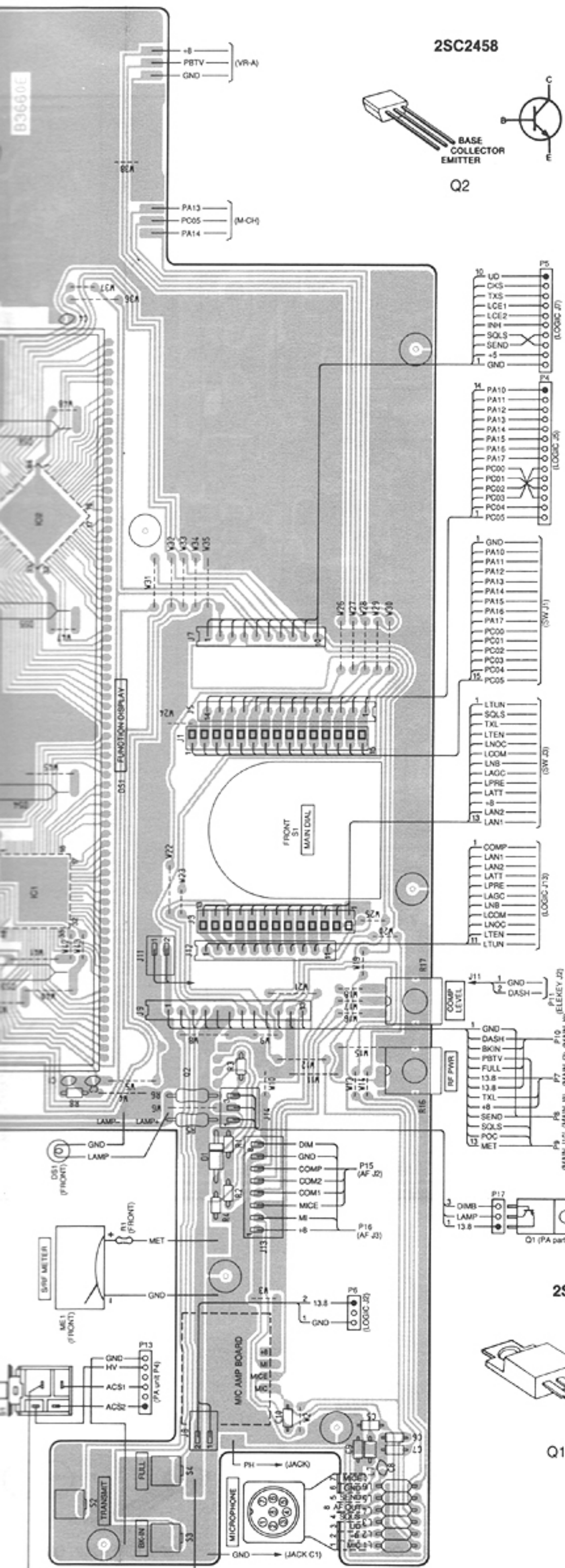

• SW UNIT

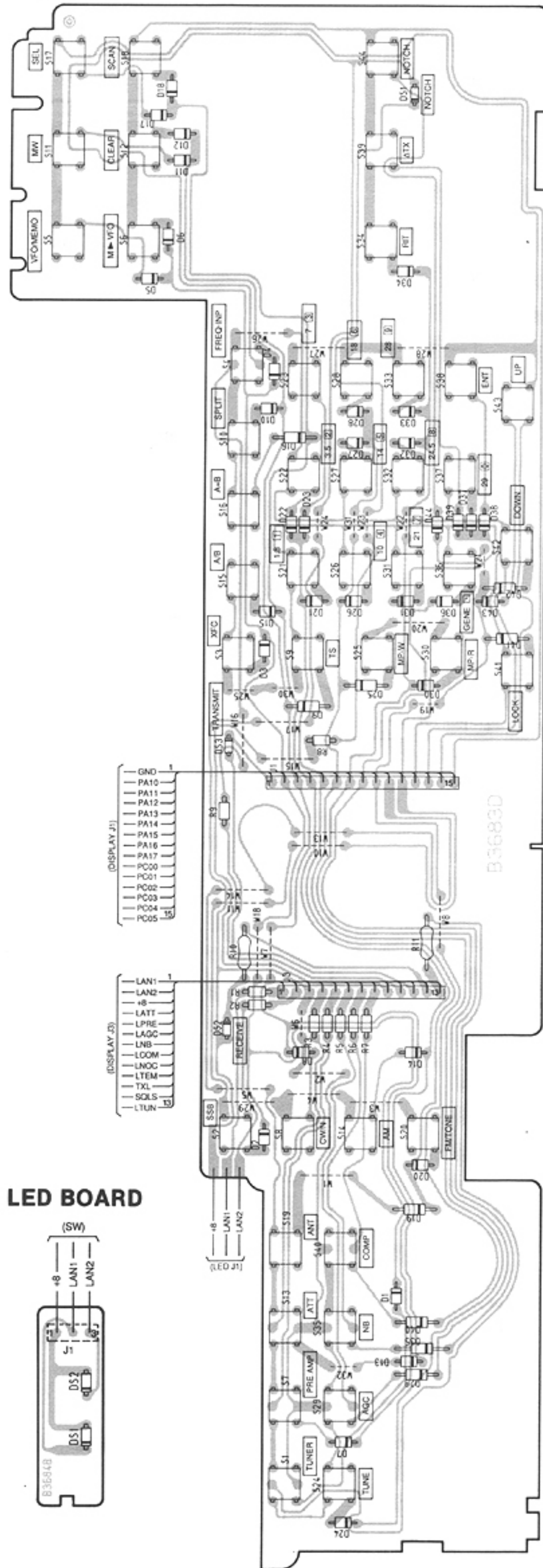

• LED BOARD

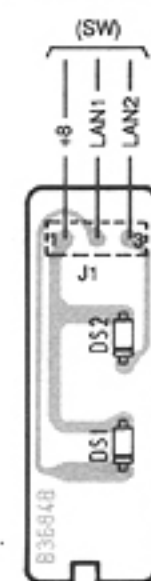

8-5 CTRL UNIT

• CTRL UNIT

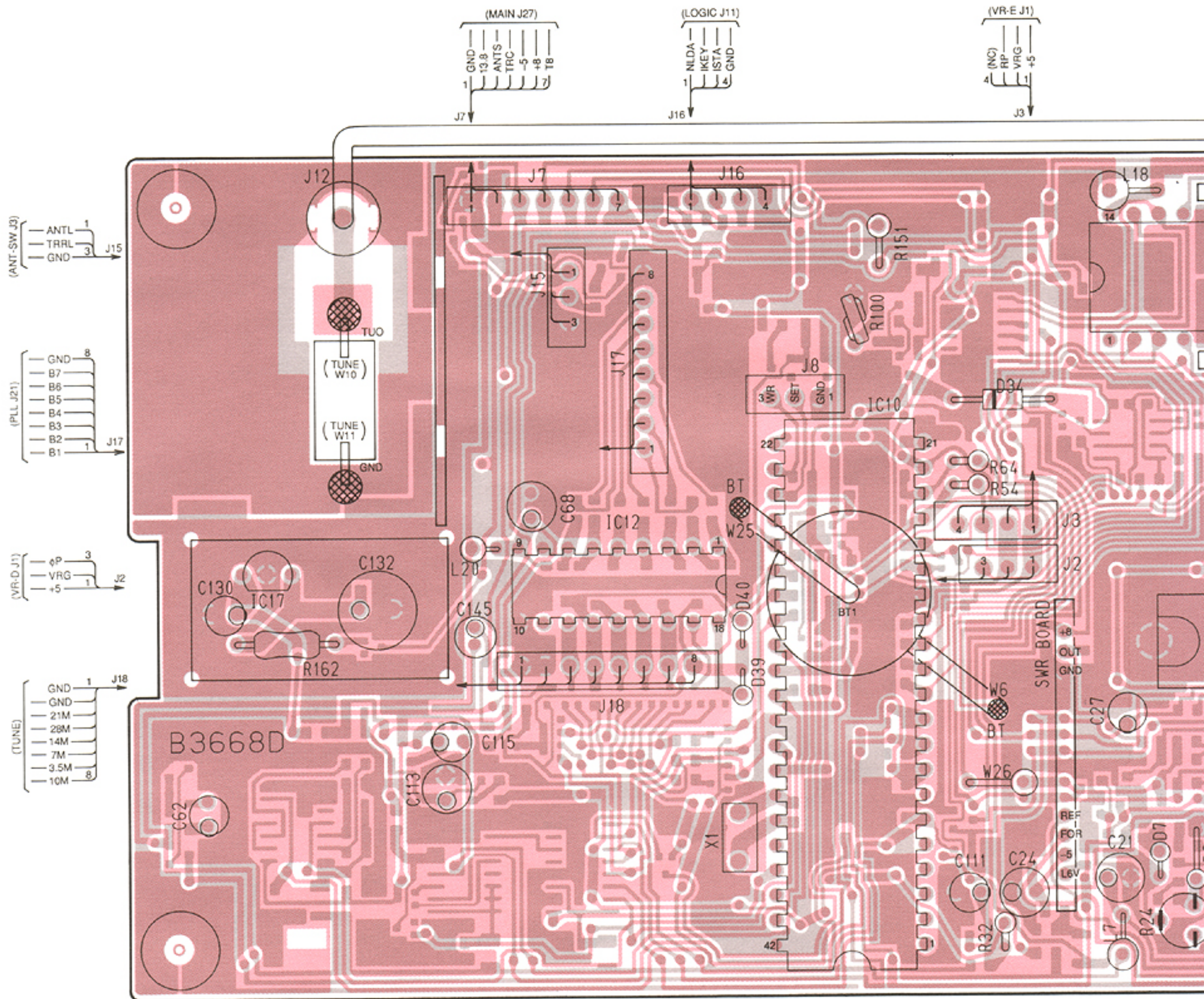

• SWR BOARD

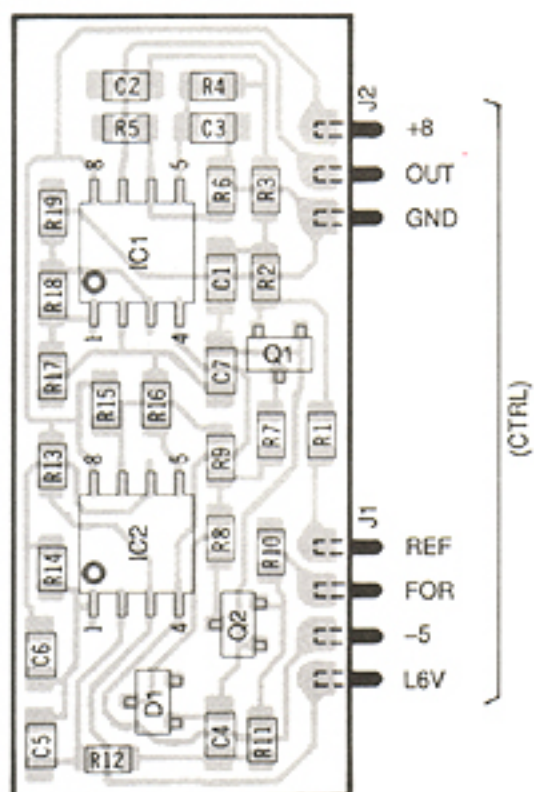

2SK209 Y (Symbol: XY)

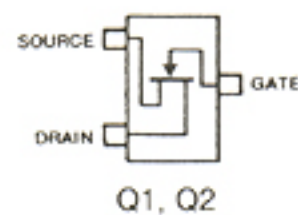

1SS187 (Symbol: D3)

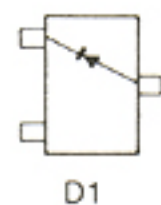

• ANT-SW UNIT

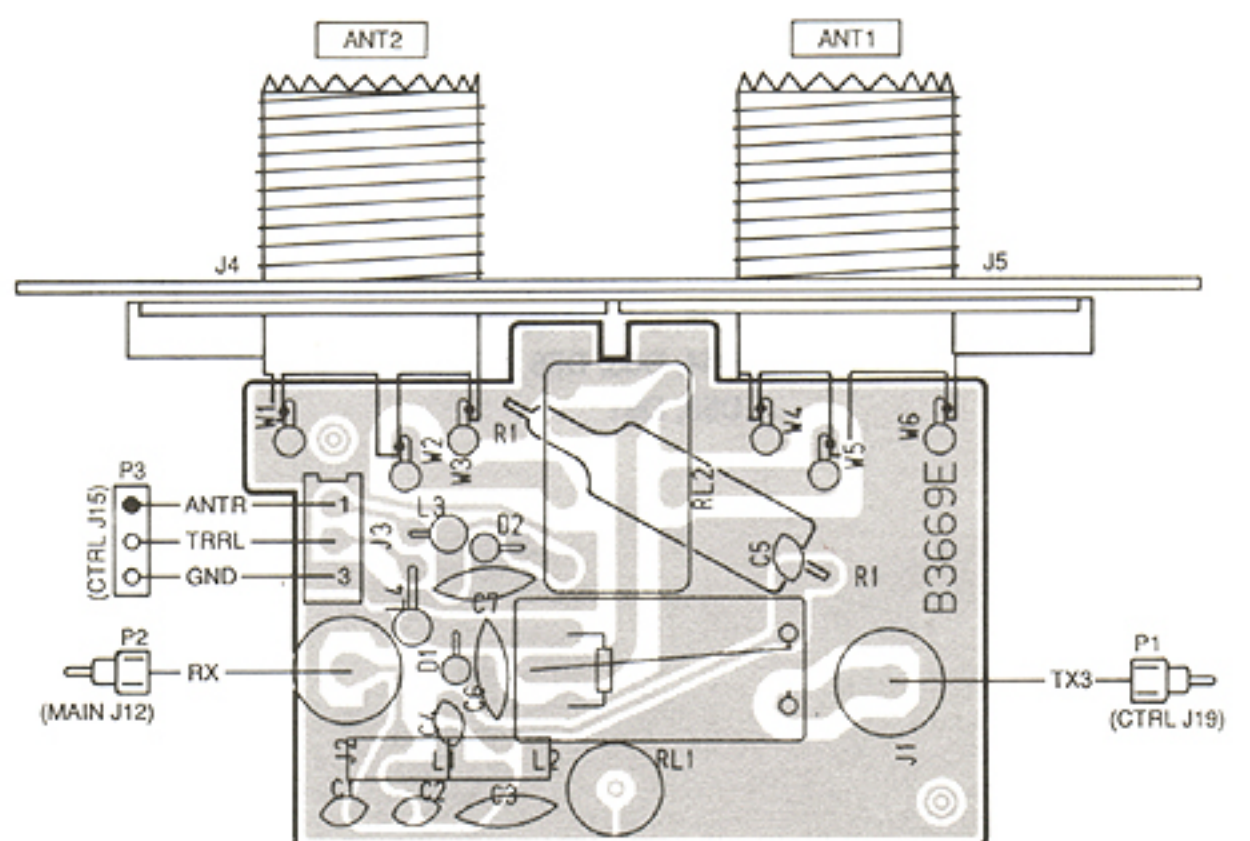

The combination of this page and the next page show the unit layout in the same configuration as the actual P.C. Board.

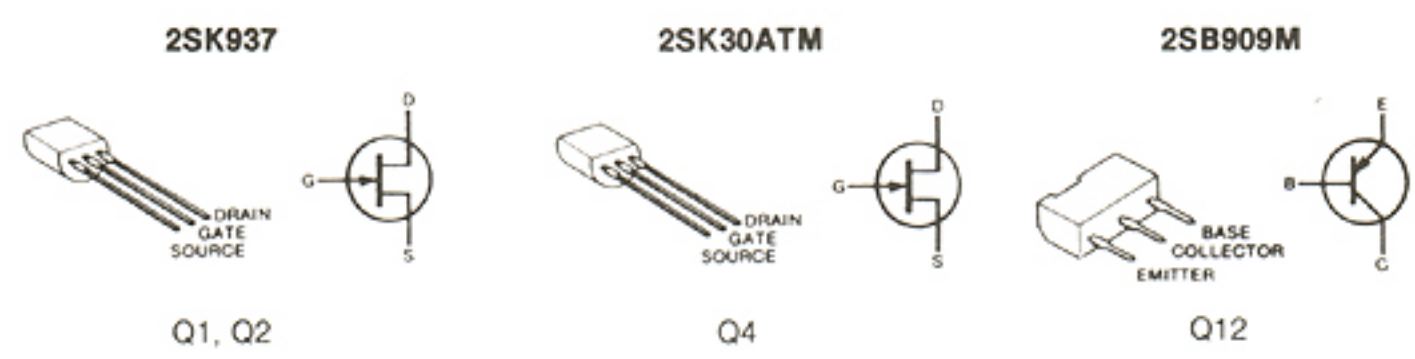
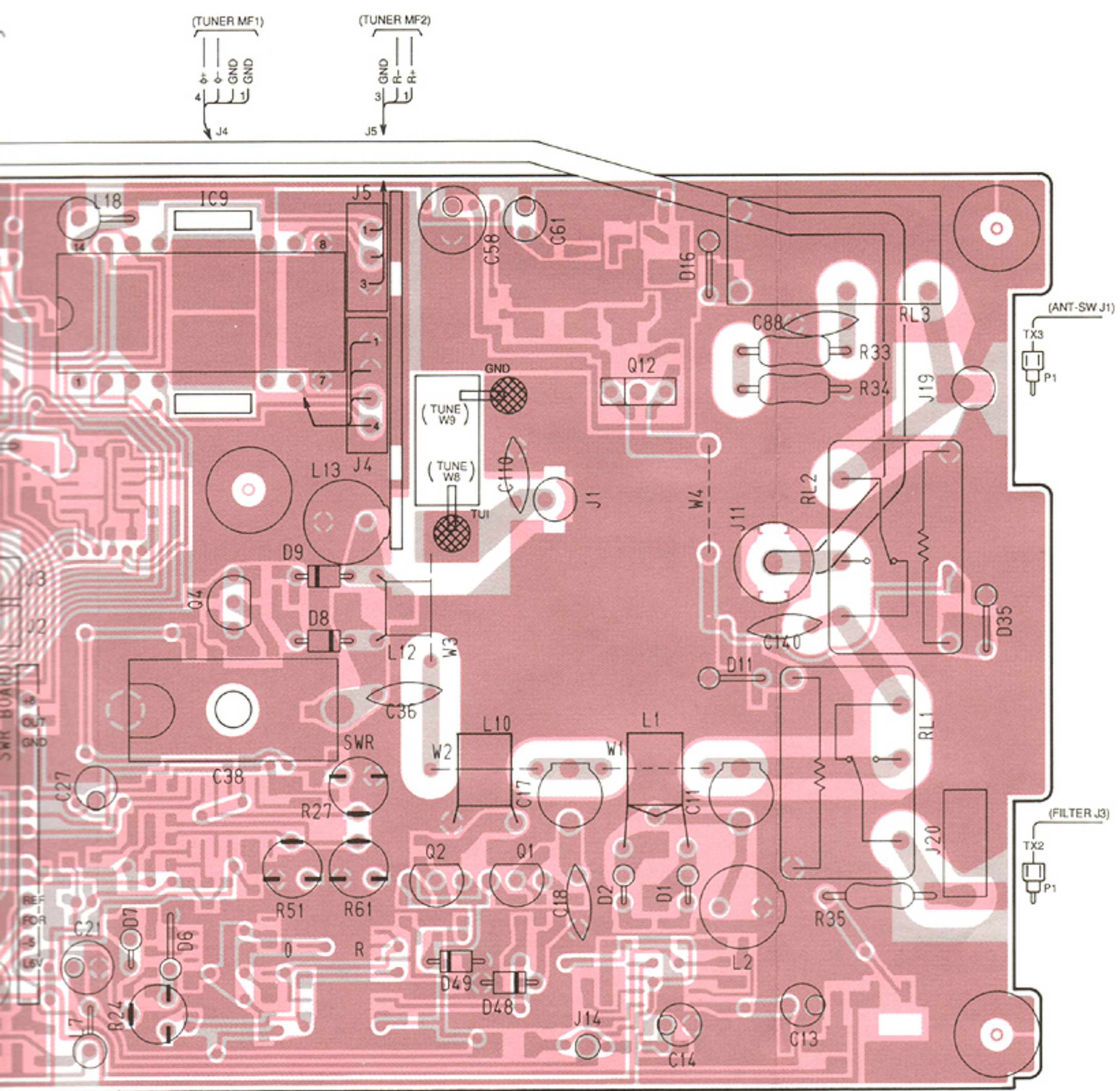

• CTRL UNIT

RN1402

(Symbol: XB)

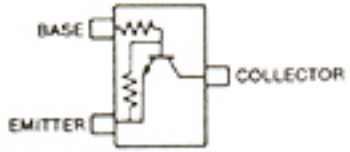

Q3, Q5, Q8, Q10, Q11,
Q34, Q35, Q43, Q45

RN2402

(Symbol: YB)

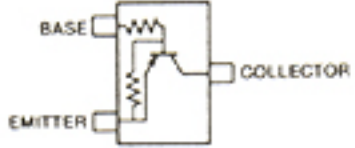

Q7, Q9, Q40, Q42, Q44

2SC2712 GR

(Symbol: LG)

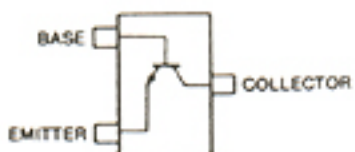

Q13, Q23

2SA1162 GR

(Symbol: SG)

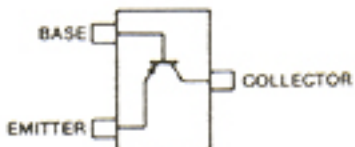

Q19, Q22

2SC3770 3

(Symbol: JY3)

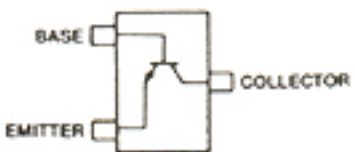

Q25, Q26

2SC3326 B

(Symbol: CCB)

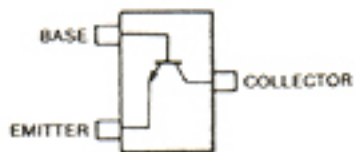

Q39

RN2404

(Symbol: YD)

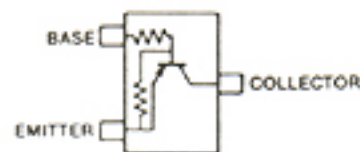

Q41

RN1404

(Symbol: XD)

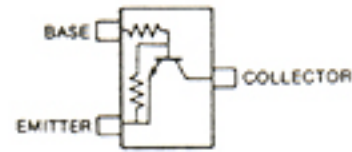

Q46

DA113W

(Symbol: AY)

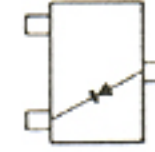

D10, D12, D13, D19,
D22, D27, D30, D45,
D47, D51

DAN202U

(Symbol: N)

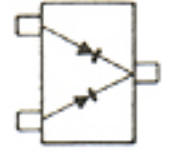

D14, D44, D52, D53,
D59, D60

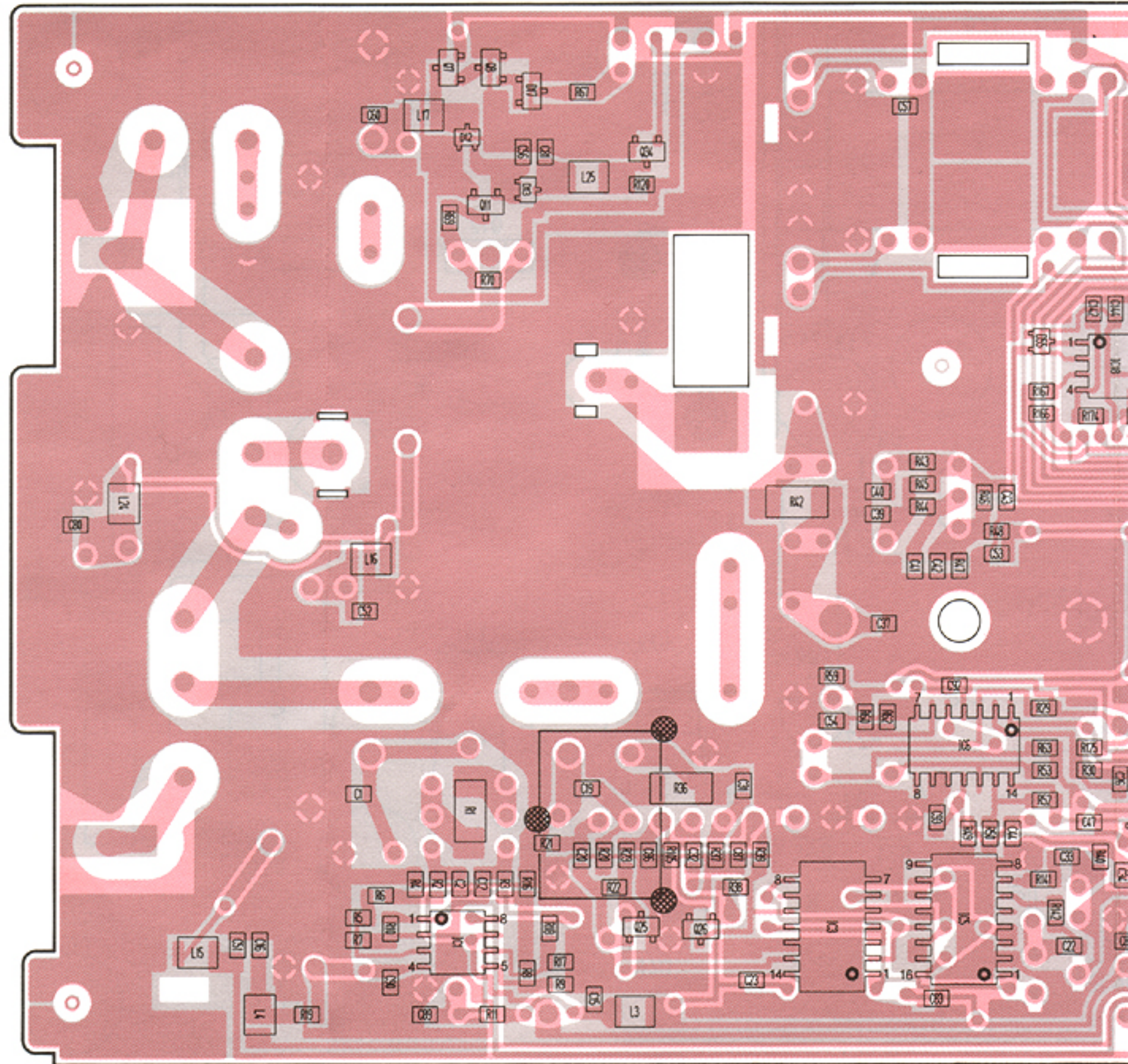

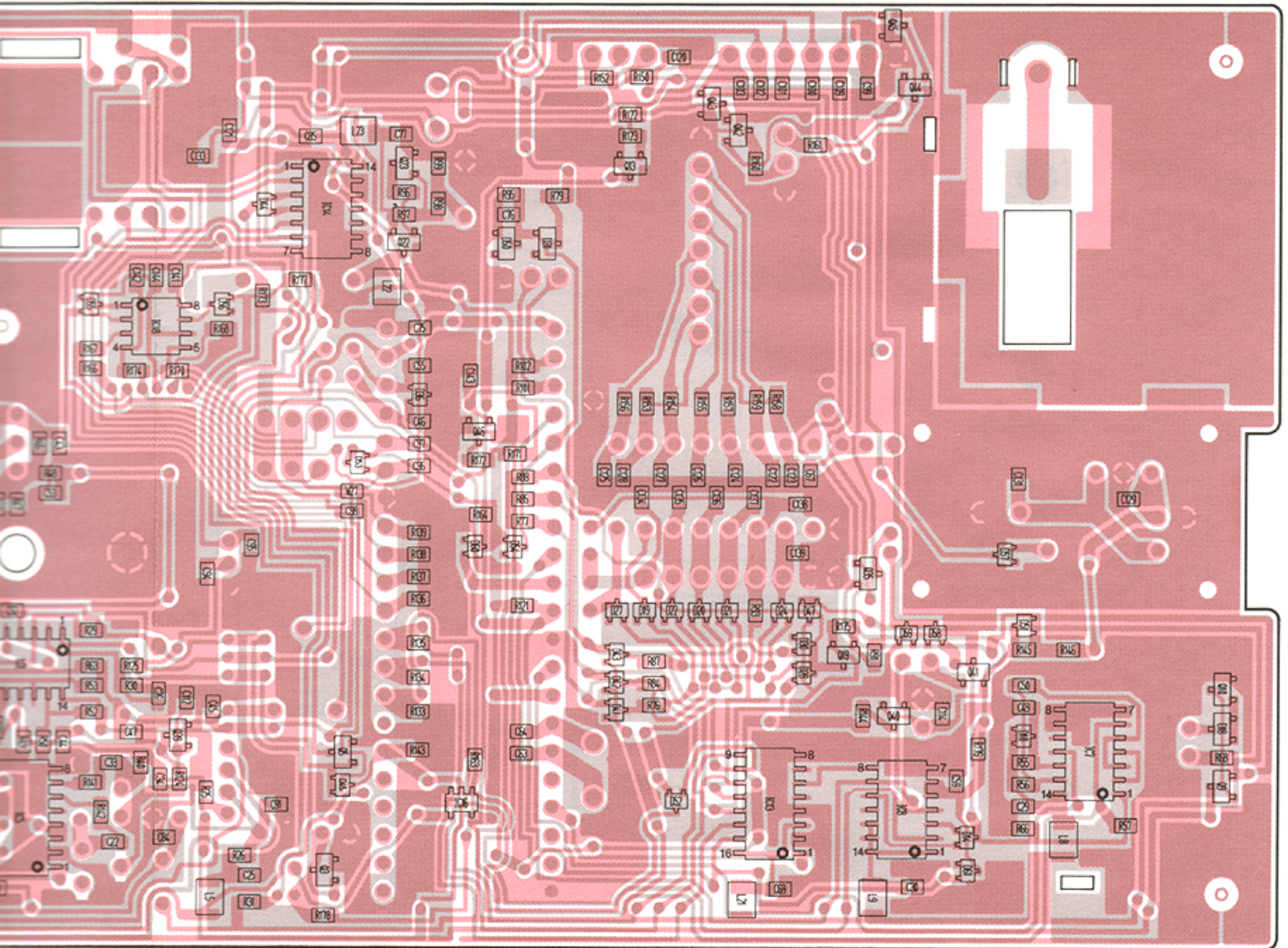

DAP202U
(Symbol: N)

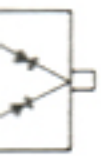

D1, D52, D53,

RD5.1M B2
(Symbol: 512)

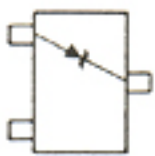

D17, D18, D50

DAP202U
(Symbol: P)

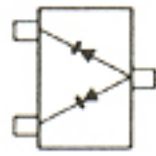

D20, D21, D24, D28,
D36, D41, D42, D43,
D54, D55, D56, D57,
D58, D61

RD6.2M B2
(Symbol: 622)

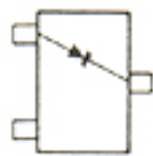

D31

8-6 TUNE AND ELEKEY UNITS

• TUNE UNIT

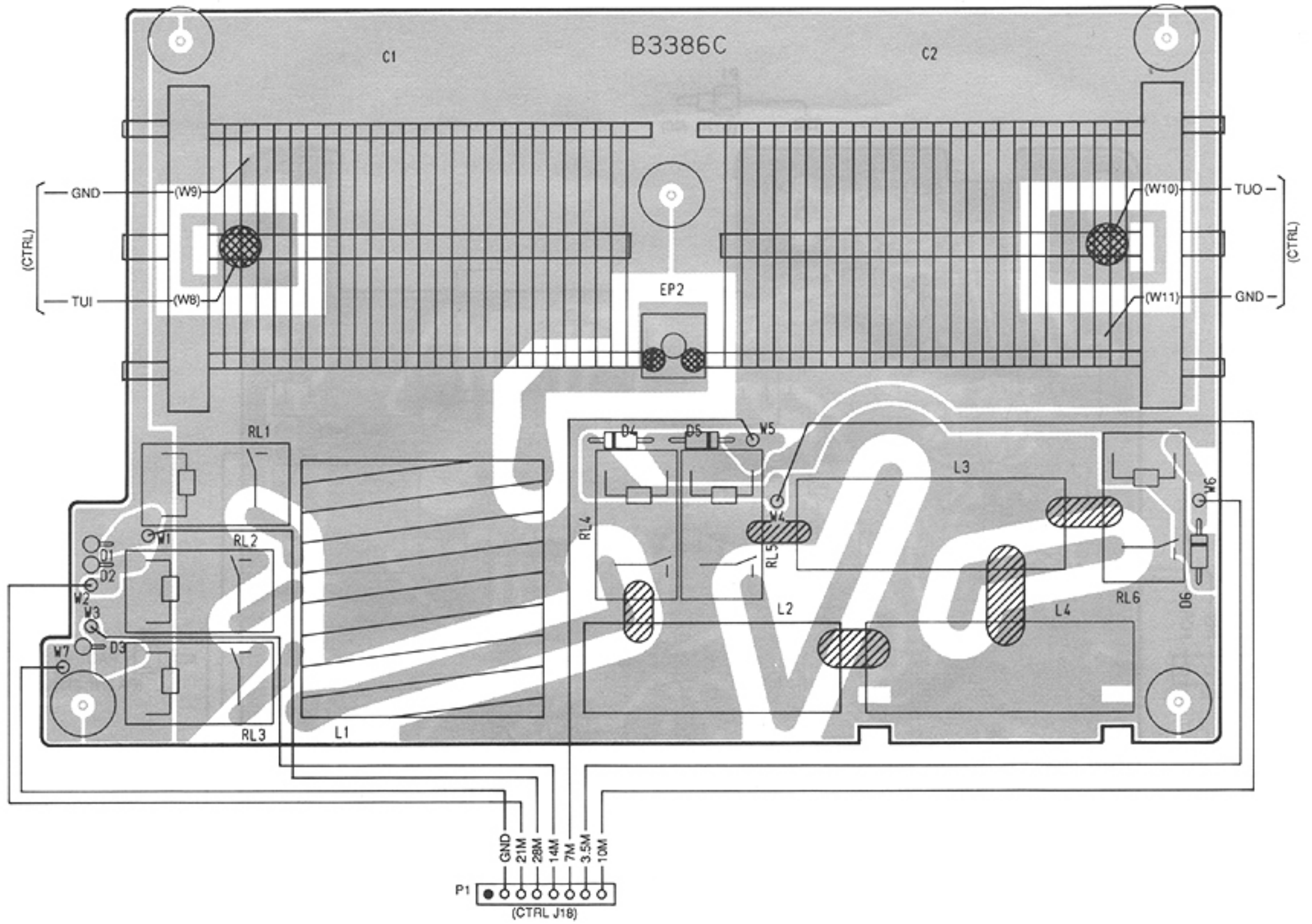

• ELEKEY UNIT

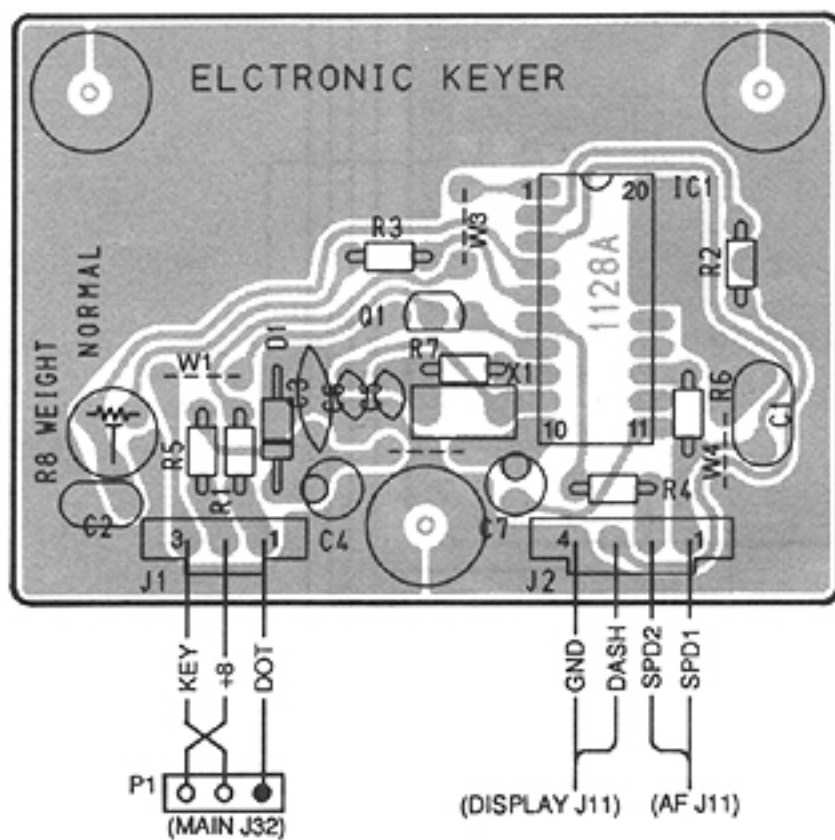

RN1204

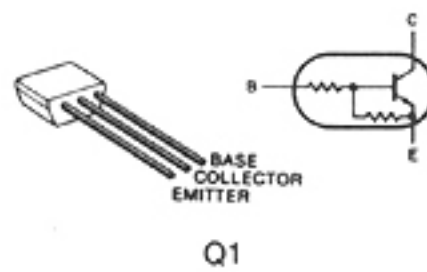

8-7 FILTER UNIT

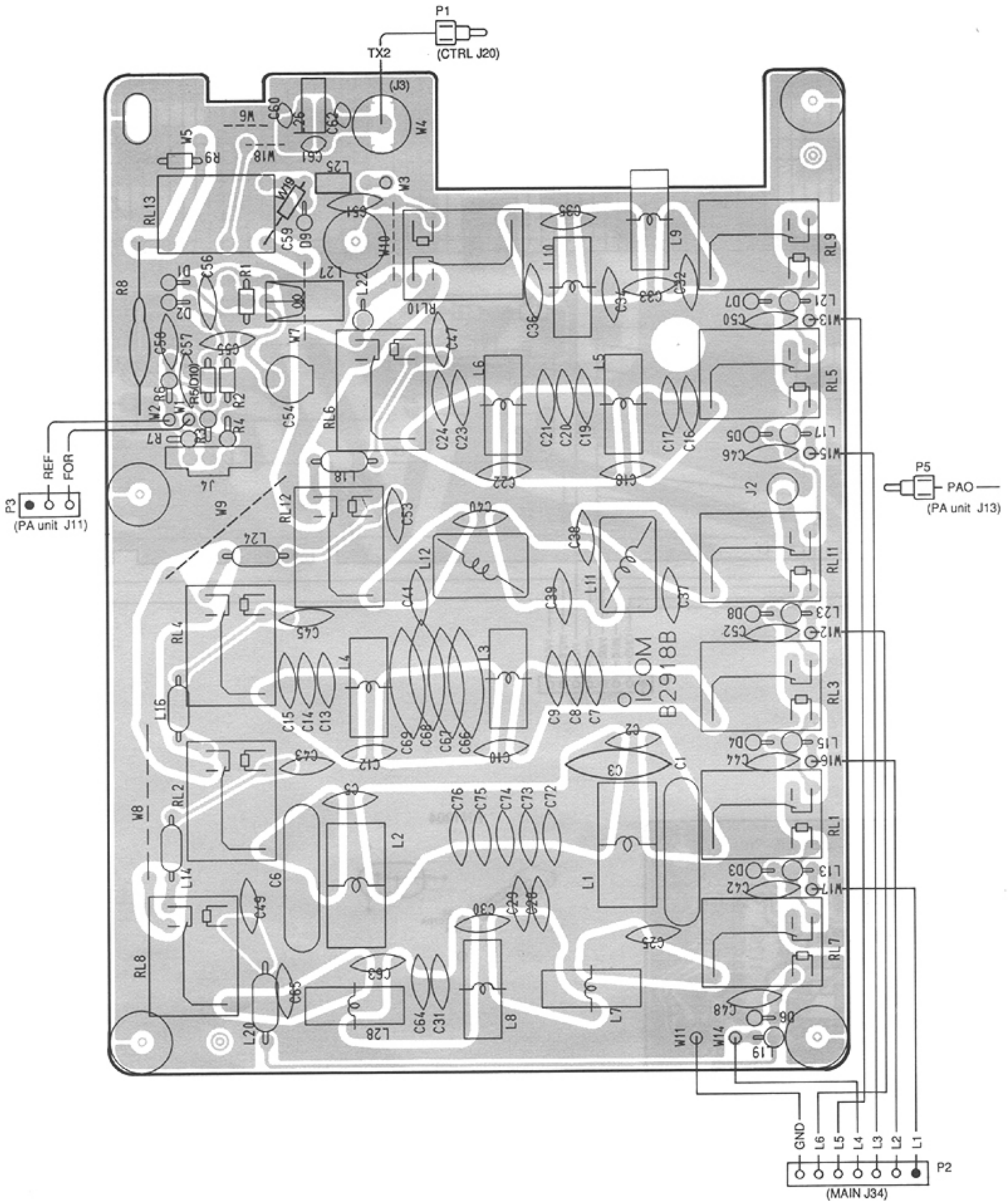

8-8 PA UNIT

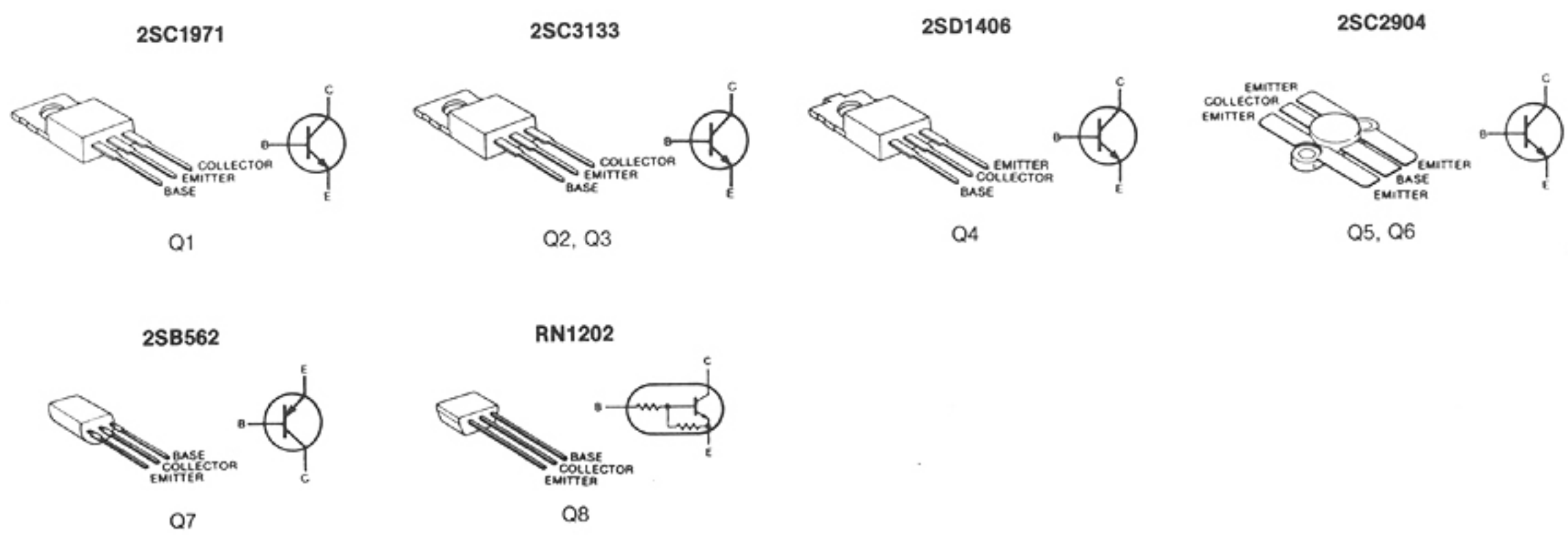
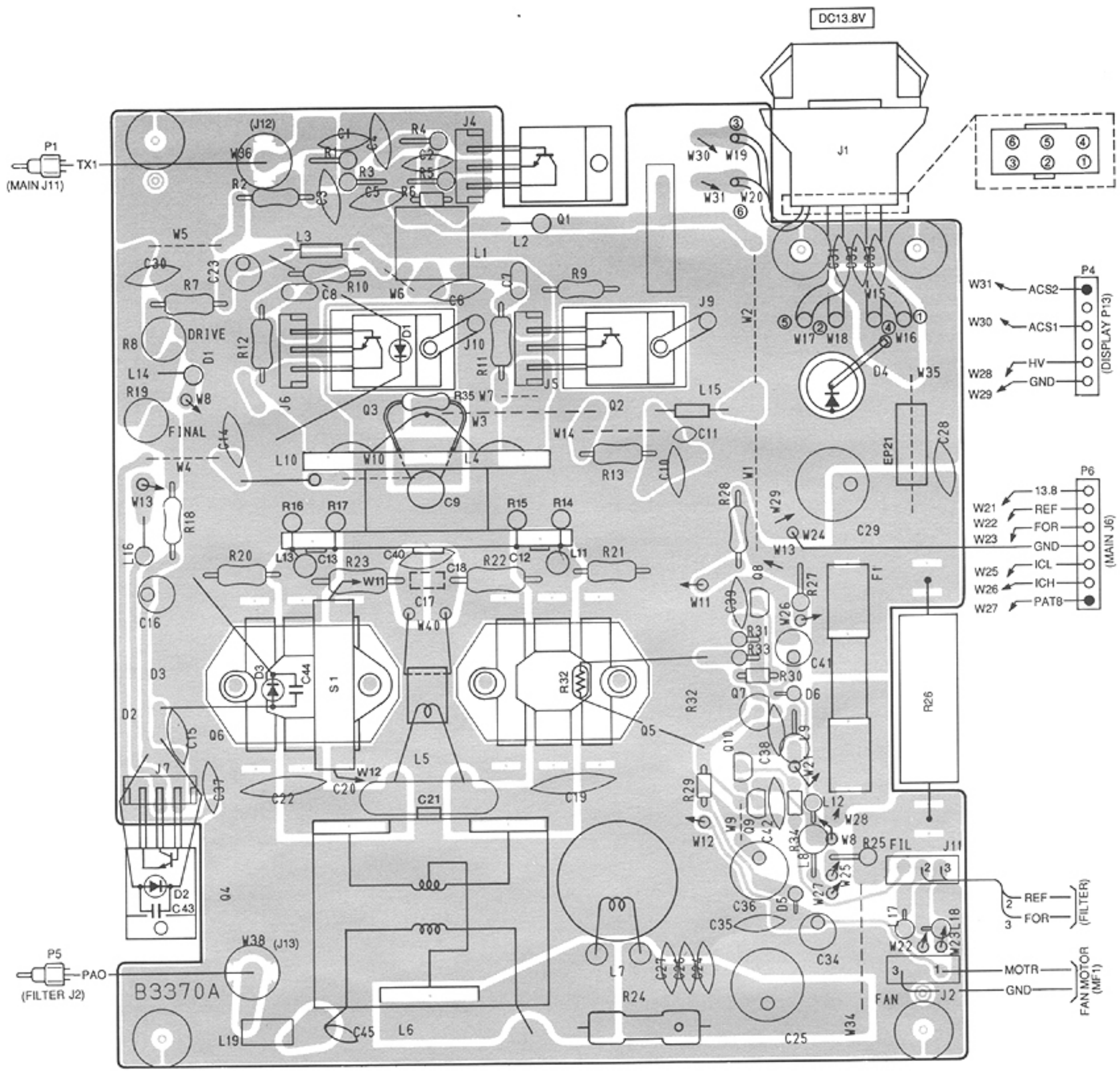

SECTION 9 BLOCK DIAGRAM

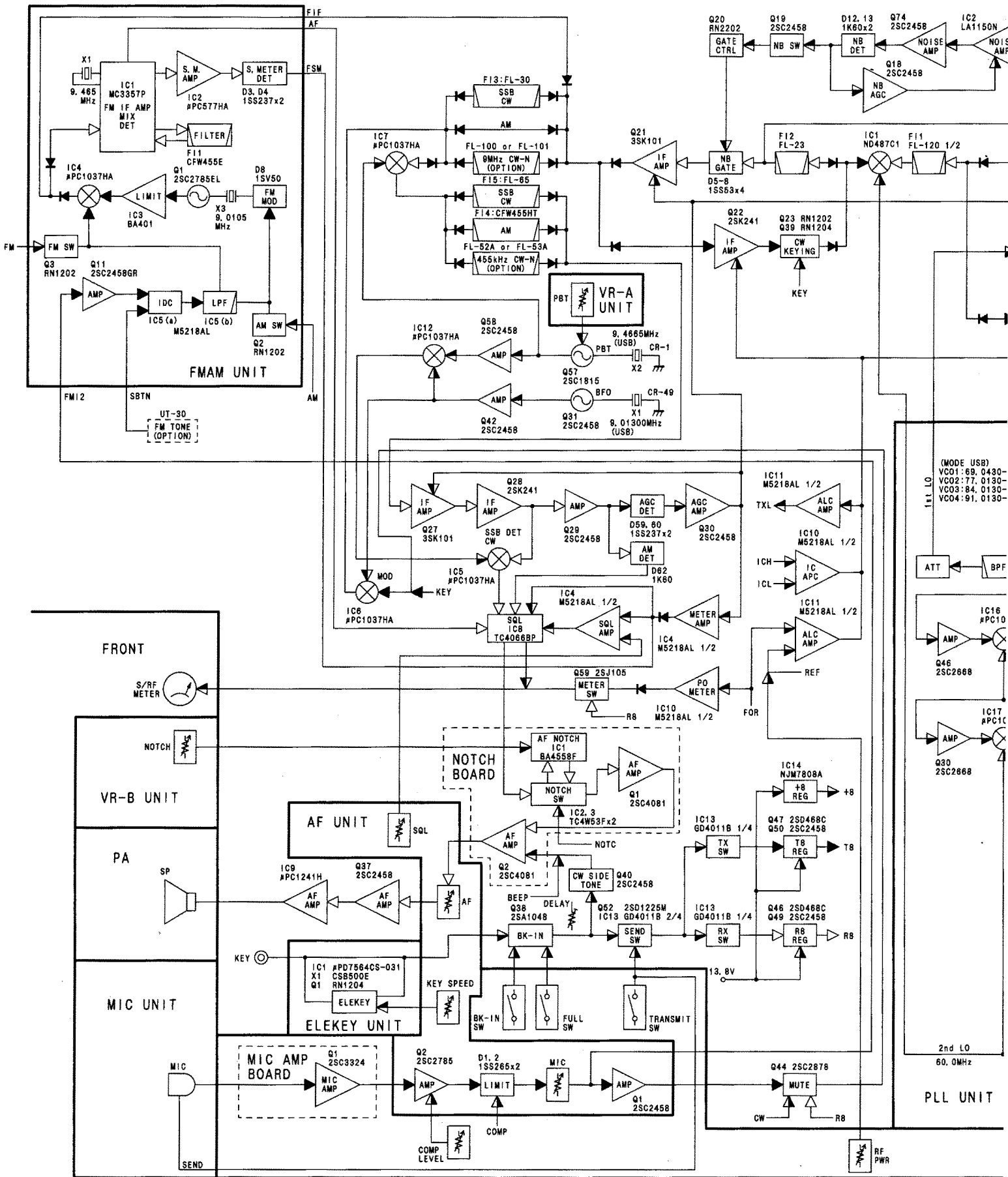

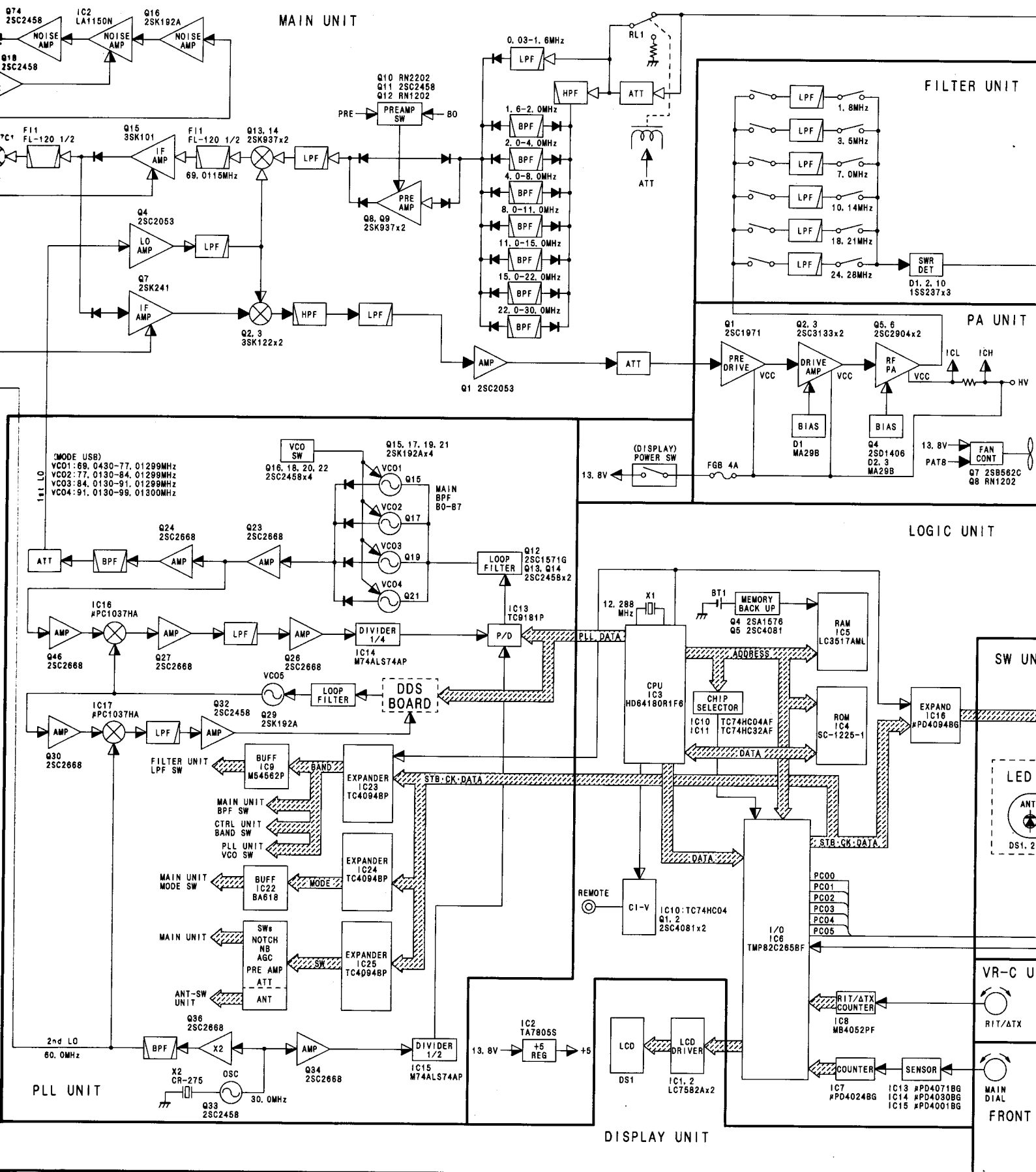

MAIN UNIT

FILTER UNIT

PA UNIT

LOGIC UNIT

PLL UNIT

DISPLAY UNIT

(MODE USB)
 VCO1: 68, 0430-77, 01299MHz
 VCO2: 77, 0130-84, 01299MHz
 VCO3: 84, 0130-91, 01299MHz
 VCO4: 91, 0130-99, 01300MHz

(DISPLAY)
 POWER SW

LED
 ANT
 DS1, 2

VR-C U
 RIT/ATX

MAIN DIAL

FRONT

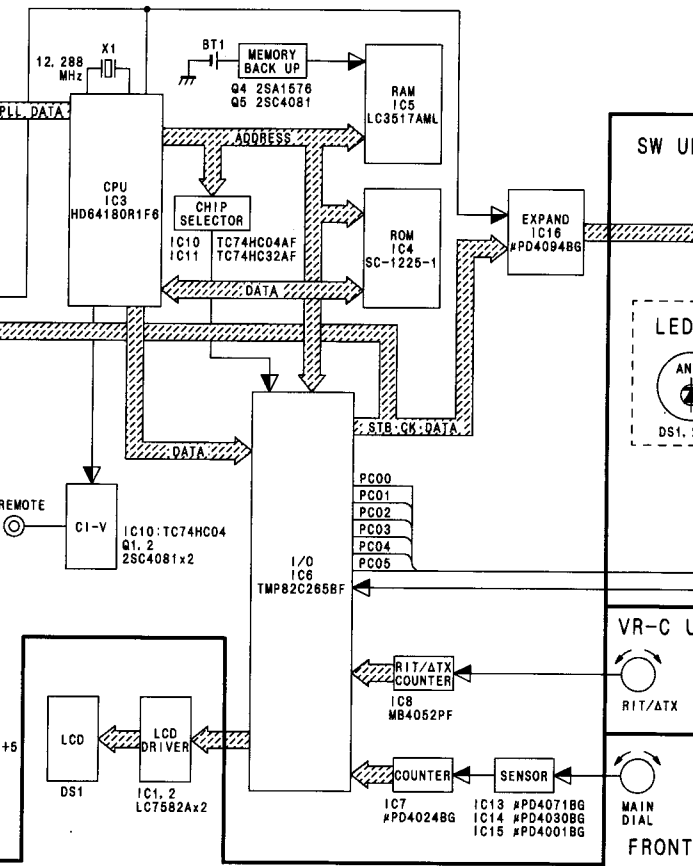
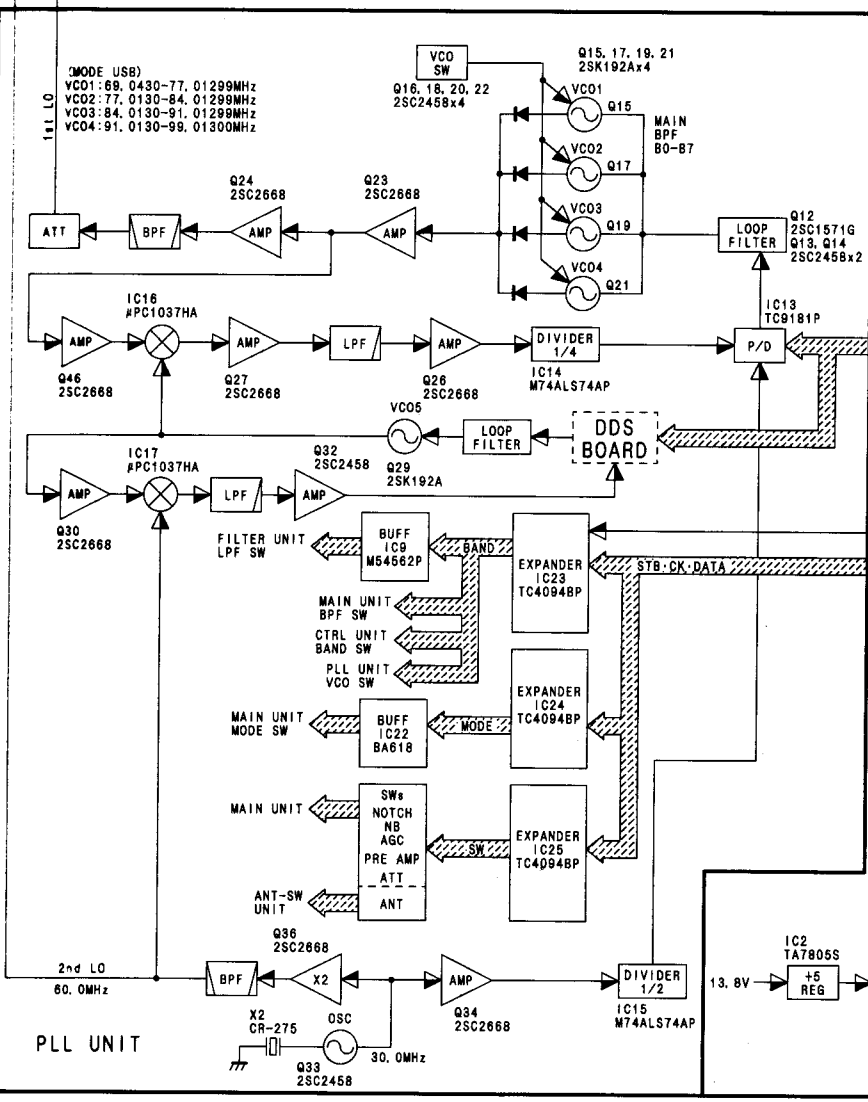
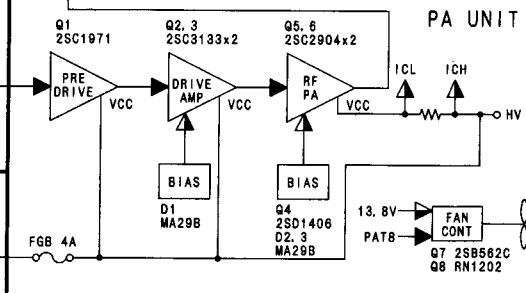
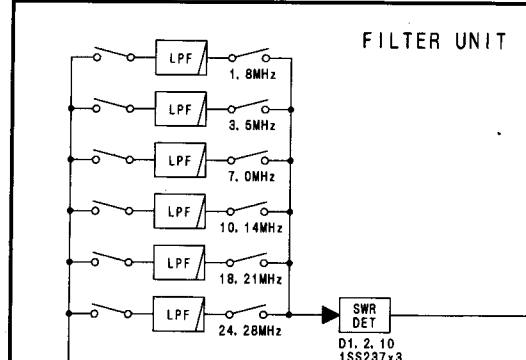
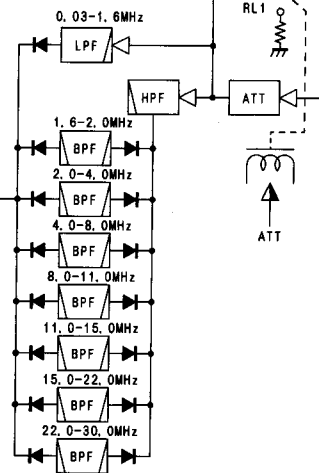
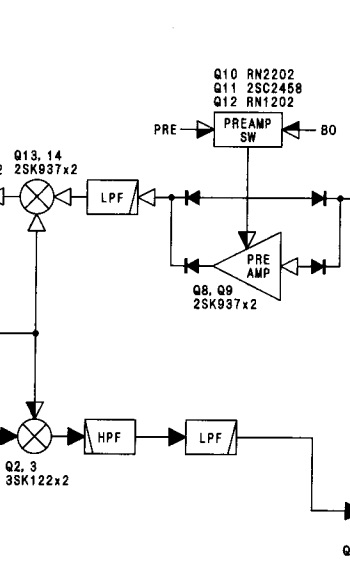
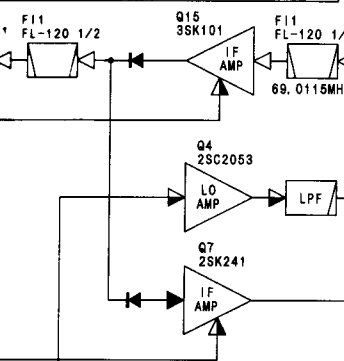
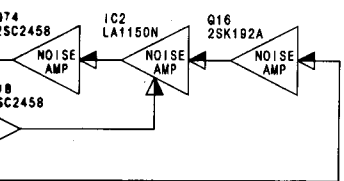

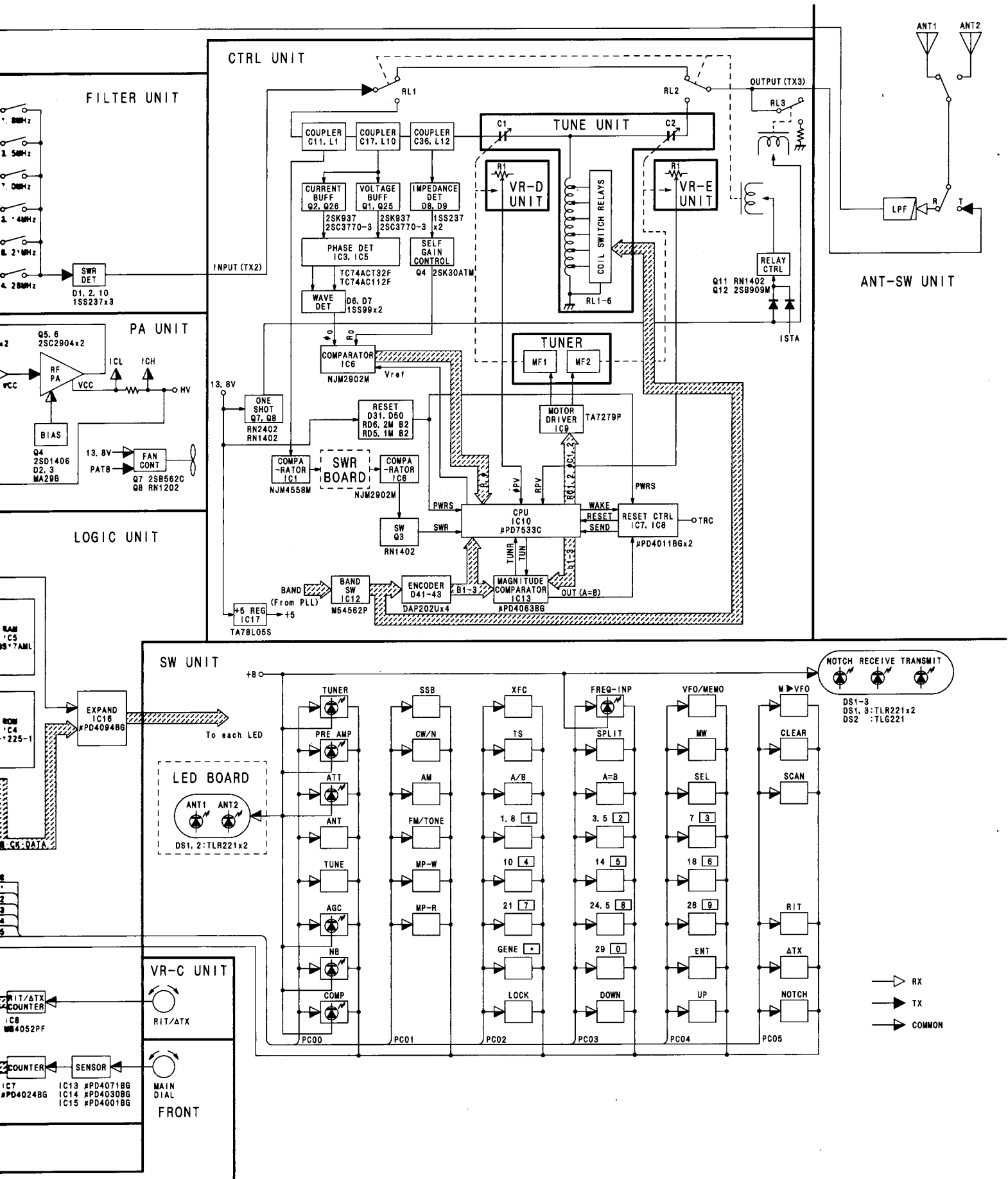

SECTION 10 VOLTAGE DIAGRAM

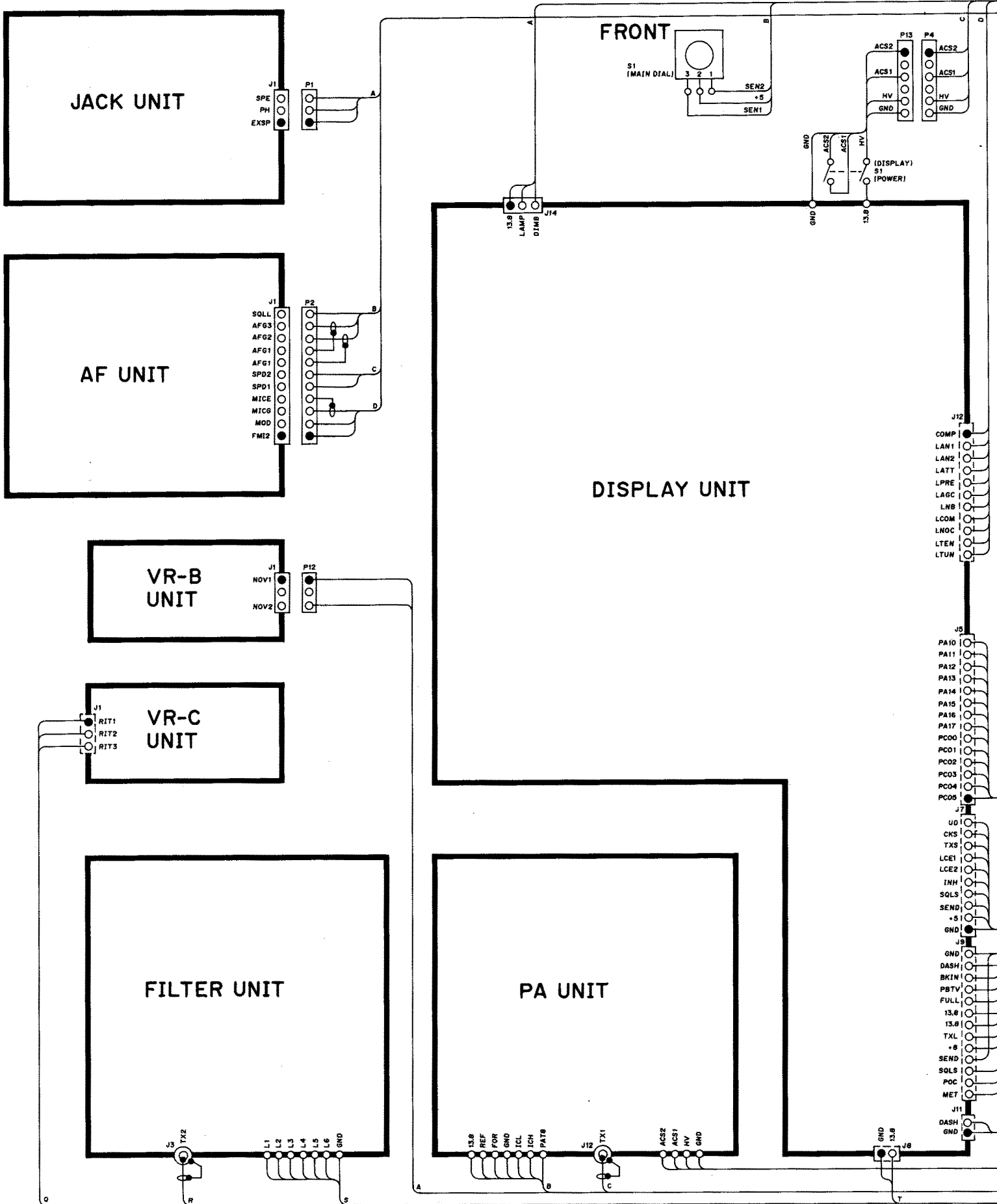

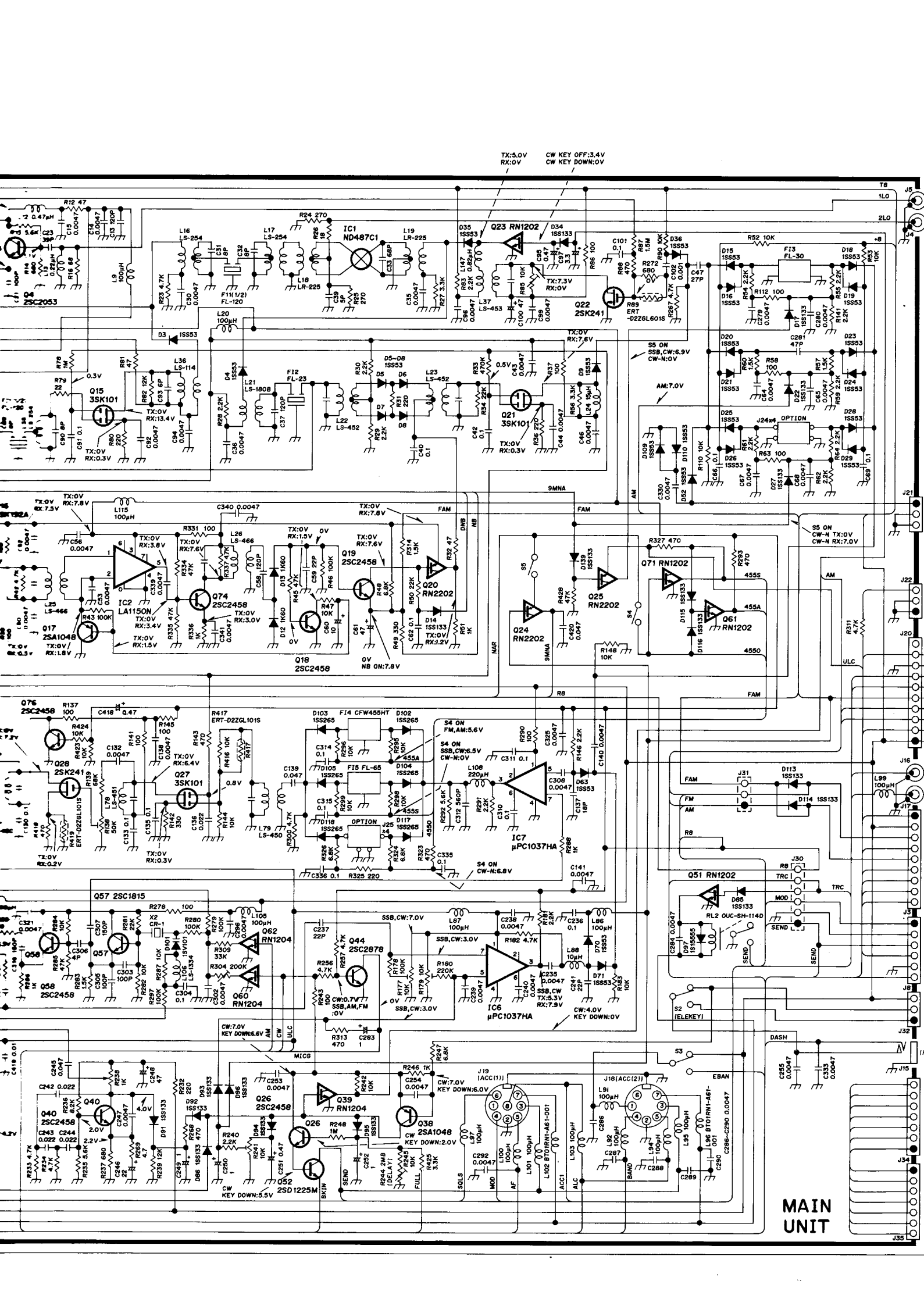

TX:5.0V
RX:0V
CW KEY OFF:3.4V
CW KEY DOWN:0V

MAIN UNIT

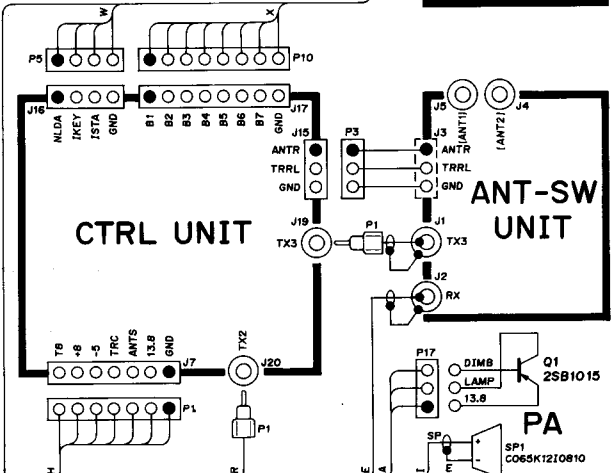
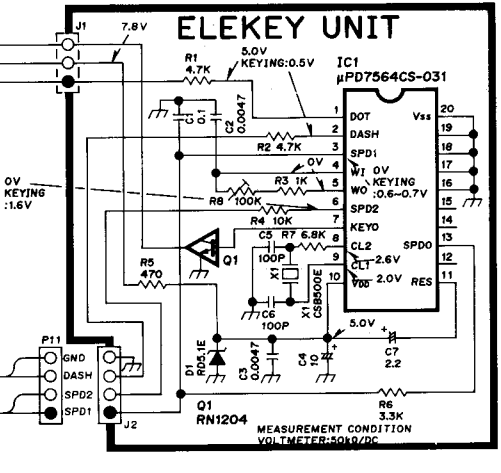
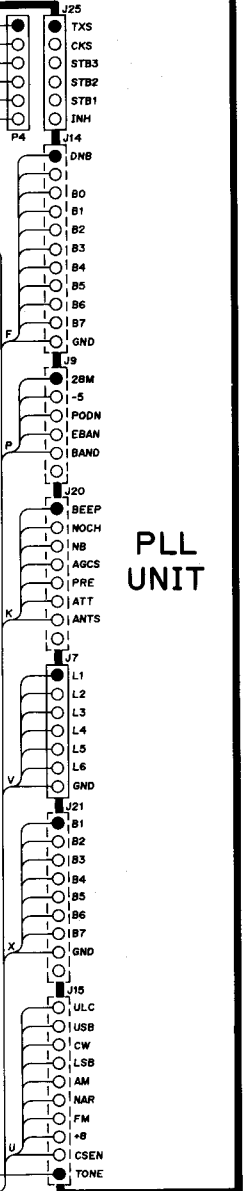
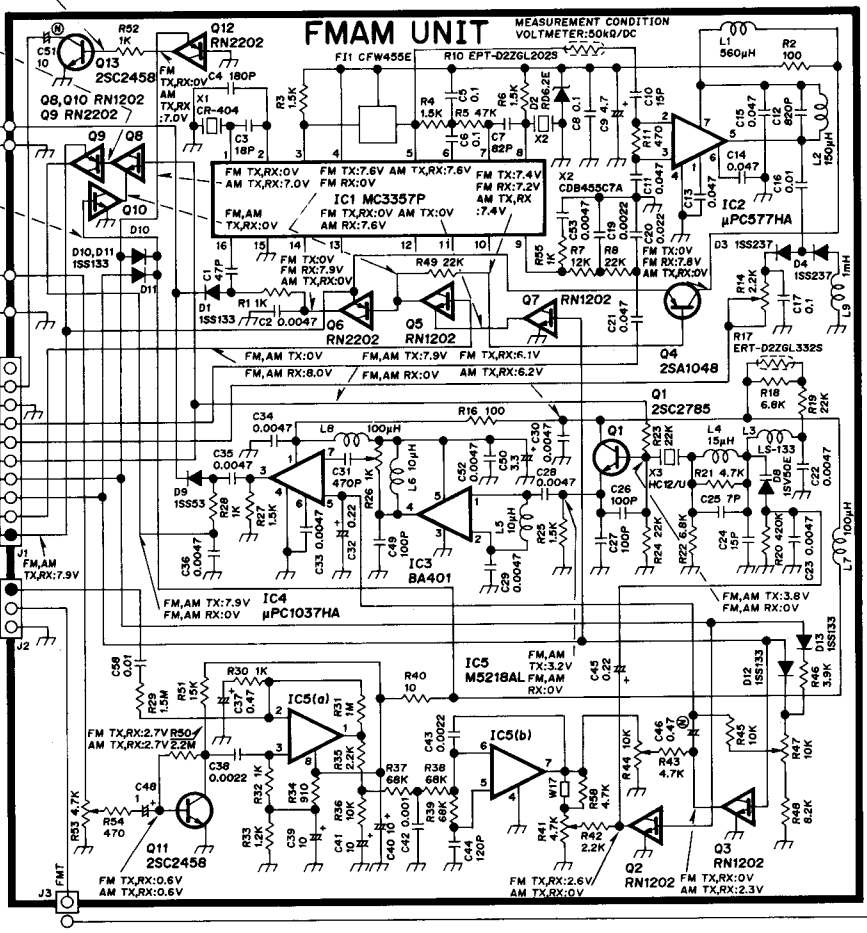
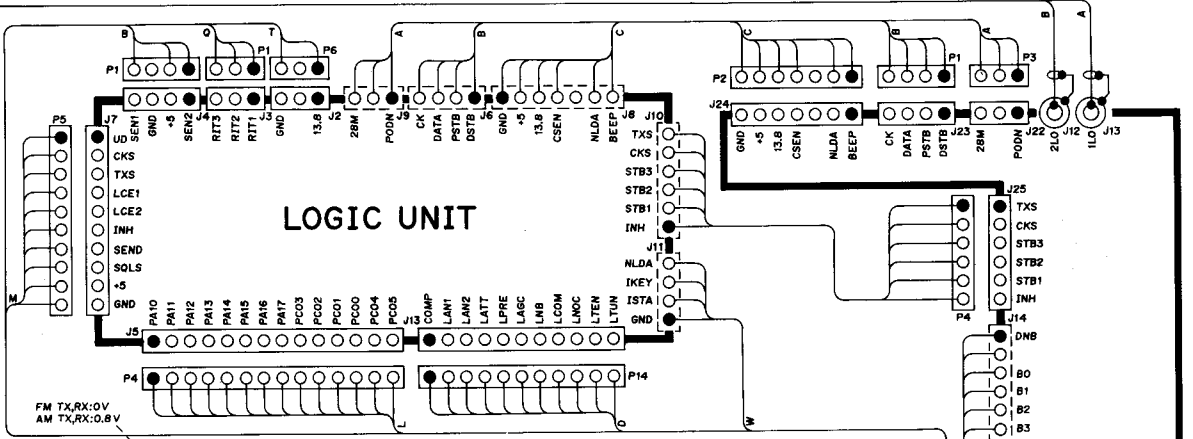
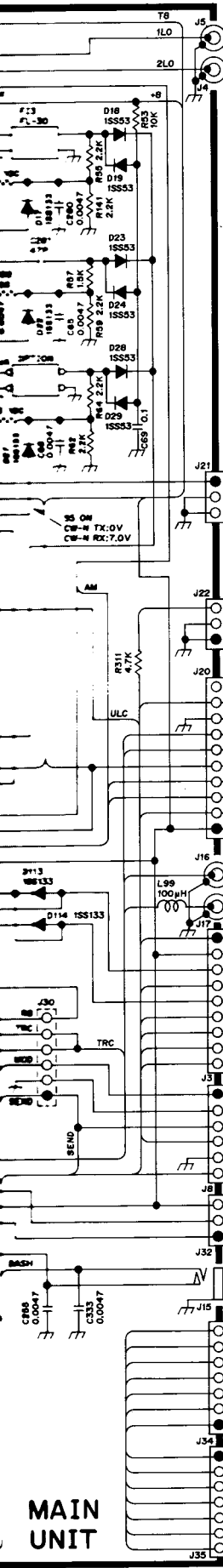

FREQUENCY	VOLTAGE	VCO	VOLTAGE
0.03000-1.99999MHz	Pin 1	VCO1	3.3V
1.60000-3.99999MHz	Pin 2		
2.00000-3.99999MHz	Pin 3		
4.00000-7.99999MHz	Pin 4	VCO2	3.8V
8.00000-10.99999MHz	Pin 5		
11.00000-14.99999MHz	Pin 6	VCO3	4.3V
15.00000-21.99999MHz	Pin 8	VCO4	
22.00000-30.00000MHz	Pin 8		

FREQUENCY	VOLTAGE	VCO	VOLTAGE
0.03000-1.99999MHz	Pin 3	VCO1	3.3V
1.60000-3.99999MHz	Pin 4		
2.00000-3.99999MHz	Pin 5		
4.00000-7.99999MHz	Pin 6	VCO2	3.8V
8.00000-10.99999MHz	Pin 7		
11.00000-14.99999MHz	Pin 8	VCO3	4.3V
15.00000-21.99999MHz	Pin 9		
22.00000-30.00000MHz	Pin 10	VCO4	

FREQUENCY	VOLTAGE	VCO	VOLTAGE
0.03000-1.99999MHz	7.2V	VCO1	3.3V
1.60000-3.99999MHz	6.2V		
2.00000-3.99999MHz	5.2V		
4.00000-7.99999MHz	0V	VCO2	3.8V
8.00000-10.99999MHz	4.2V		
11.00000-14.99999MHz	3.3V	VCO3	4.3V
15.00000-21.99999MHz	2.9V	VCO4	
22.00000-30.00000MHz			

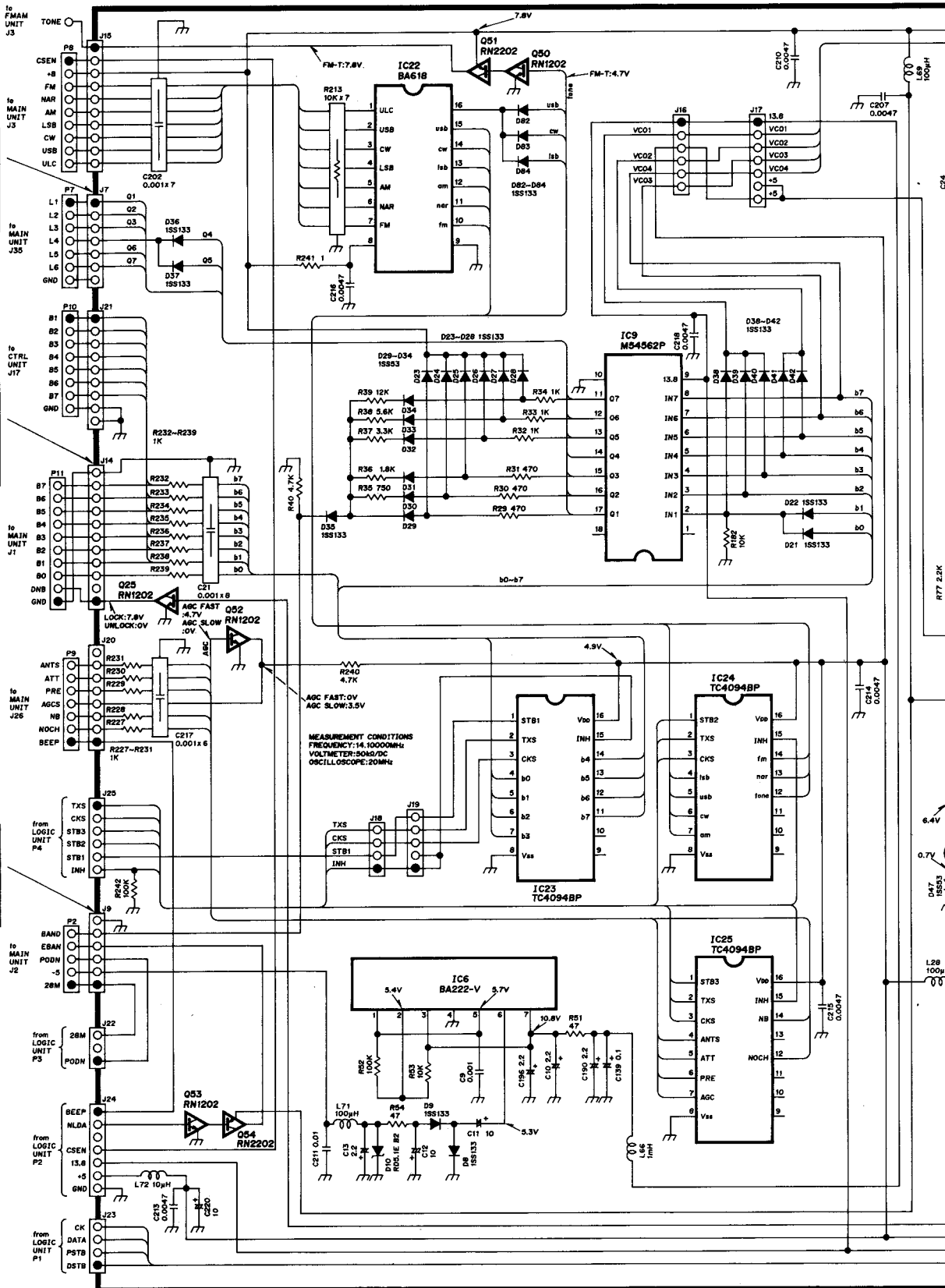

MEASUREMENT CONDITIONS
 FREQUENCY: 14.10000MHz
 VOLTMETER: 50kΩ/DC
 OSCILLOSCOPE: 20MHz

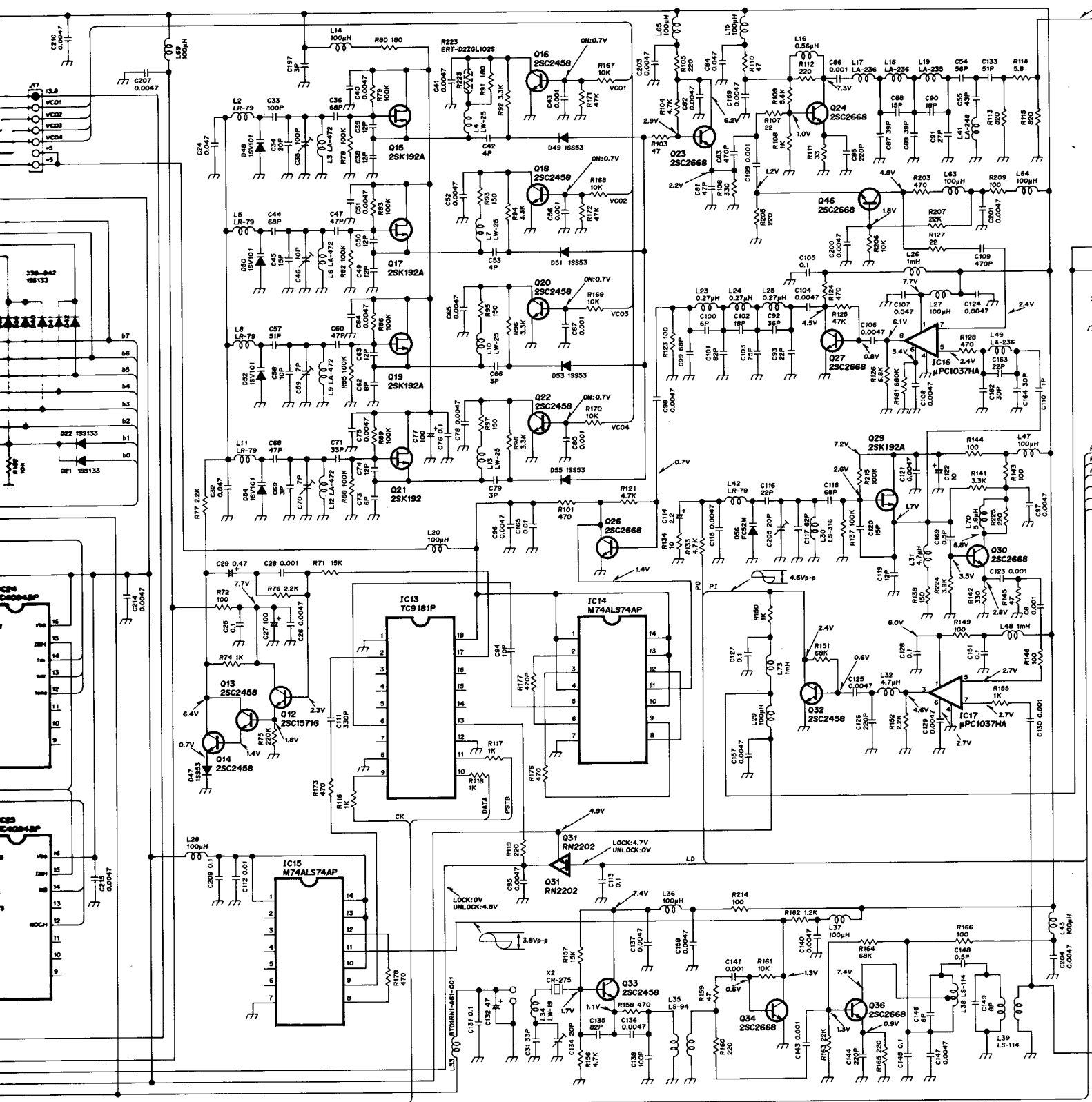

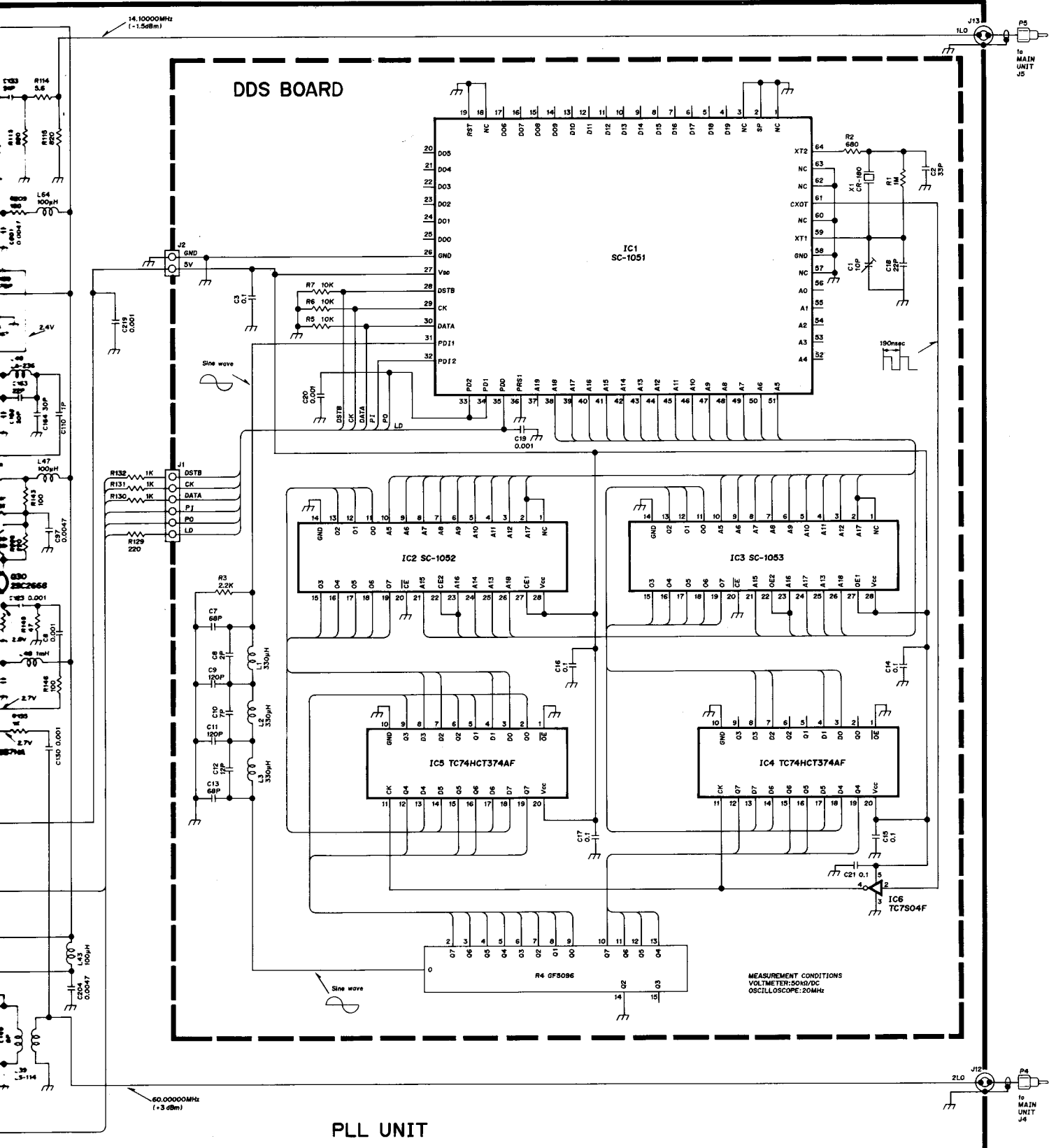

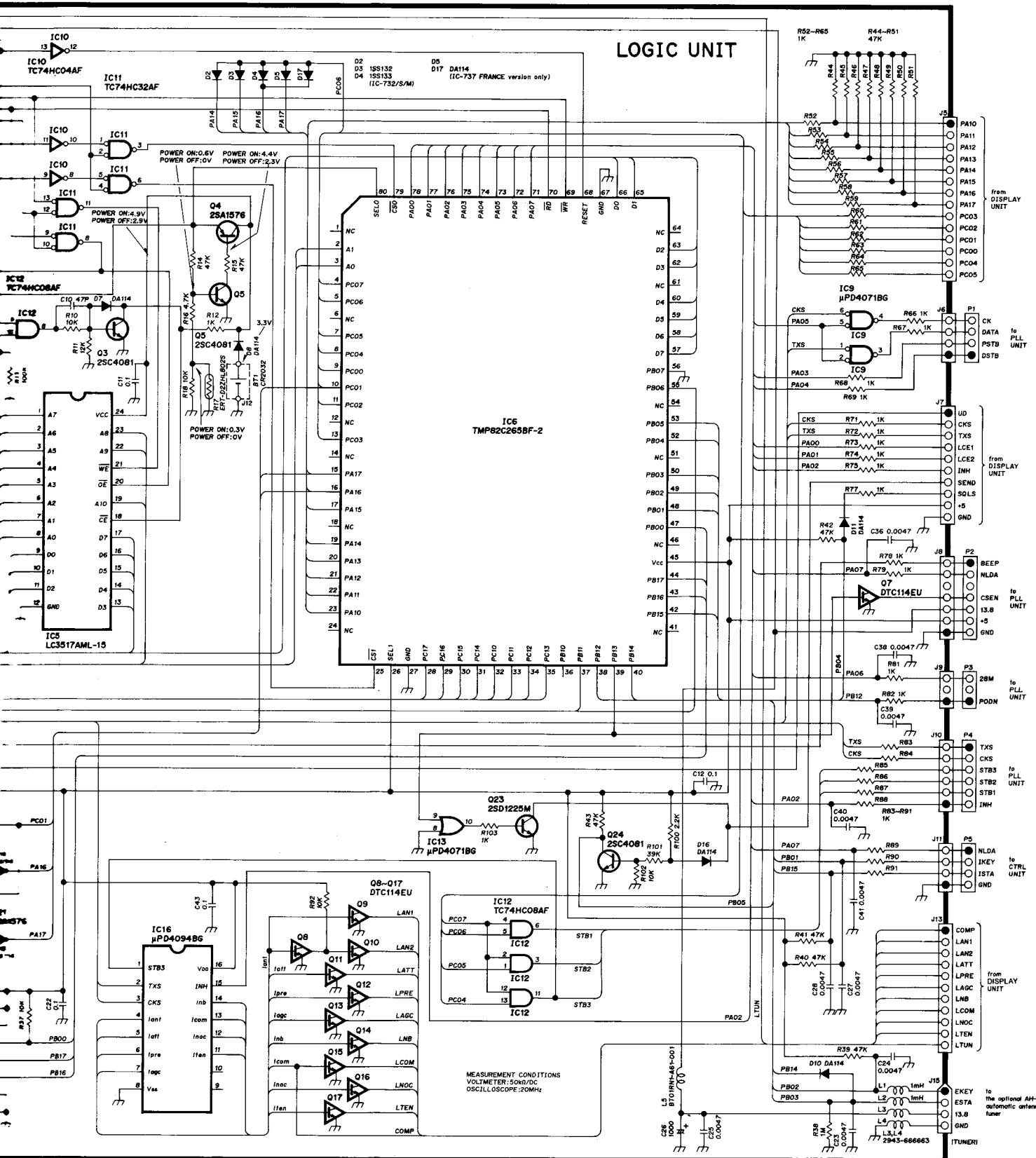

LOGIC UNIT

IC6
TMP82C2658F-2

MEASUREMENT CONDITIONS
VOLTMETER: 50kΩ/DC
OSCILLOSCOPE: 20MHz

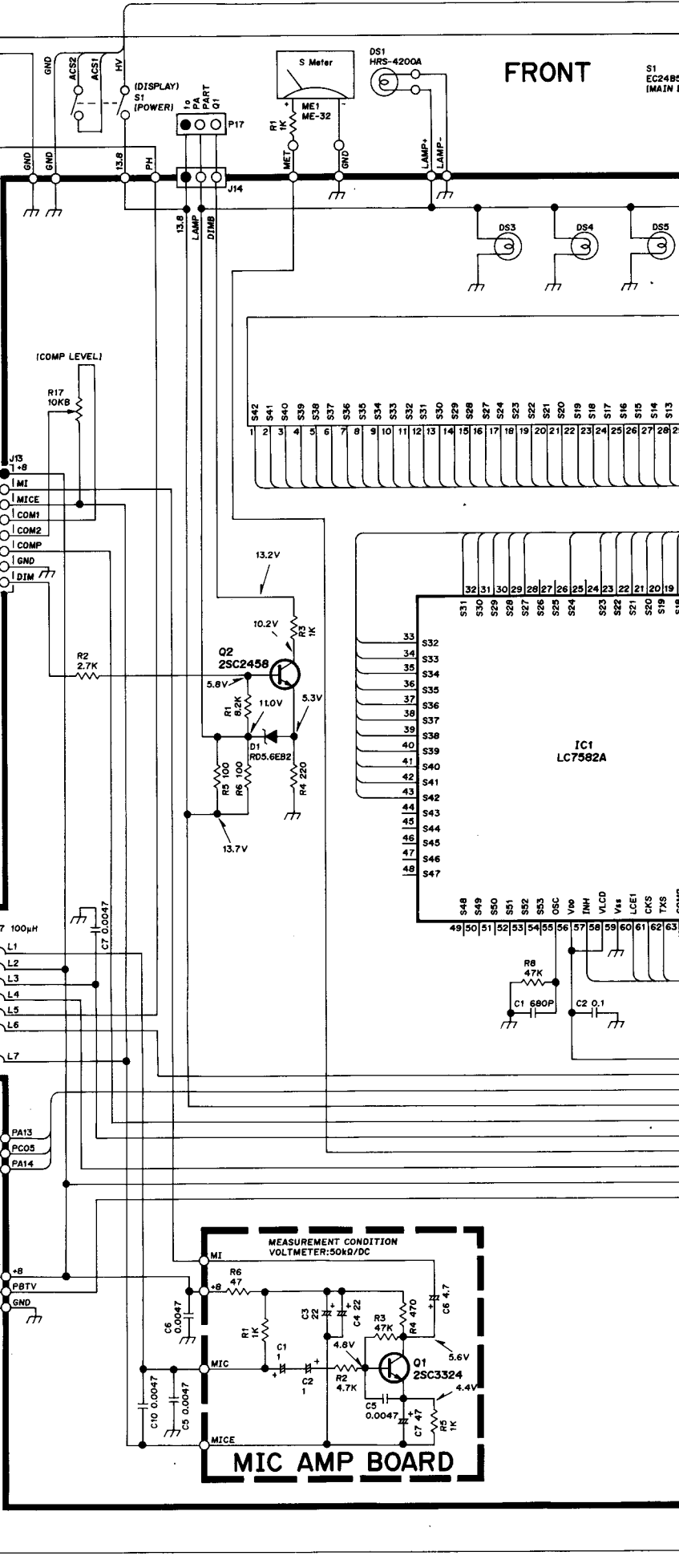
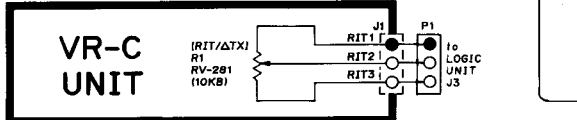
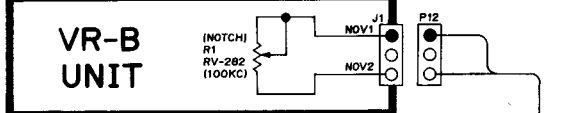
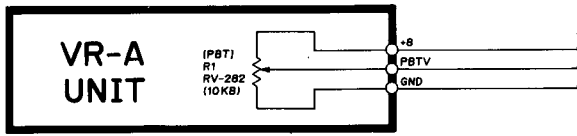
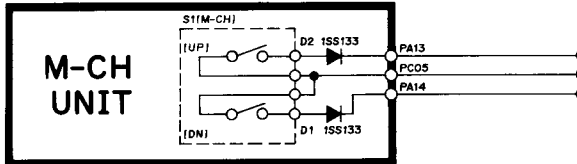
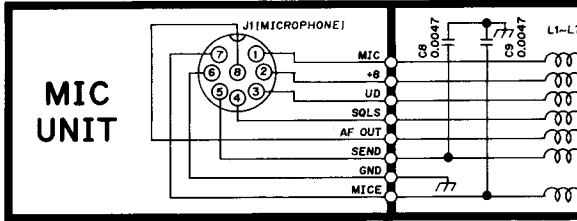
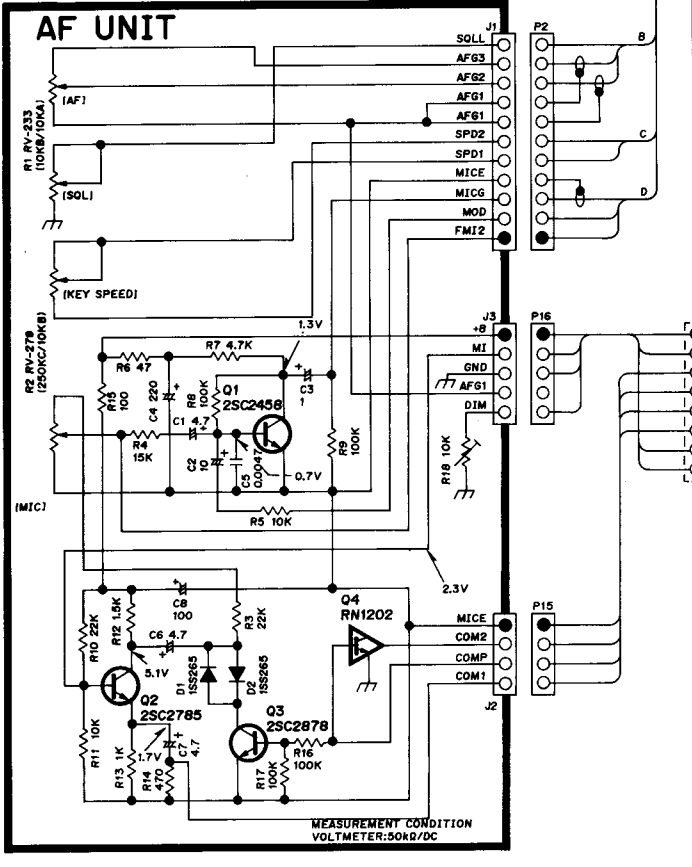
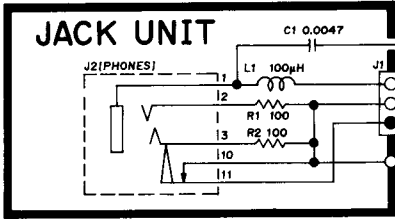

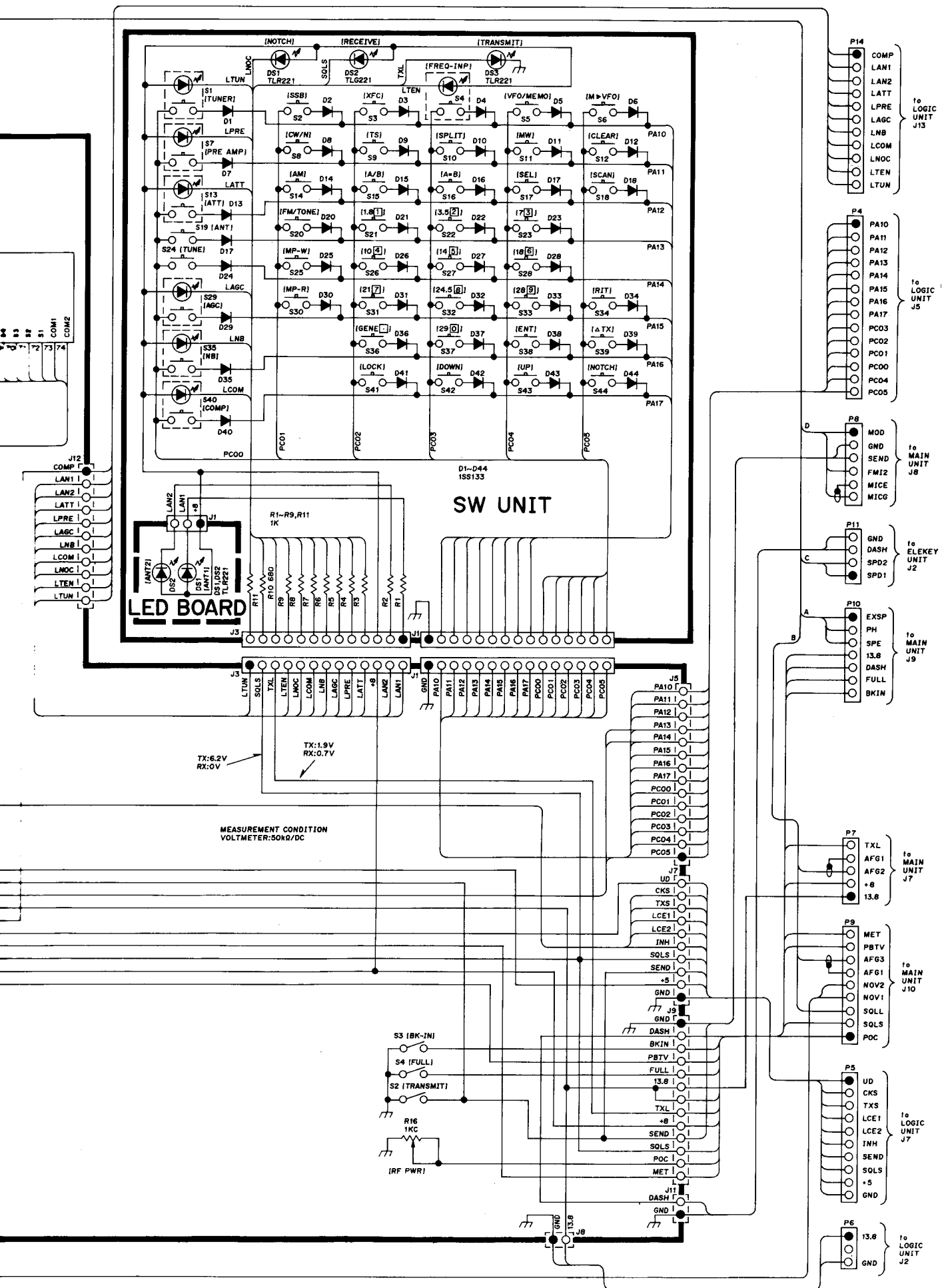

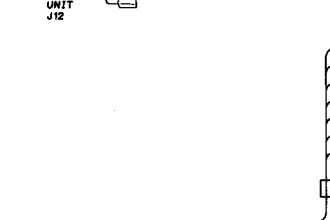
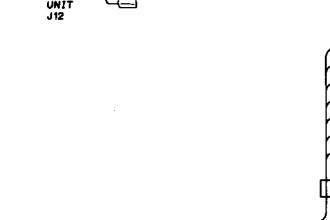
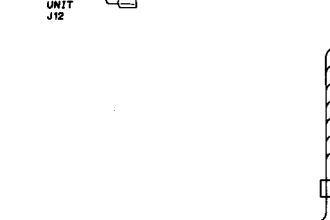
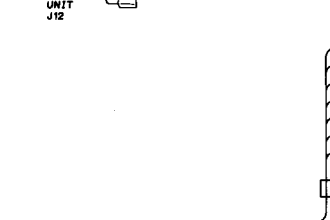
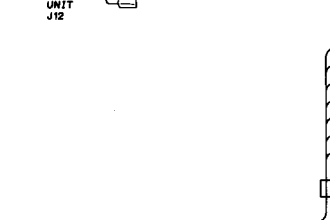
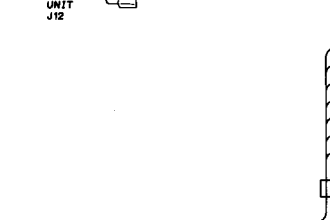
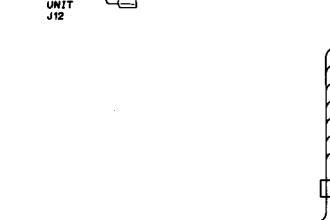
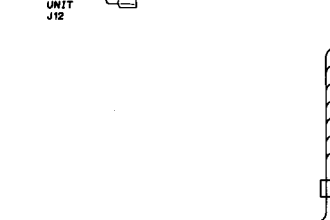
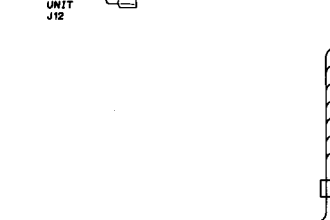
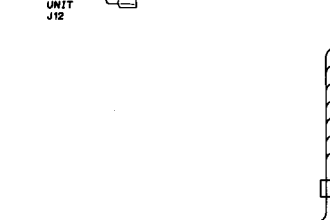
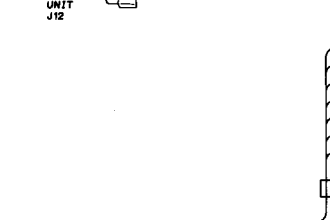
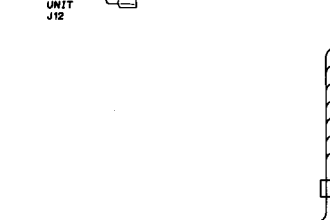
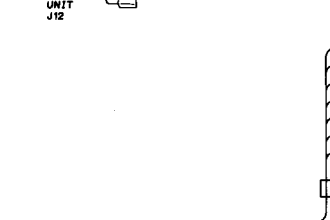
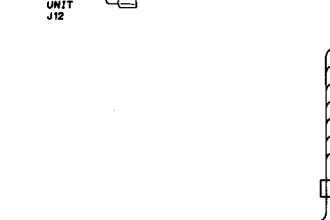
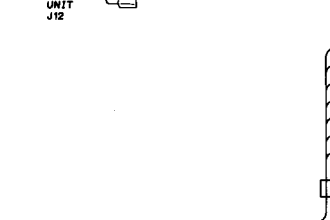
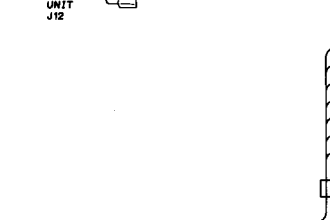
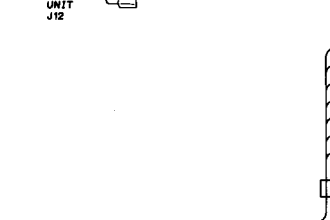
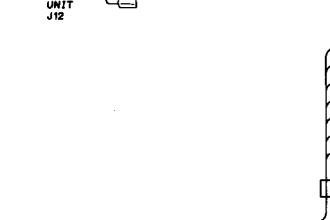
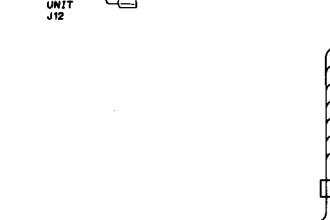
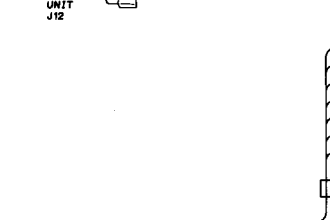
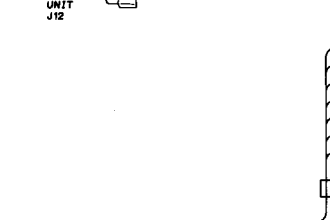
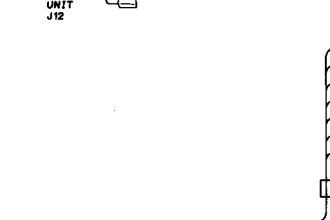
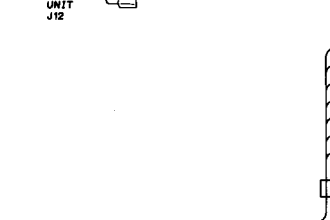
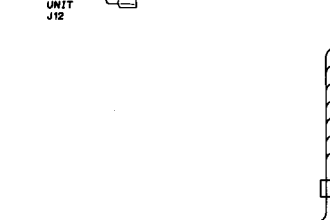
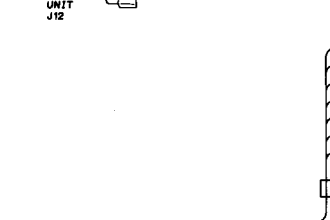
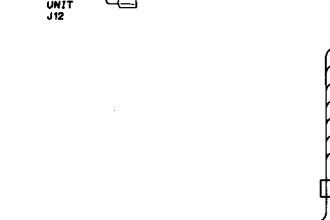
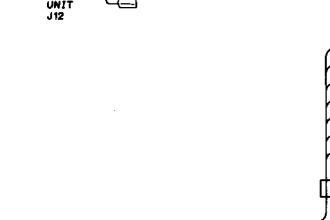
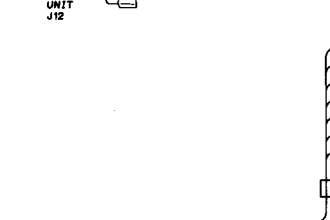
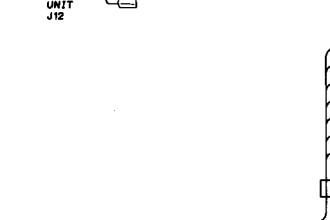
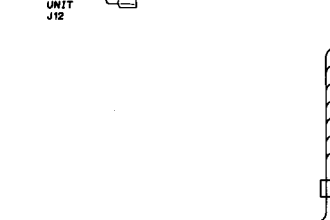
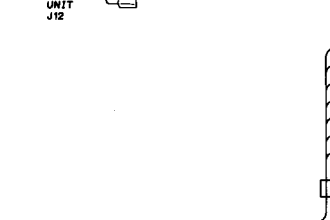
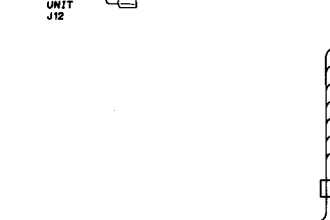
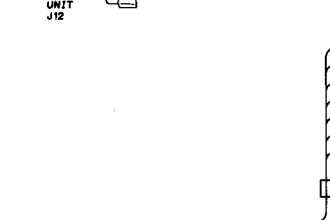
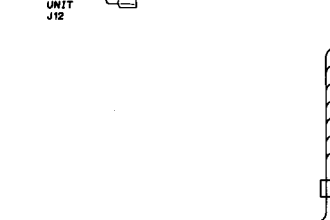
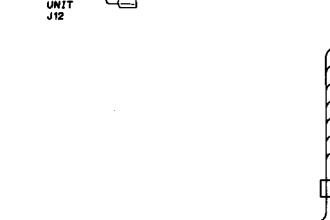
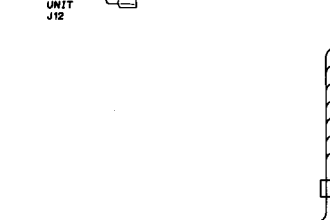
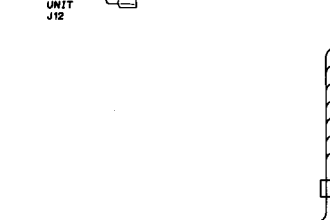
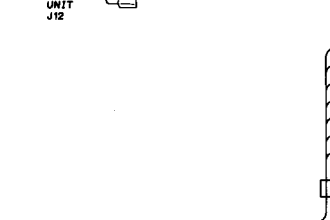
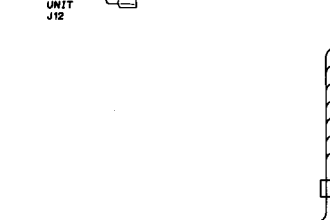
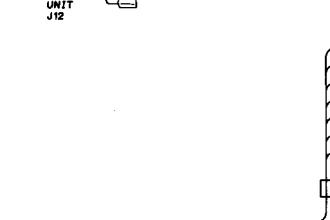
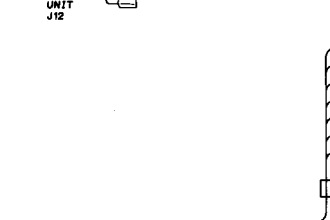
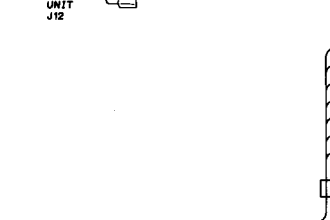
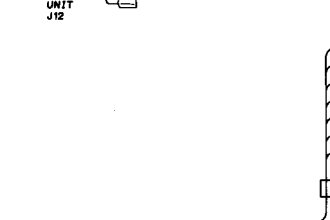
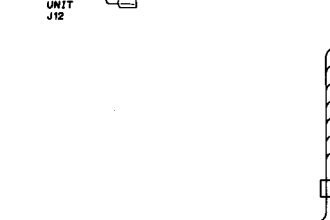
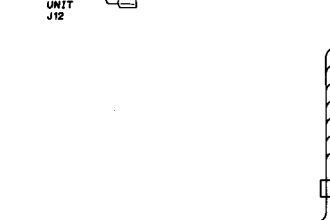
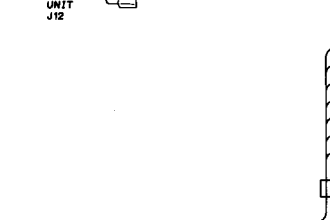
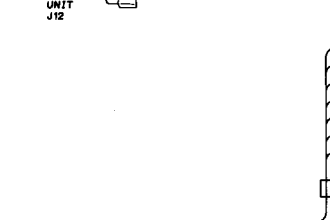
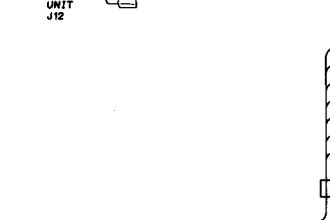
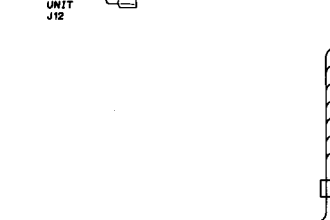
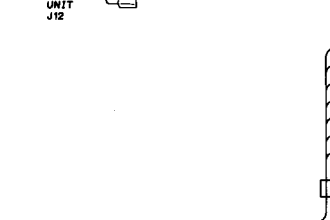
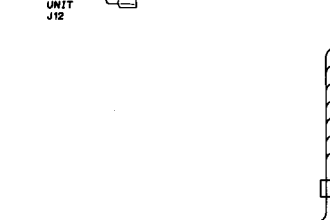
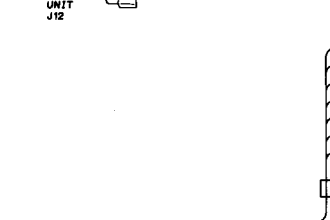
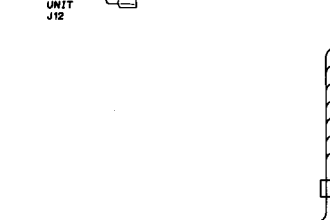
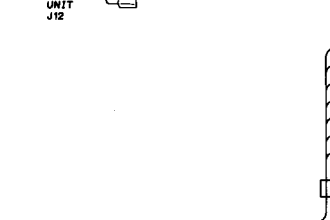
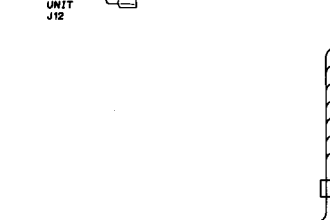
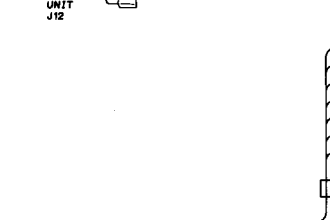
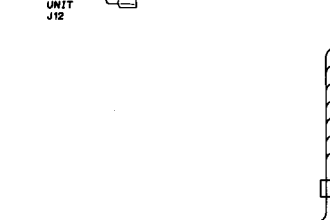
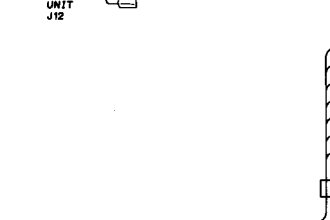
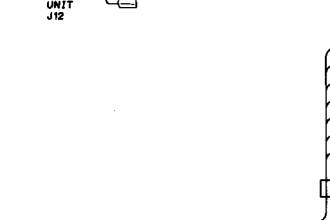
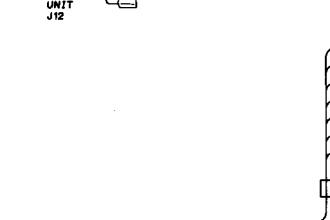
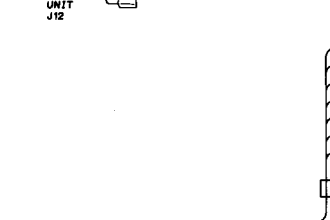
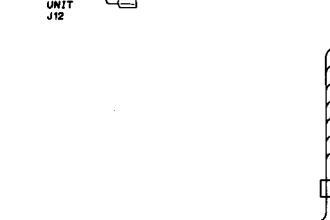
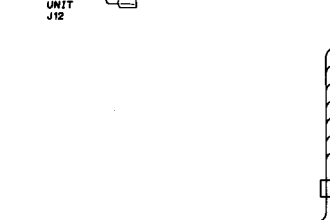
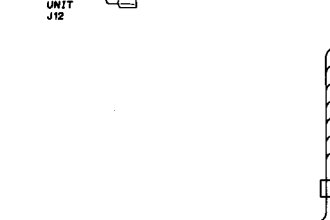
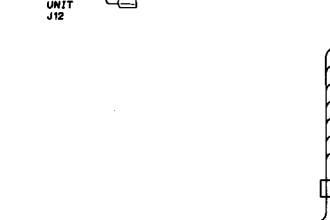
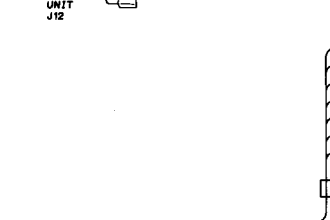
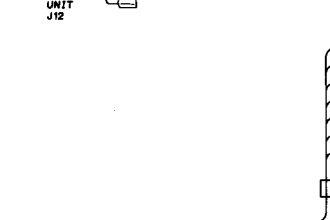
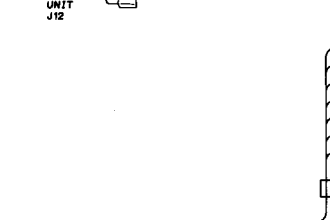
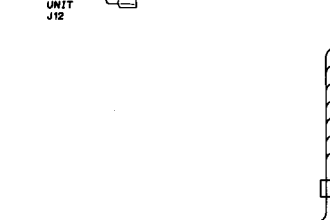
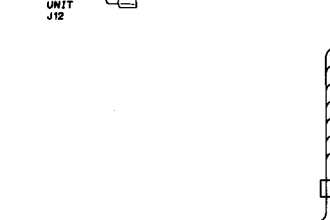
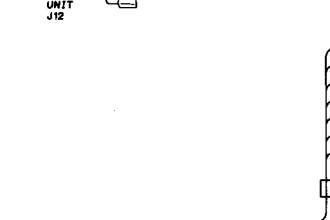
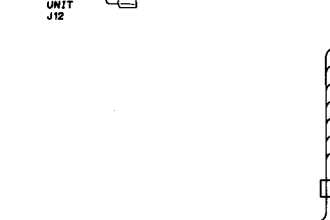
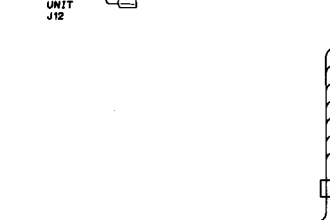
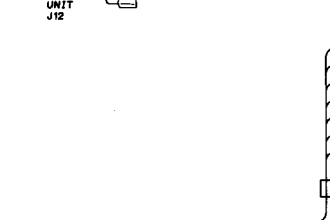
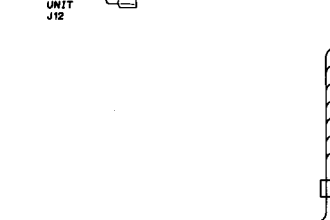
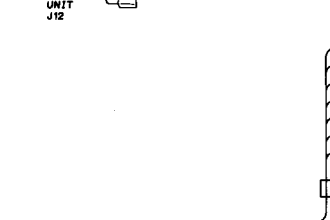
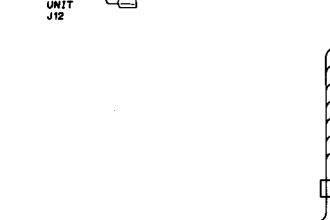
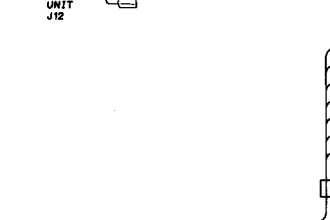
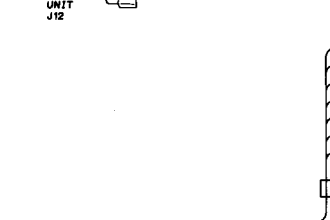
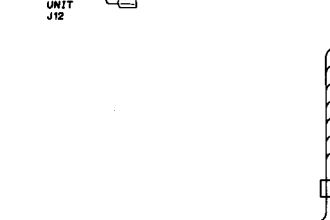
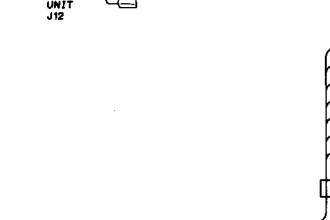
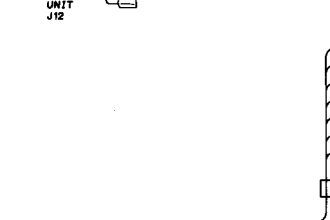
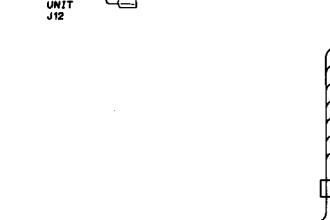
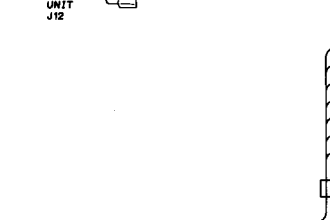
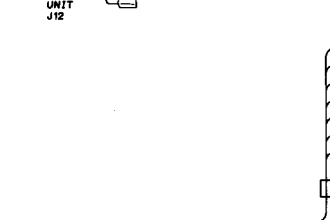
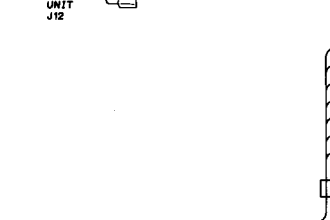
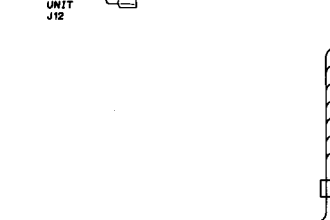
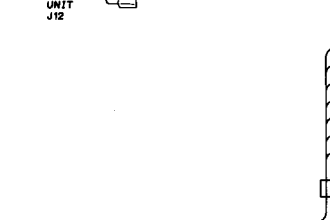
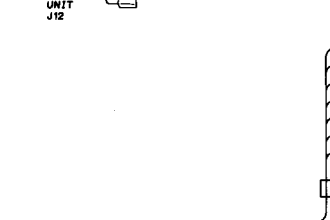
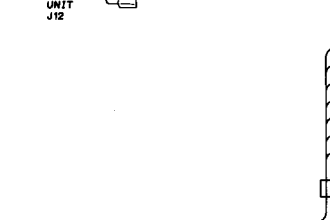
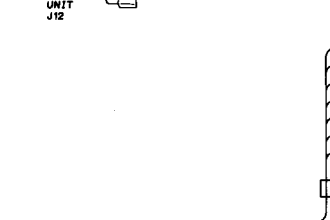
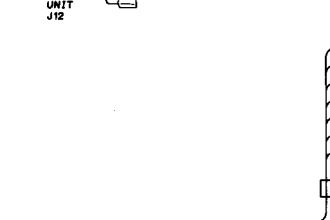
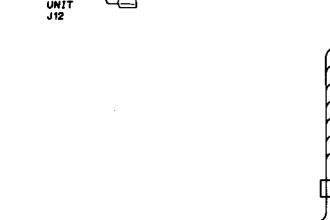
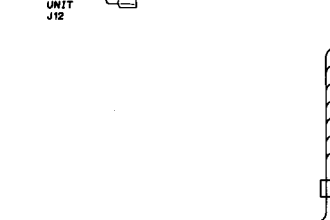
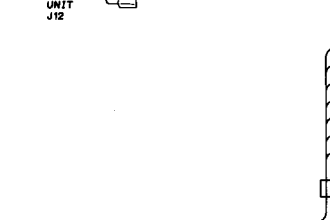
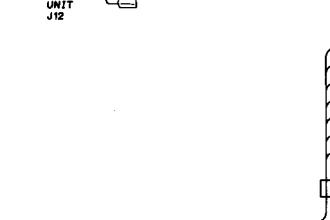
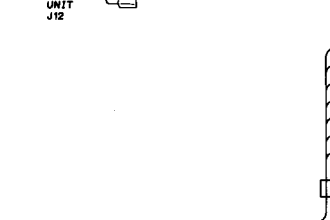
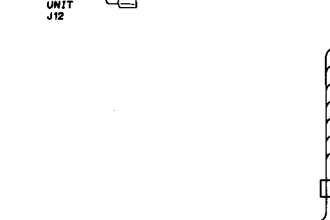
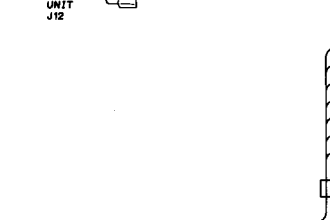
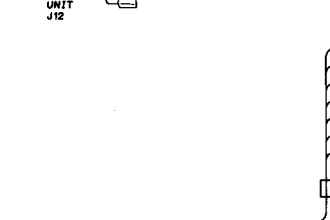
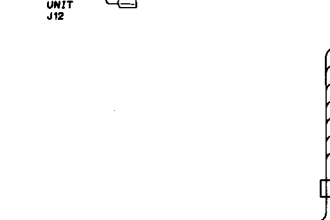
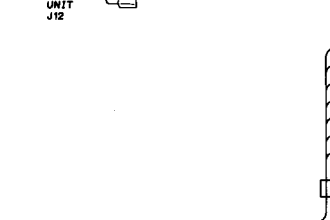
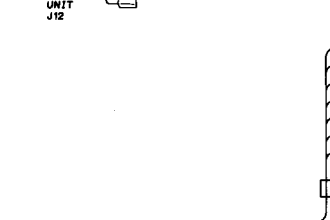
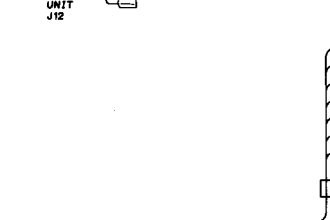
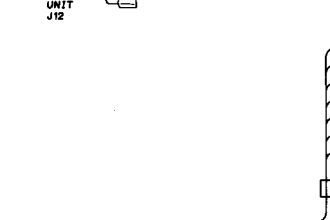
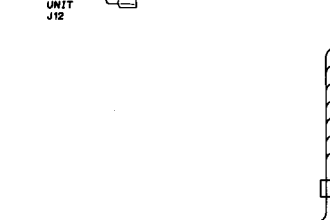
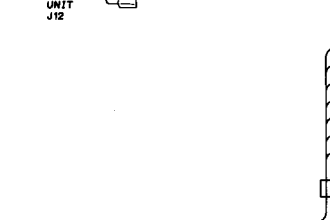
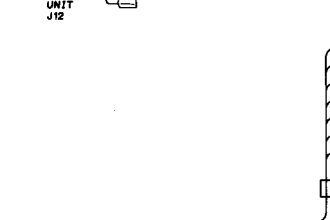
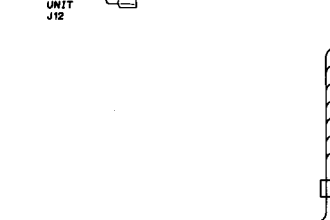
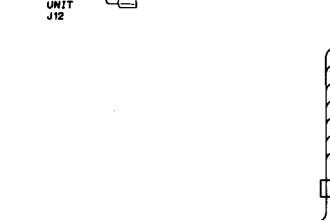
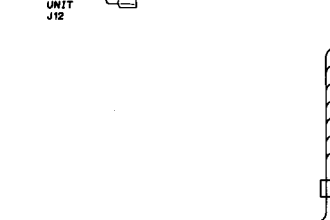
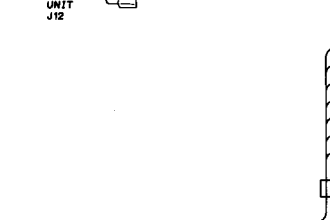
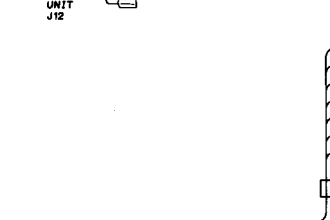
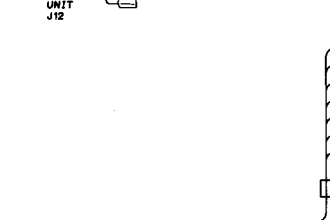
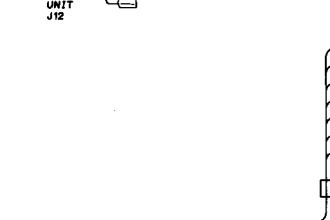
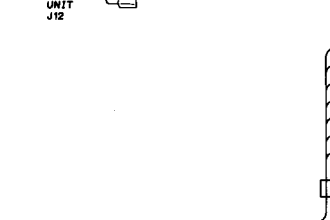
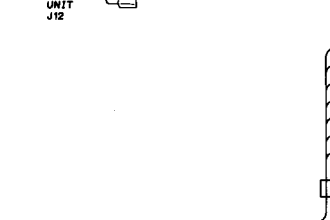
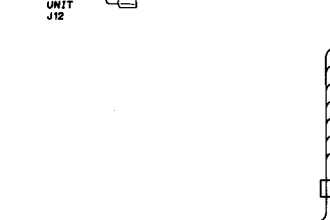
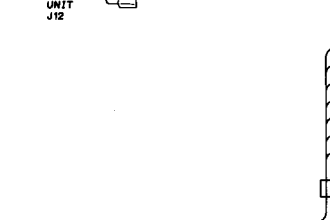
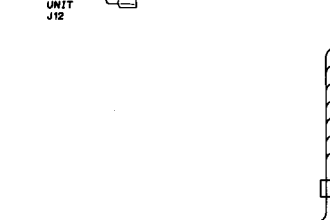
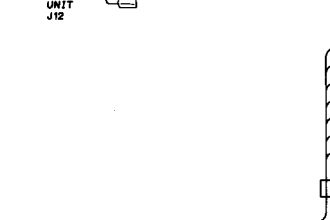
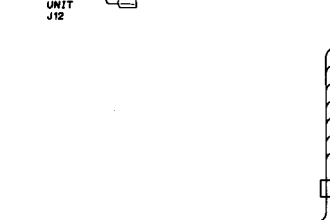
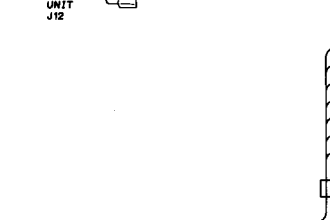
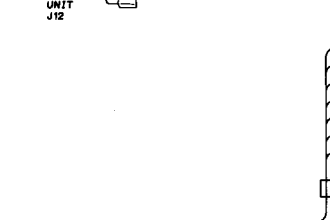
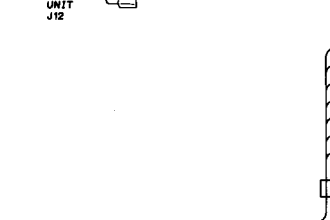
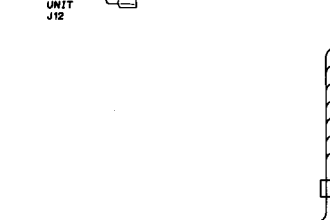
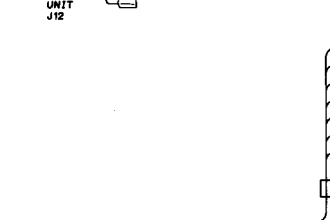
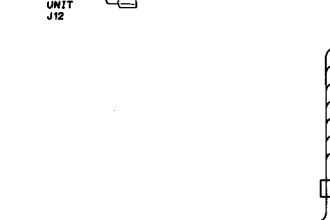
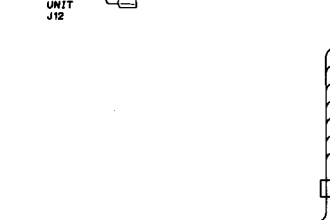
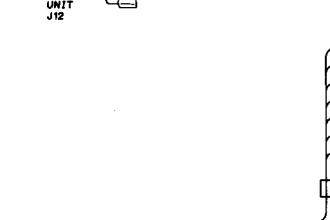
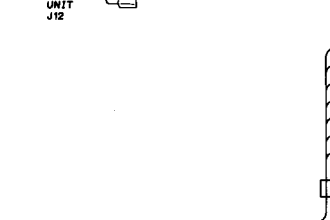
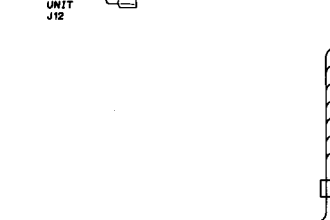
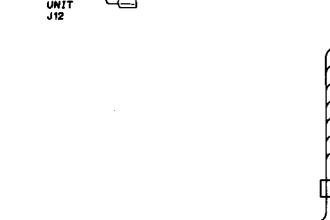
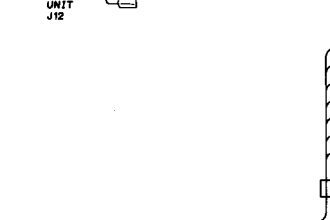
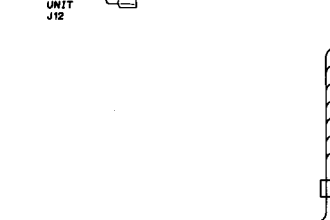
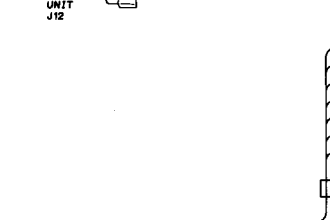
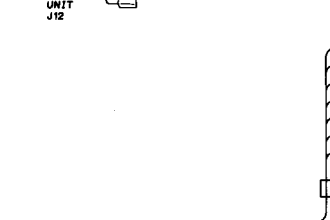
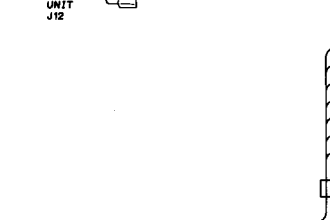
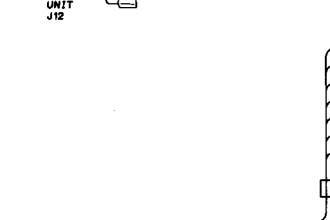
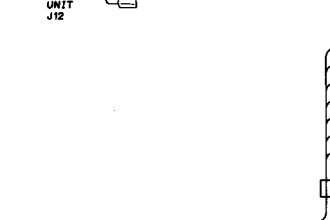
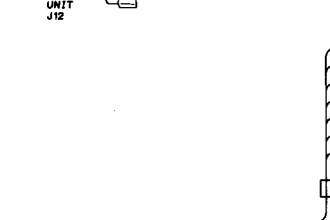
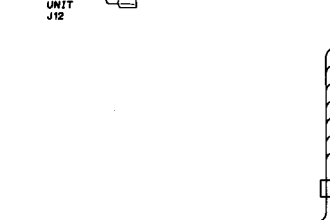
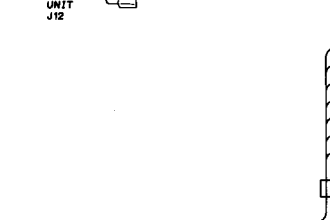
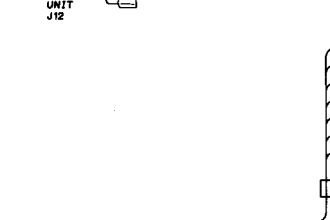
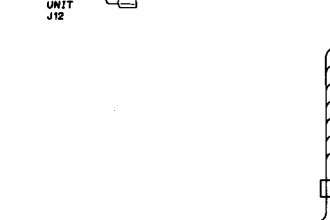
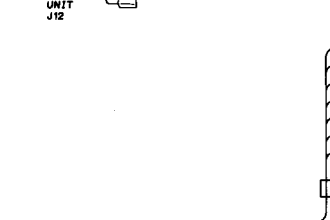
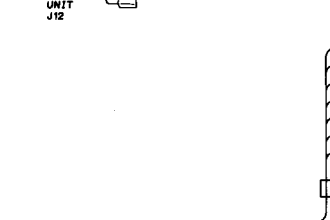
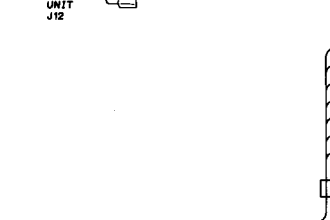
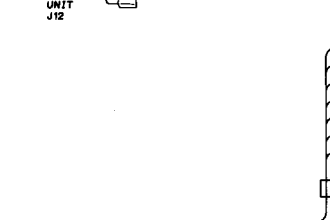
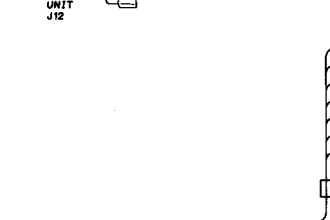
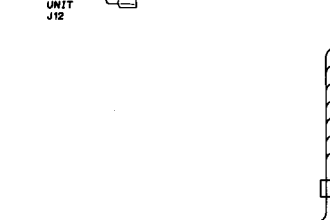
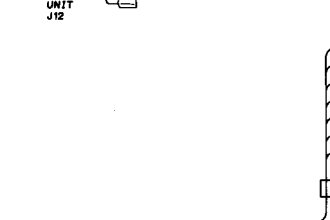
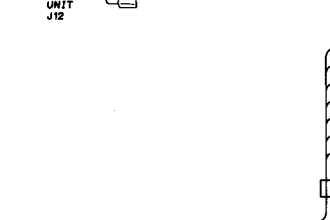
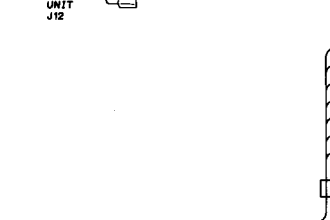
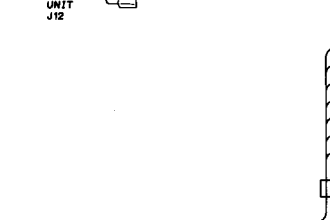
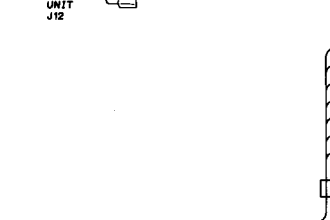
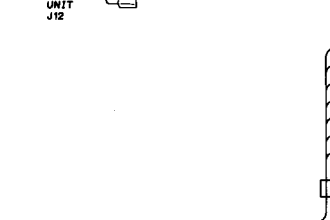
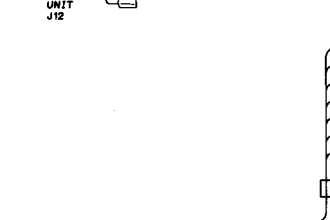
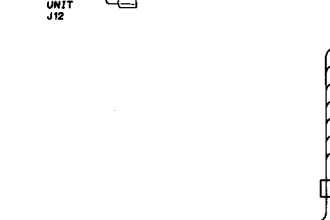
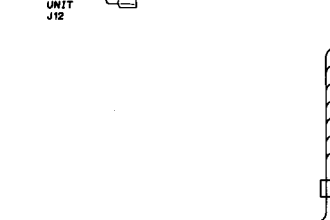
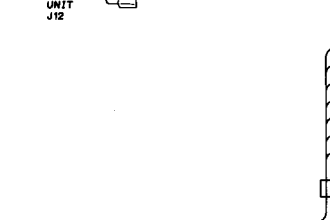
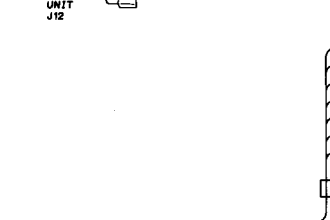
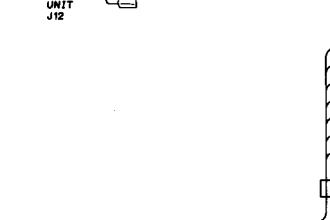
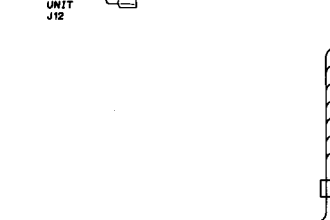
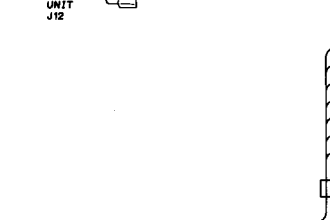
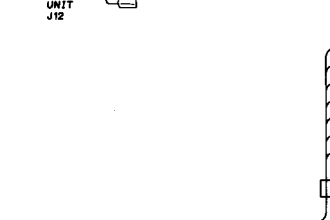
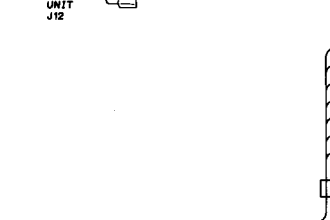
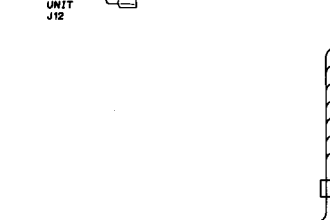
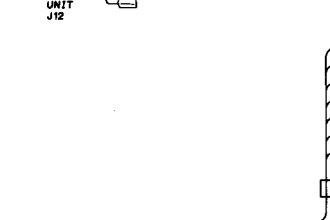
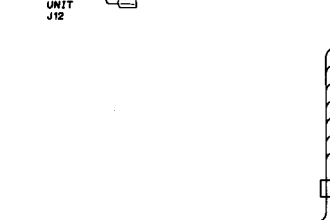
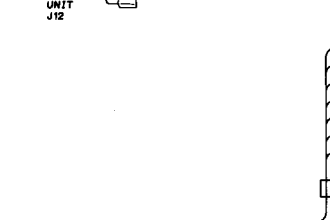
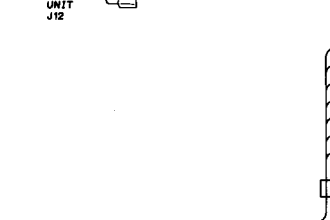
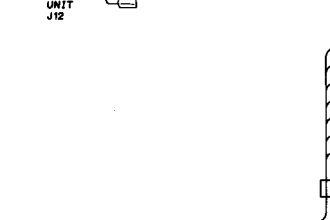
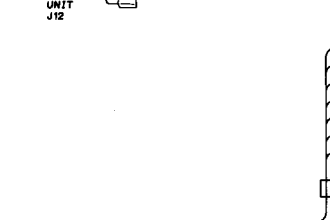
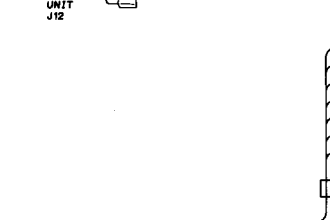
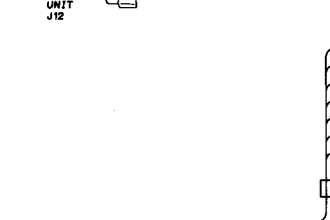
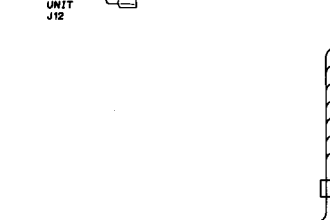
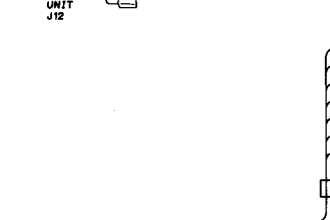
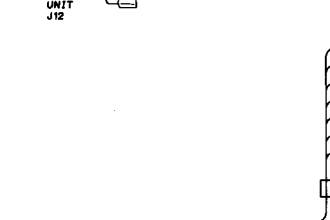
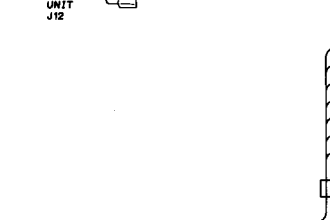
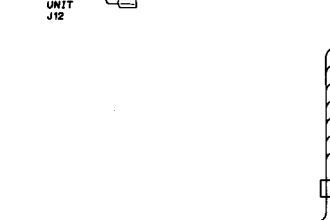
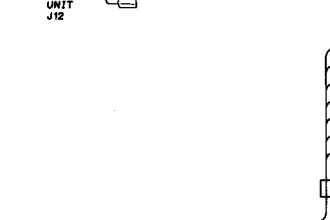
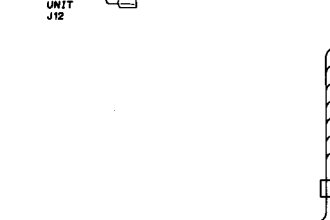
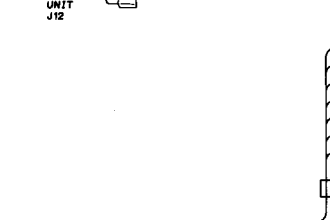
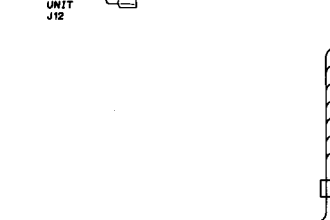
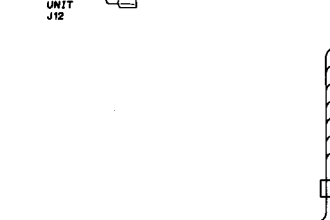
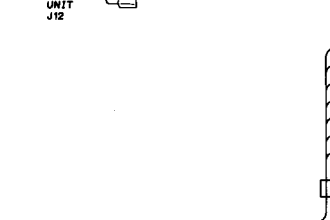
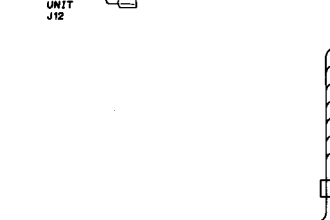
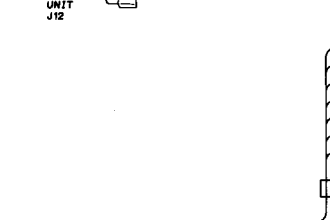
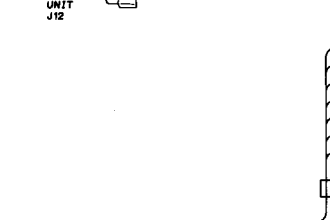
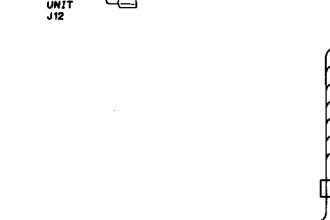
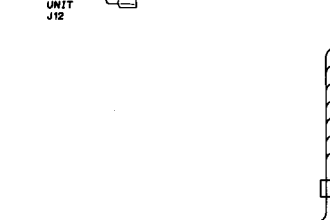
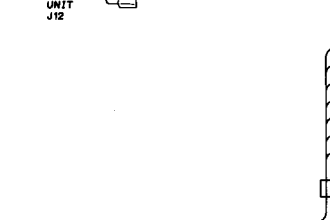
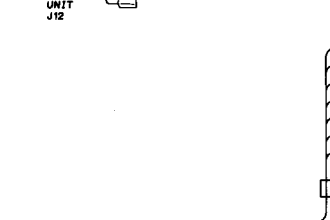
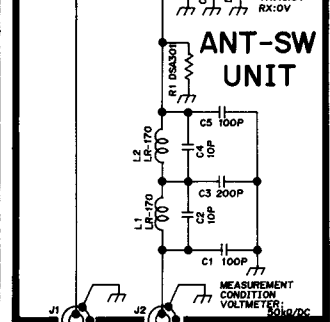
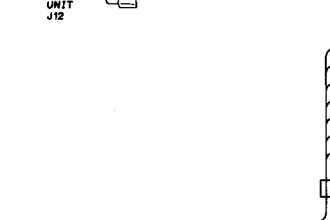
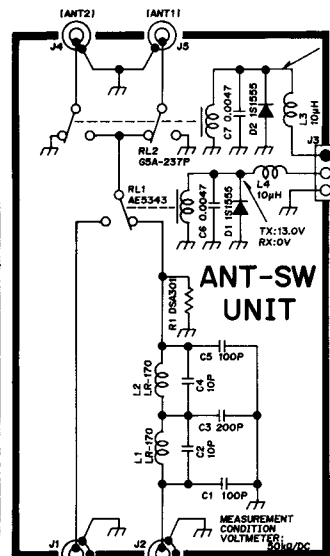
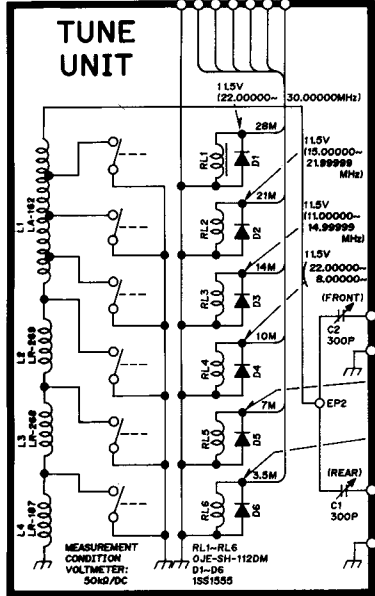

SWR BOARD

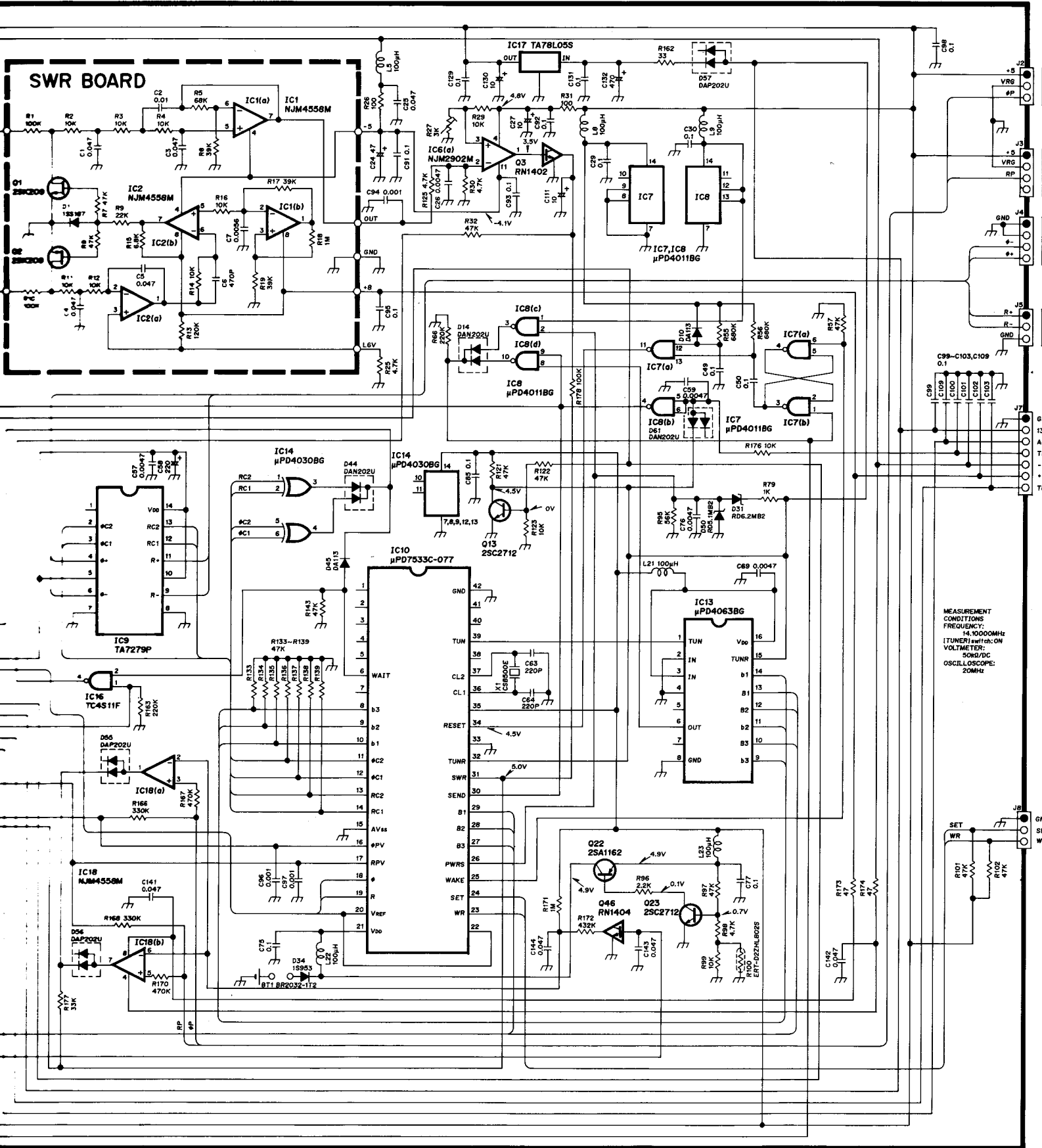

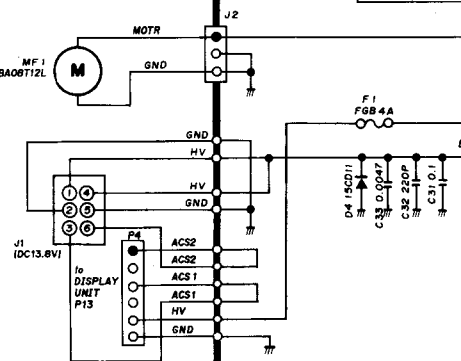
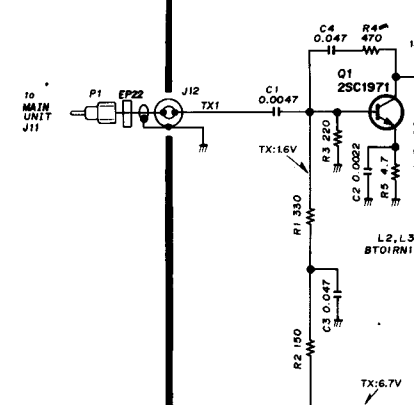
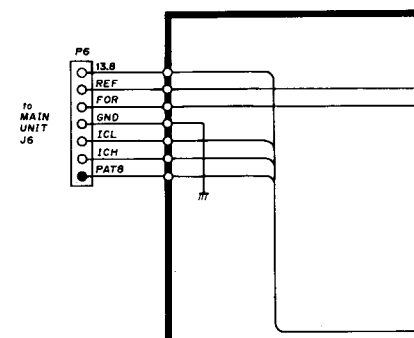
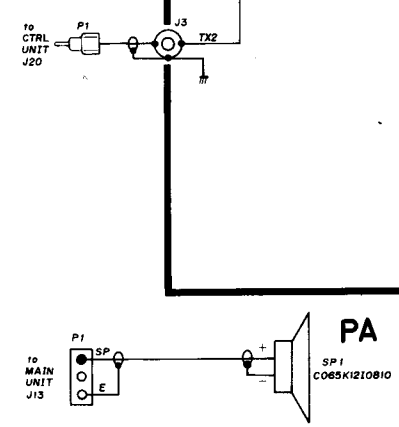
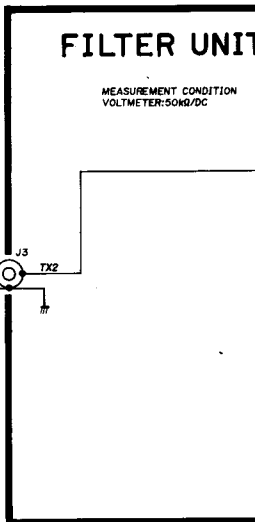
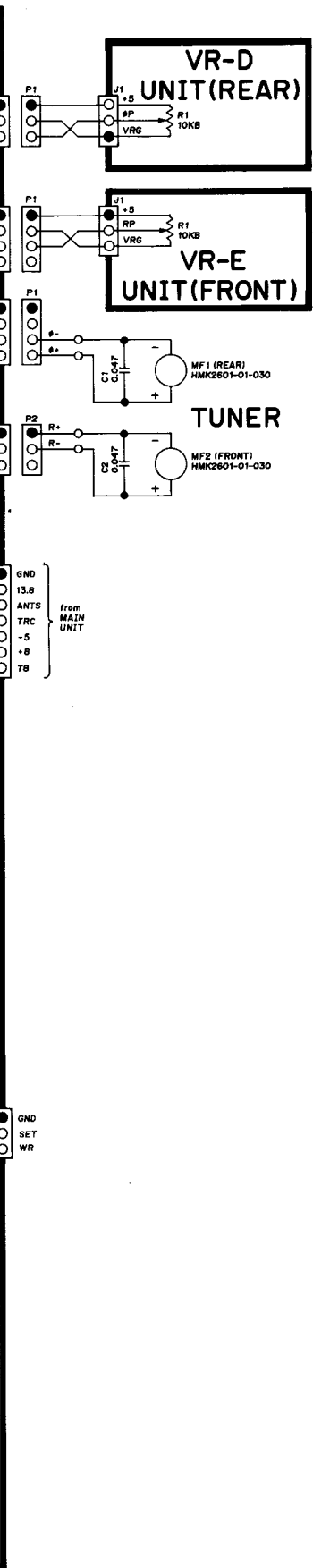
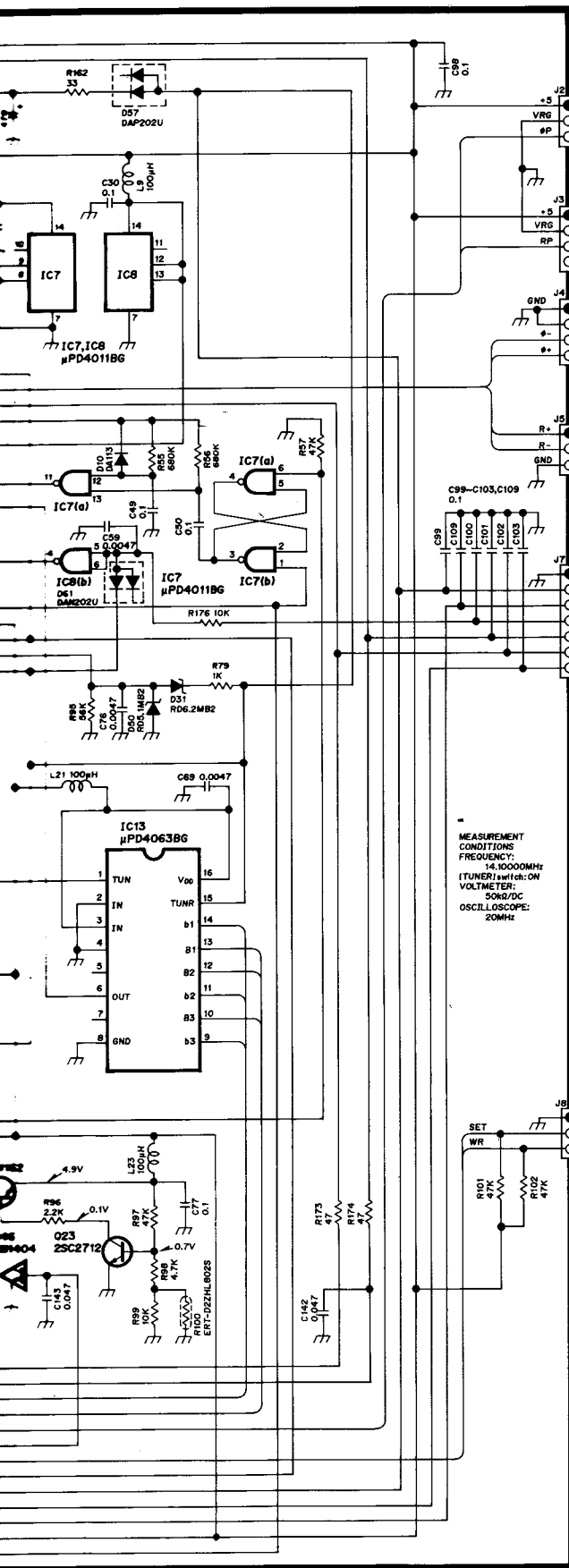

FILTER UNIT

MEASUREMENT CONDITION
VOLTMETER:50KR/DC

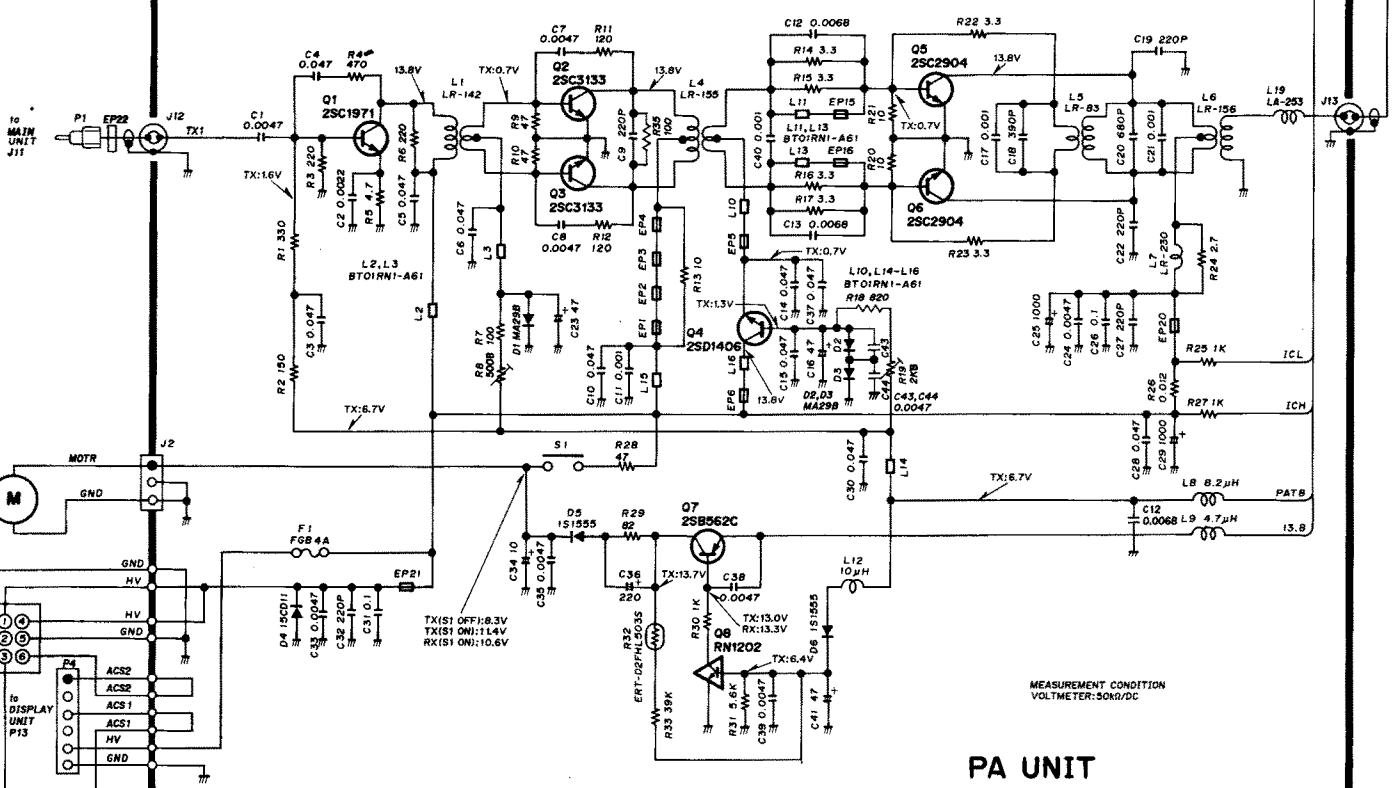
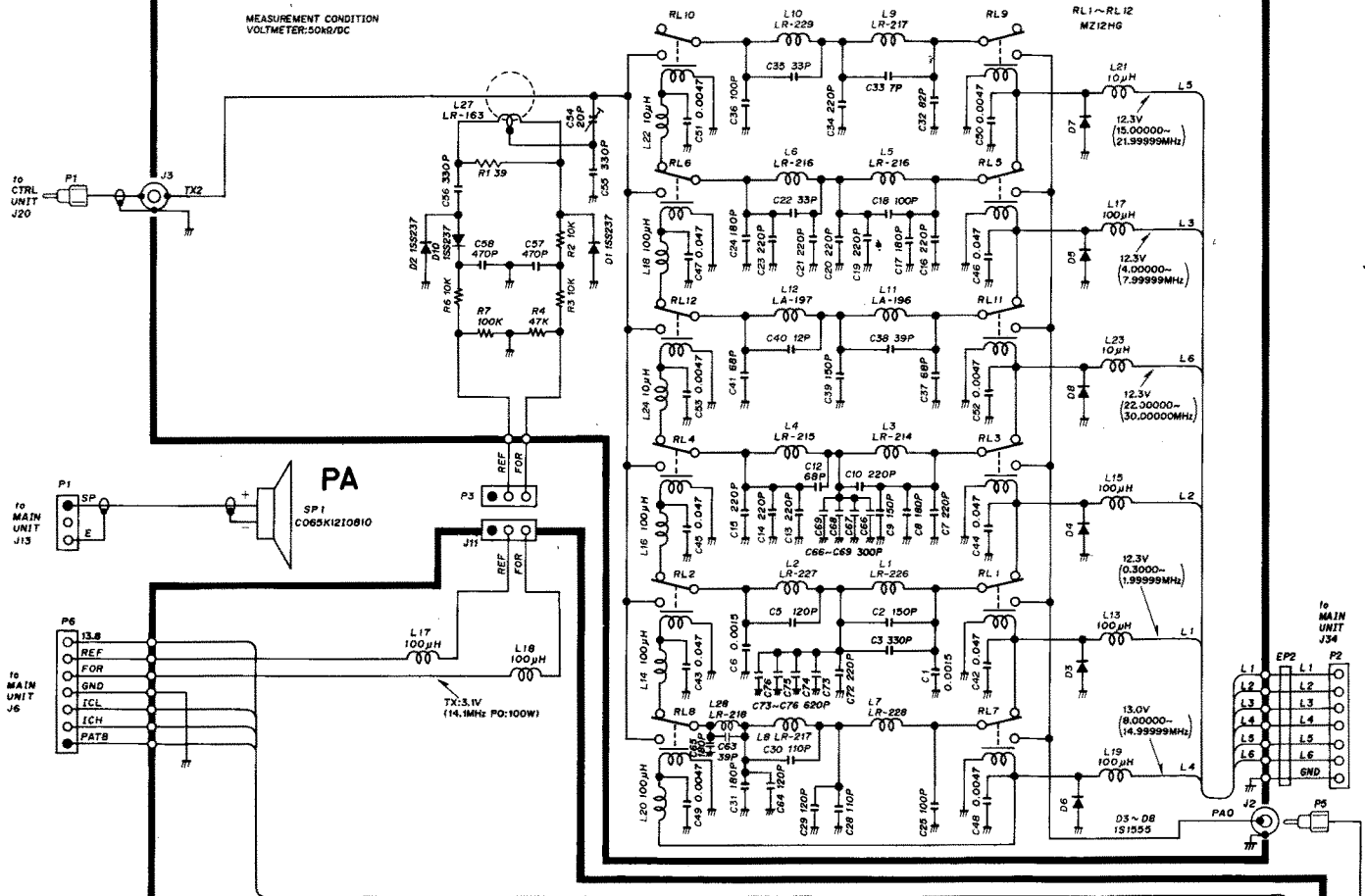

PA UNIT

MEASUREMENT CONDITION
VOLTMETER:50KR/DC

Icom Inc.

6-9-16, Kamihigashi, Hirano-ku, Osaka 547, Japan

Phone: 06 793 5302

Fax : 06 793 0013

Telex : 05277822 ICOMTR J

Icom America Inc.

<Corporate Headquarters>

2380 116th Avenue N.E., Bellevue, WA 98004, U.S.A.

Phone : (206) 454-8155

Fax : (206) 454-1509

Telex : 152210 ICOM AMER BVUE

<Customer Service>

Phone : (206) 454-7619

<Regional Customer Service Centers>

18102 Sky Park South, Suite 52-B, Irvine, CA 92714, U.S.A.

Phone : (714) 852-8026

Fax : (714) 852-8716

1777 Phoenix Parkway, Suite 201, Atlanta, GA 30349, U.S.A.

Phone : (404) 991-6166

Fax : (404) 991-6327

Icom Canada

A Division of Icom America Inc.

3071 #5 Road, Unit 9, Richmond, B.C., V6X 2T4, Canada

Phone : (604) 273-7400

Fax : (604) 273-1900

Icom (Europe) GmbH

Communication Equipment

Himmelgeister Str. 100, 4000 Düsseldorf 1, F.R.G.

Phone : 0211 346047

Fax : 0211 333639

Telex : 8588082 ICOM D

Icom (Australia) Pty. Ltd.

A.C.N 006 092 575

7 Duke Street, Windsor, Victoria, 3181, Australia

Phone : 03 529 7582

Fax : 03 529 8485

Telex : AA 35521 ICOM AS

Icom (UK) Ltd.

Unit 9, Sea St., Herne Bay, Kent, CT6 8LD, U.K.

Phone : 0227 741741

Fax : 0227 741742

Telex : 965179 ICOM G

Icom France S.a

Zac de la Plaine, Rue Brindejonc des Moulinais

BP 5804, 31505 Toulouse Cedex, France

Phone : 61. 36. 03. 03 Fax : 61. 34. 05. 91

Telex : 521515 ICOM FRA

Count on us!